

640

GEOPHYSICAL REPORT  
ON MAKAOO GROUP OF CLAIMS  
FOR  
ROLLING HILLS COPPER MINES LIMITED (N.P.L.)

Claims Surveyed:

C.G. Mineral Claims Lots 2565, 2564, 2563, 2562 and 2561

Mineral Claims:

Python #3 to 8 incl., 15 and 16  
Cub #3 to 6 incl. 9 and 10  
Dot #2, 3, and 5  
Nan, Nat, Net  
Static, Coon and Cub Fractionals  
Pye #1 Fr  
Pye #3 to 8 inclusive  
Jet #1 to 6 incl., 8 to 13 incl., 15, 17, and 19  
Jet #7 Fr, 14 Fr, 16 Fr, and 18 Fr  
Trough #1 Fr to 3 Fr incl.  
Line #1 to 4 incl.  
Queen #1 Fr  
Top #1  
Top #2 Fr and 3 Fr  
Colt #1 to 5 incl.  
Guerin #1 and #2  
RH #1 to 6 incl.  
Kam #1 Fr  
Patricia #1

which are located 7 miles southwest of Kamloops, 50°30', 120°SE

The survey was conducted during the period March 15 to May 1,  
1965.

The report is written by E. B. Nicholls, P.Eng., Geophysicist.

SULMAC EXPLORATION SERVICES LIMITED

MAY 25, 1965

I N D E X

	<u>Page</u>
Introduction	1
Summary and Recommendations	1
Property, Location and Access	2
General Geology	4
Method of Survey	5
Discussion of Results	6

Appendix: List of Personnel Employed on Survey, and Dates

In Pocket: Claim map at scale 1" = 400' (<sup>640-1</sup>2 sheets <sup>640-2</sup>Nest and  
*corresponding* Map of Magnetometer Survey at scale 1" = 400' (<sup>640-3</sup>2 sheets) <sup>640-4</sup>

Department of Mines and Petroleum Resources ASSESSMENT REPORT NO. <u>640</u> MAP
---

GEOPHYSICAL REPORT  
ON MAKAOO GROUP OF CLAIMS  
FOR  
ROLLING HILLS COPPER MINES LIMITED (N.P.L.)  
  
KAMLOOPS MINING DISTRICT  
KAMLOOPS, BRITISH COLUMBIA

Introduction

A ground magnetometer survey was carried out over a group of claims for Rolling Hills Copper Mines Limited, located in the Kamloops area of British Columbia.

The survey was conducted by Sulmac Exploration Services Limited during the period March 15 to May 1, 1965. The field work was carried out by Mr. R. Pild, geophysicist, and Mr. R. McLeod, operator.

Results of the survey are shown on the map accompanying this report.

Summary and Recommendations

A magnetometer survey was carried out over the Makao group of claims for Rolling Hills Copper Mines Limited. The survey did not indicate any major anomalous zone, however

interpretation of the data did give light to the geological pattern of the property. It was possible to indicate the contacts between the various rock types.

The magnetics infer that the claim group is underlain by the Iron Mask Batholith and that rocks of the Kamloops Volcanic Group lie to the east and north of the intrusive. A small band, probably of the Nicola group, lies along the Intrusive-Kamloops contact between line 48W and 36E. These formations are known to be host rocks for ore occurrences in the immediate area.

It is, therefore, recommended that the claim group be surveyed by the Induced Polarization method in order to locate any mineralization that may be present. Any anomalies indicated by the I.P. survey should be further investigated by diamond drilling.

#### Property, Location and Access

The portion of the Rolling Hills Copper Mines Limited property covered by the survey discussed in this report consists of a group of some 73 claims and five Crown Granted mineral claims. These are shown on the accompanying map and are listed as follows:

Crown Granted Mineral Claims, Lots 2565, 2564, 2563, 2562  
and 2561

Mineral Claims, Python #3 to 8 inclusive, 15 and 16  
Cub #3 to 6 inclusive, 9 and 10  
Dot #2, 3, and 5  
Nan  
Nat  
Net  
Static Fractional  
Coon Fractional  
Cub Fractional  
Pye #1 Fr  
Pye #3 to 8 inclusive  
Jet #1 to 6 inclusive, 8 to 13 inclusive,  
15, 17, and 19  
Jet #7 Fr, 14 Fr, 16 Fr, and 18 Fr  
Trough #1 Fr to 3 Fr inclusive  
Line #1 to 4 inclusive  
Queen #1 Fr  
Top #1  
Top #2 Fr and 3 Fr

Colt #1 to 5 inclusive

Guerin #1 and #2

RH #1 to 6 inclusive

Kam #1 Fr

Patricia #1

The property is located some 10 miles by road southwest of Kamloops. Access to the claims is good, being by the main Trans-Canada Highway west from Kamloops for about 7 miles to junction of the Lac Le Jeune road and thence south for approximately 2 miles.

#### General Geology

This area is part of the Interior Plateau region and contains rocks ranging in age from Triassic to Recent. The general geology of the area is shown on Map No. 886A accompanying Memoir 249, Geology and Mineral Deposits of Nicola Map Area, British Columbia, by W. E. Cockfield, published by Department of Mines and Resources.

The property discussed in this report lies within the area underlain by the Iron Mask Batholith. This diorite complex, some 12 miles by 3 miles in area, strikes northwesterly and is found to be the main ore host. To the

north this batholith is bounded by volcanics and to the south by Nicola volcanics with some sediments. The batholith varies in composition from syenite to ultrabasic types, all of which are deficient in quartz, but magnetite and apatite are present in most rocks. This batholith has been subject to considerable movement and shows extensive fracturing. Shearing is found to be maximum in the area of major peridotite inclusions.

All points in the intrusive are favourable for ore occurrence. Showings have been found in the following claims in the immediate area: Iron Cap, Lucky Strike, Evening Star, Iron Mask, Python and Copperhead.

The volcanics are also common hosts to ore filled shears which are not too far from the intrusive. There appears to be close association between copper deposits and certain veins of magnetite within the rocks of the batholith. However, this association of copper and magnetite is not general throughout the area.

#### Method of Survey

The magnetometer survey carried out over the claim group discussed in this report was based on a grid system of 400 foot lines and 100 foot stations. The baseline of the

grid was established in an east-west direction and the traverse lines were turned off at right angles to this line. A total of 66.9 miles were cut and chained.

The survey was conducted using a Sharpe MP-1 Fluxgate magnetometer. The sensitivity of the instrument was 20 gammas per division on the 1000 gamma scale. A total of 63.9 miles were surveyed by this method. The results obtained were plotted on a map at a scale of 400 feet to the inch and contoured. The map accompanies this report.

#### Discussion of Results

The magnetometer survey indicates considerable magnetic relief throughout the property, however no major anomalous zone was found. The magnetite concentration within the area is very erratic. Contacts between the various rock types have been inferred from the magnetics and are shown on the accompanying map. Four probable faults are also shown on the map, however a number of minor faults indicated by the magnetics are not shown.

The zones of magnetic 'highs' indicate the presence of the Iron Mask Intrusive. To the north and east



of this intrusive lies a zone of low magnetics which is probably due to the Kamloops Group. Between lines 48W and 36E along the contact of the Kamloops Volcanics and Iron Mask Intrusive is a zone of intermediate magnetics which is due, in all probability, to the Nicola series.

The magnetics have, therefore, indicated that the claim group is located in a favourable geological environment, as the rocks underlying the property are known to be the host for ore occurrences in the immediate vicinity. Further exploration work in the form of an I.P. survey, followed by diamond drilling, should be undertaken.

Respectfully submitted,

SULMAC EXPLORATION SERVICES LIMITED

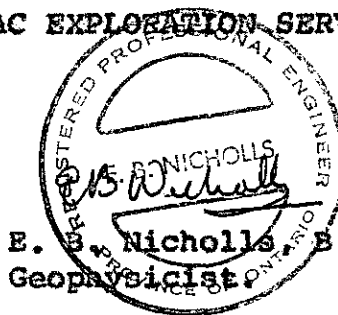

E. S. Nicholls, B.Sc., P.Eng.,  
Geophysicist

May 25, 1965

APPENDIX

List of Personnel Employed on Survey, and Dates:

E. B. Nicholls	Senior Geophysicist	Feb. 16, May 1, 13, 18-20, 1965
R. Pild	Field Geophysicist	March 15 - May 1, 1965
R. McLeod	Geophysical Operator	March 15 - May 1, 1965
D. Grant	Draftsman	April 20, 21, May 18-21, 1965
P. Tapson	Draftsman	April 14, 15, May 10 & 12, 1965
K. Schulte	Linecutter	Jan. 3 - 14 and Feb. 1 - 28, 1965
G. Espaniel	"	" "
R. Espaniel	"	" "
P. Jones	"	" "
T. Reid	"	" "
E. Adams	"	" "
N. Stewart	"	" "

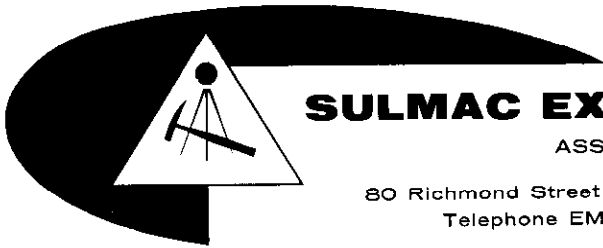

# SULMAC EXPLORATION SERVICES LIMITED

ASSOCIATED WITH VELOCITY SURVEYS LIMITED

80 Richmond Street West, Toronto  
Telephone EM. 4-1401

1323 - 48th Ave. North East, Calgary  
Telephone 277-8556

May 25, 1965

640

## ROLLING HILLS COPPER MINES LIMITED

Linecutting @ 42.5 miles @ \$75.00	\$ 3,187.50
Chaining only - 24.4 miles @ \$40.00	976.00
Magnetometer Survey - 63.9 miles @ \$45.00	2,875.50
Drafting - 70 hours @ \$5.00	350.00
Report writing	400.00
Property visit, E. B. Nicholls	<u>200.00</u>
	<u>\$ 7,989.00</u>

Certified extract of charges billed to and paid by Rolling Hills Copper Mines Limited relative to geophysical survey carried out on claim group.

\_\_\_\_\_  
Secretary-Treasurer



**ROLLING HILLS COPPER MINES LTD.**  
KAMLOOPS - BRITISH COLUMBIA  
KAMLOOPS - MINING DIVISION

SHEET - 1

**CLAIM MAP**

SULMAC EXPLORATION SERVICES LIMITED  
APR-SEPT-1965  
Scale 1" = 400' Feet  
TO ACCOMPANY REPORT BY E.B. NICHOLS, DATED MAY 25, 1965

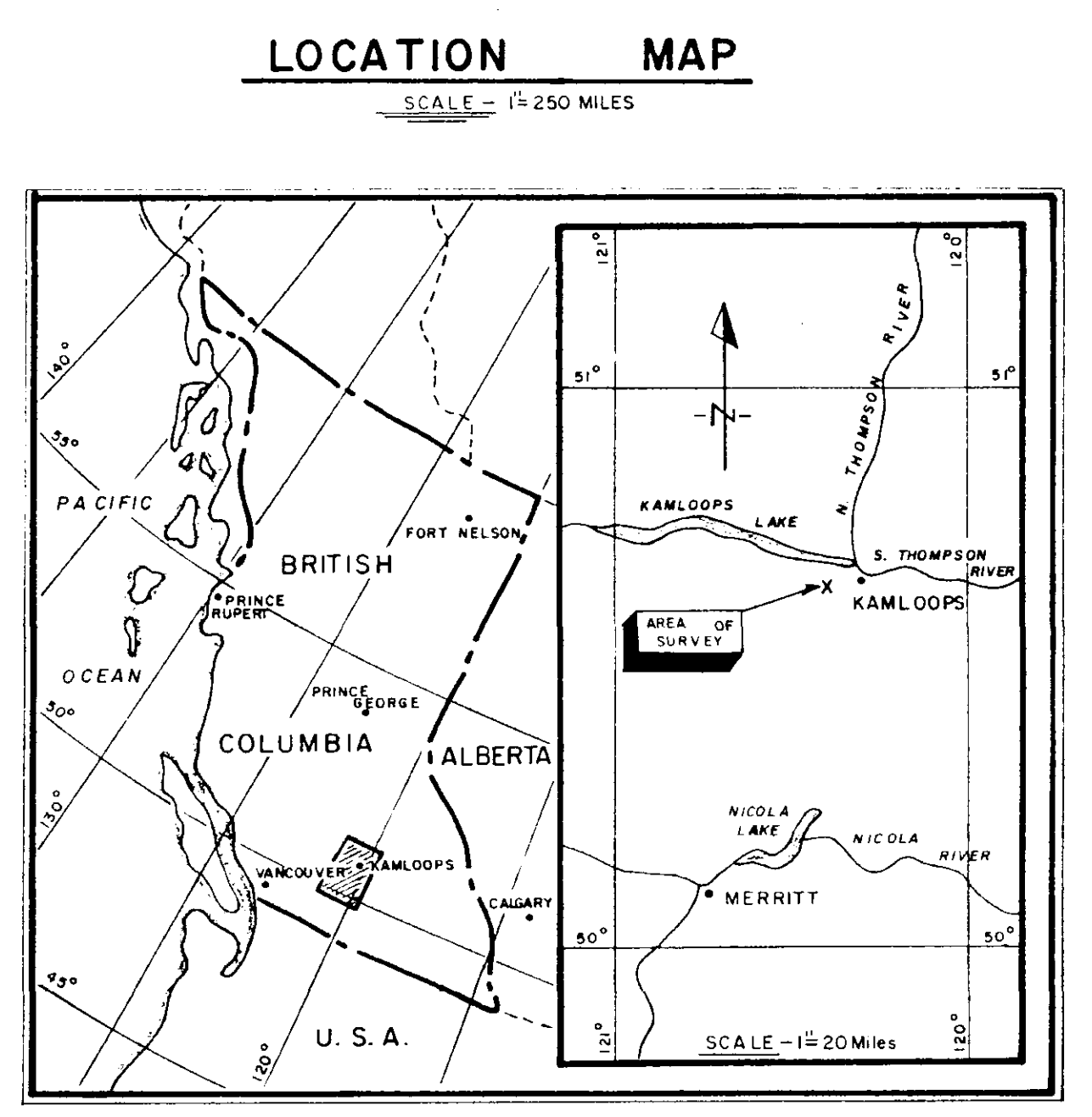
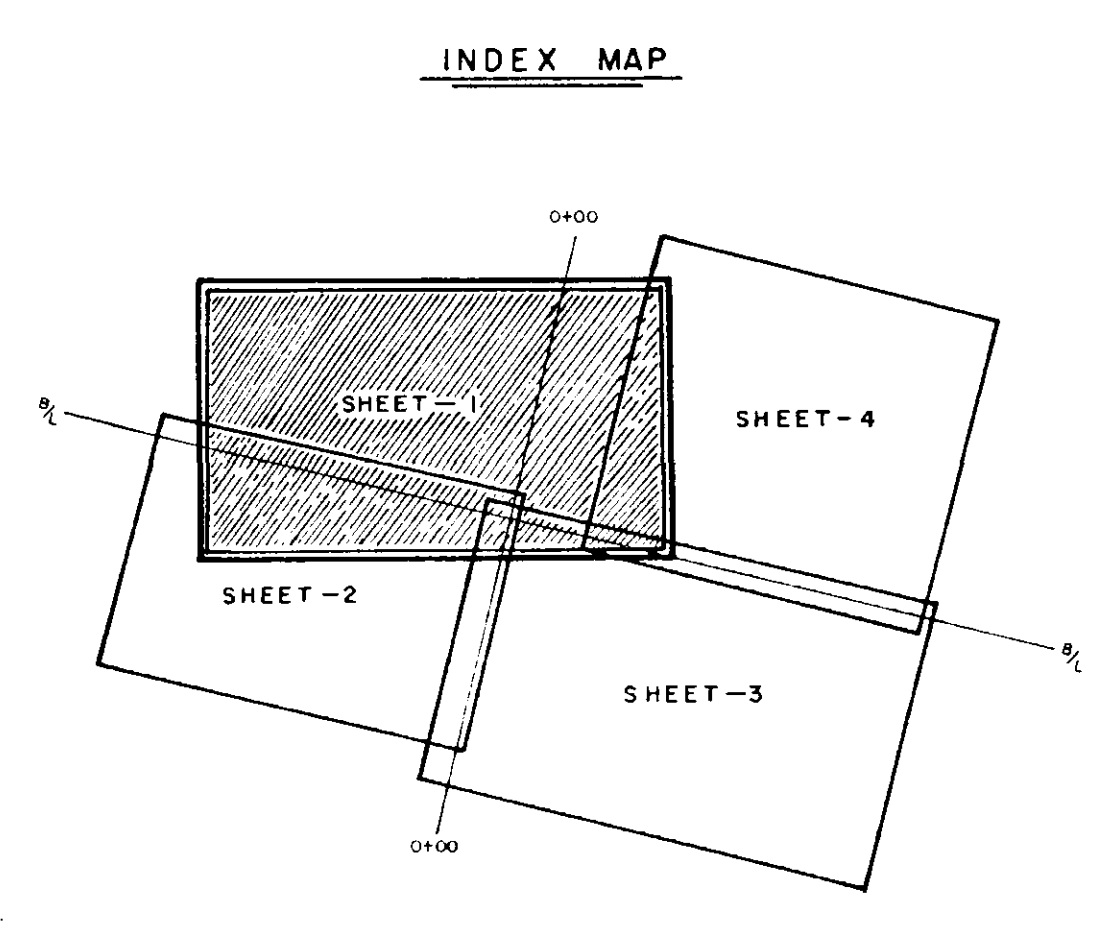

**LEGEND**  
 Claim Boundary ————  
 Property Boundary - - - -  
 Lake Outline ————

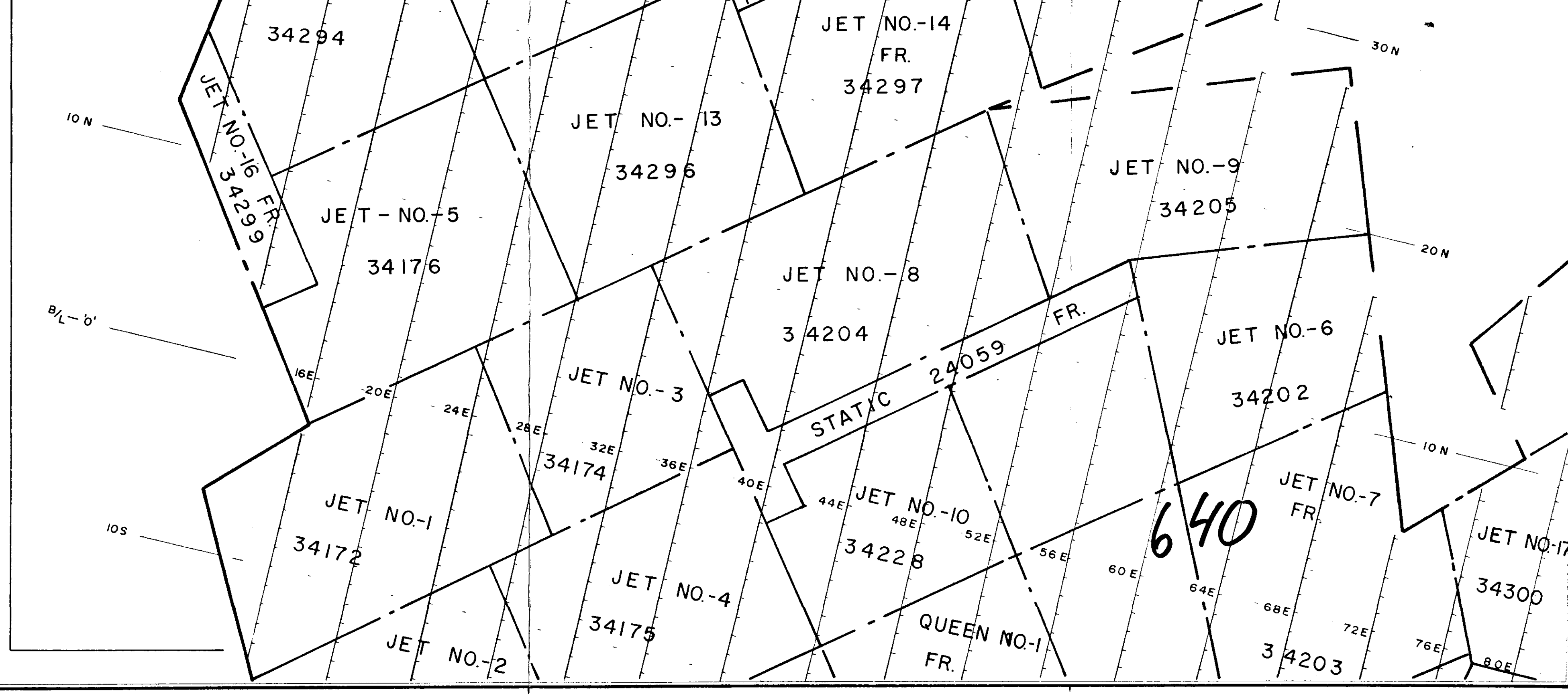

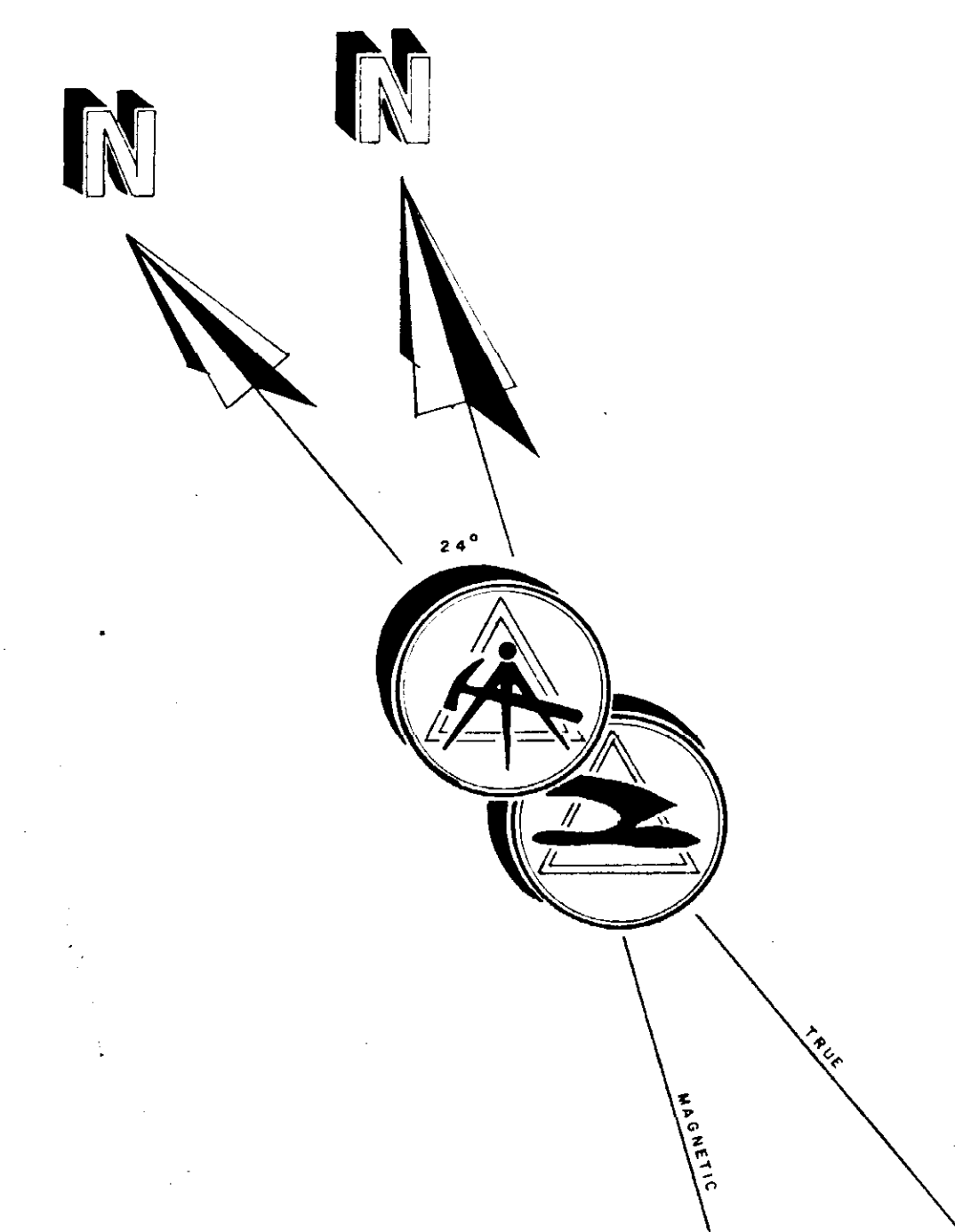


Department of  
Mines and Petroleum Resources  
ASSESSMENT REPORT  
NO. 640 MAP 2

**L E G E N D**

- Claim Boundary ————
- Property Boundary - - - - -
- Lake Outline ————

**LOCATION MAP**

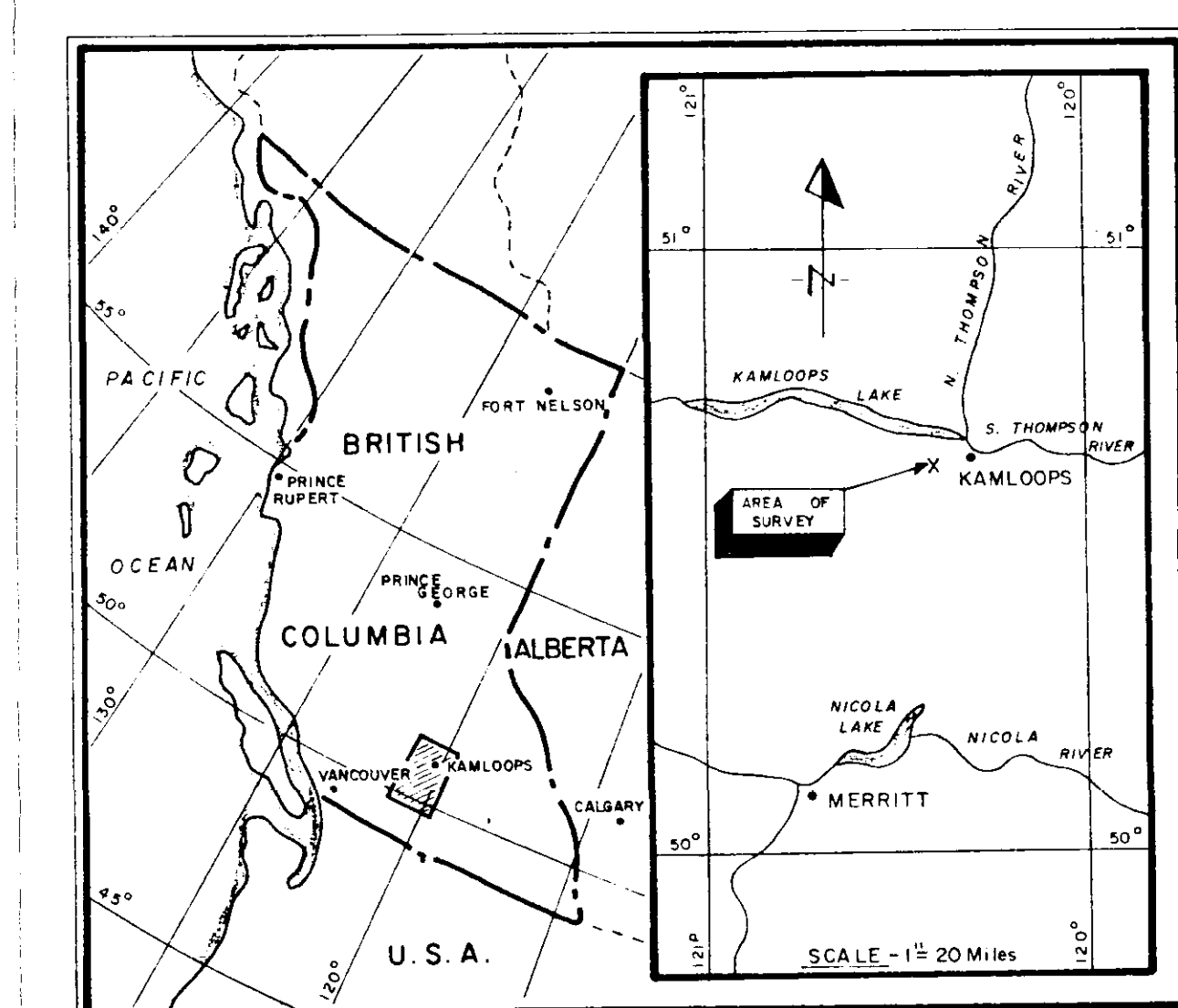

**INDEX MAP**

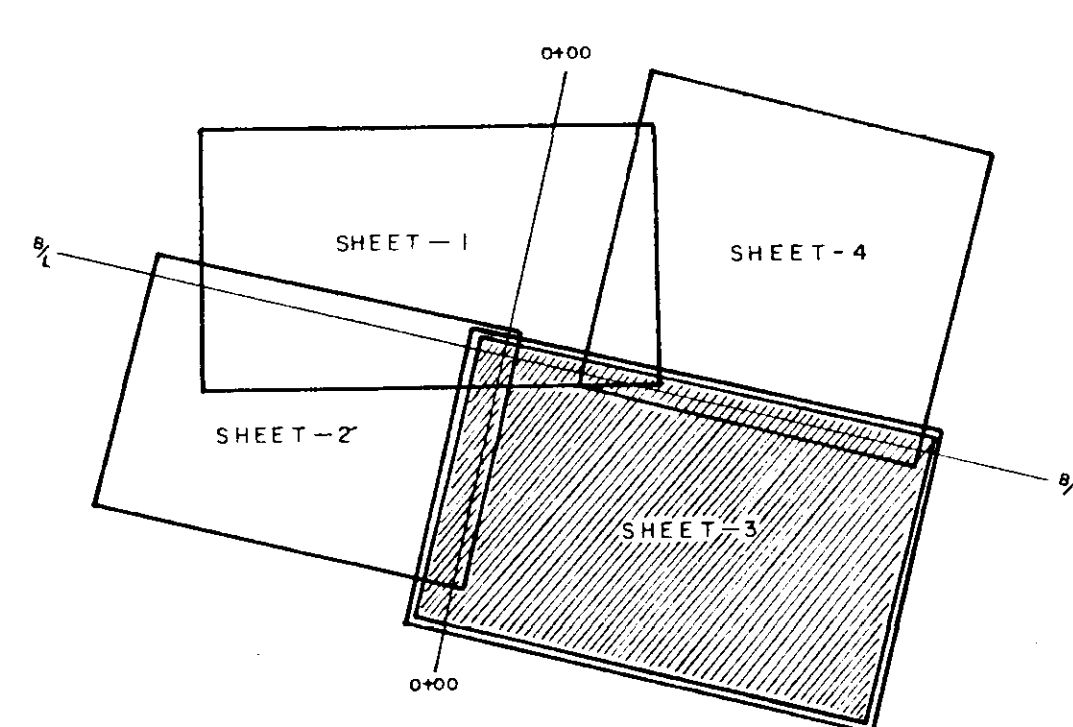

**ROLLING HILLS COPPER MINES LTD**  
KAMLOOPS - BRITISH COLUMBIA  
KAMLOOPS - MINING DIVISION

**SHEET - 3**

**CLAIM MAP**

**640**

SULMAC EXPLORATION SERVICES LIMITED  
APR-SEPT - 1965

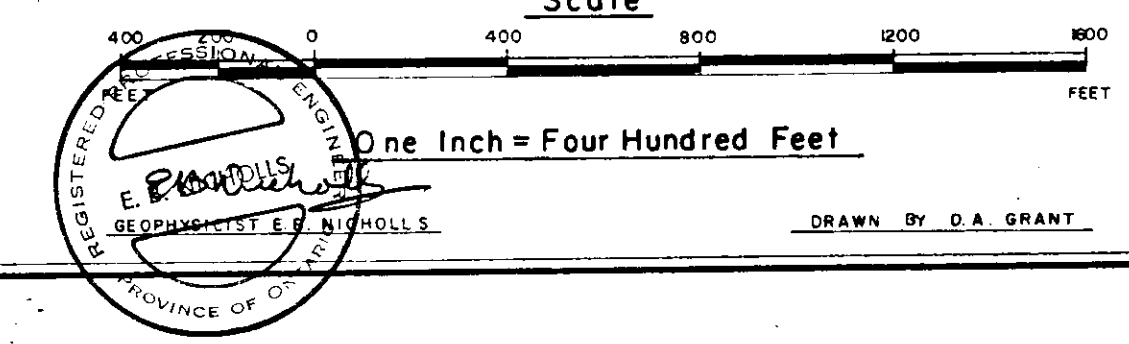

TO ACCOMPANY REPORT BY E.B. NICHOLLS, DATED MAY 25, 1965

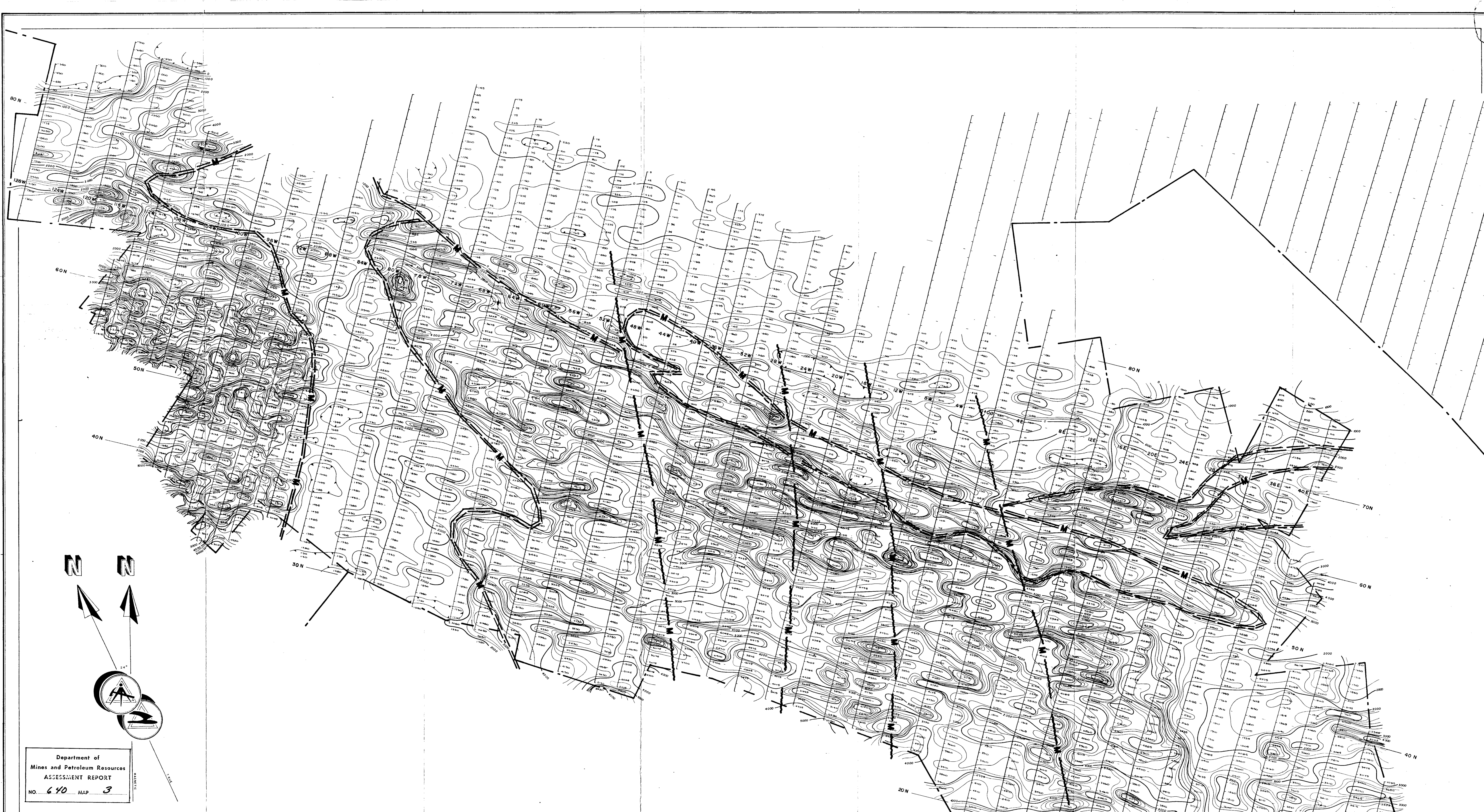

Department of  
Mines and Petroleum Resources  
ASSESSMENT REPORT  
NO. 640 MAP 3

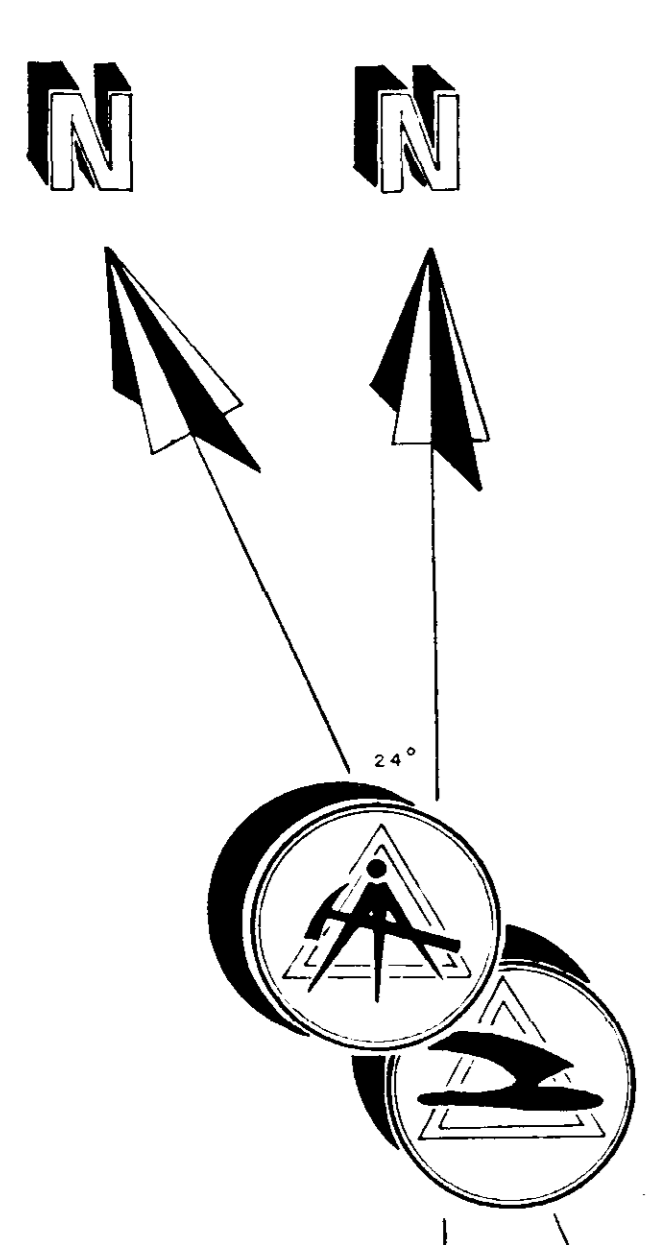

ROLLING HILLS COPPER MINES LTD.  
KAMLOOPS - BRITISH COLUMBIA  
KAMLOOPS - MINING DIVISION

SHEET - 1

**MAGNETOMETER SURVEY**

SULMAC EXPLORATION SERVICES LIMITED  
APR-SEPT - 1965  
Scale  
One Inch = Four Hundred Feet  
DRAWN BY: D. A. CRANT

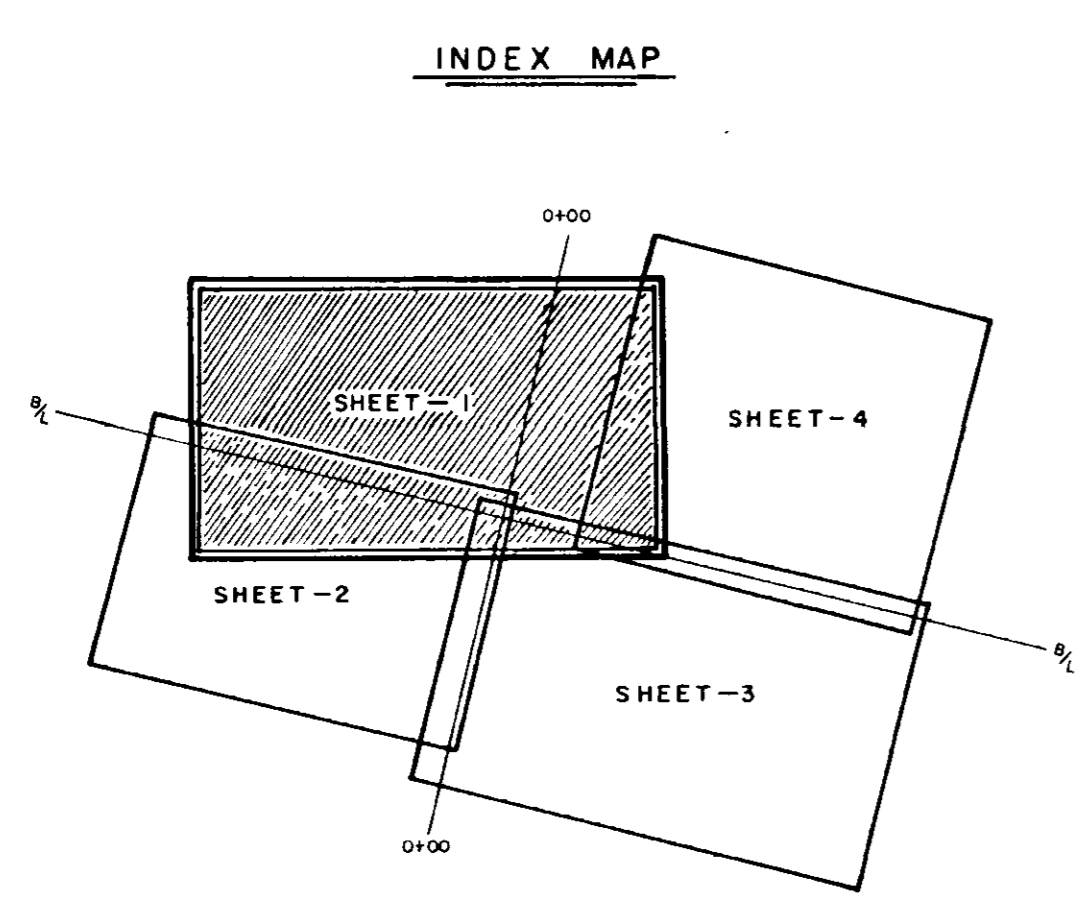

**LOCATION MAP**  
SCALE - 1:250 MILES

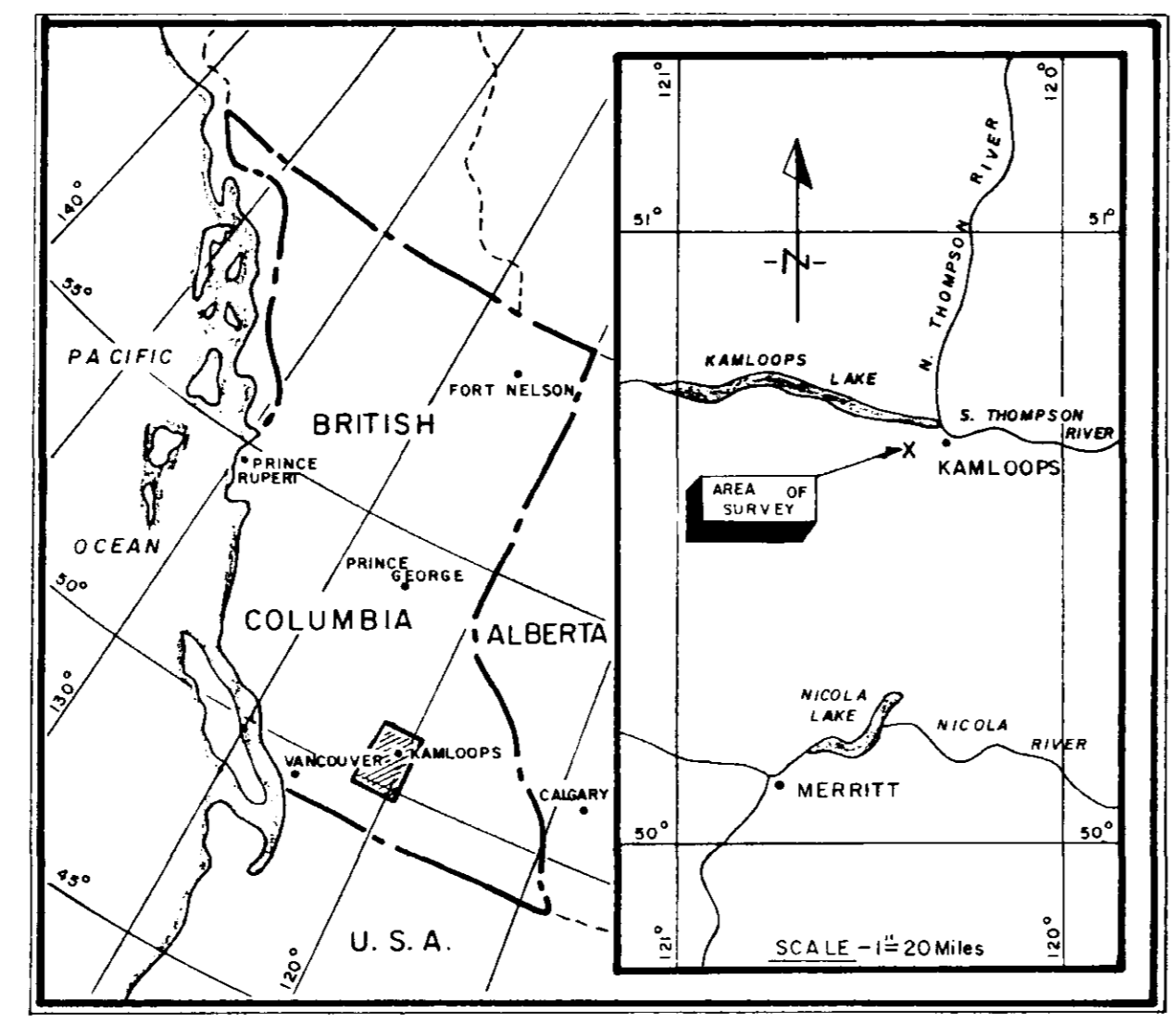

**L E G E N D**

- MAGNETOMETER SURVEY**  
Contour Interval 250 Gammas  
1000 Gamma Contour  
250 Gamma Contour  
Magnetic Depression
- MAP SYMBOLS**  
Property Boundary  
Contact Inferred from Magnetics  
Fault Inferred from Magnetics

640

TO ACCOMPANY REPORT BY E. B. NICHOLLS, DATED MAY 25, 1965



Department of  
Mines and Petroleum Resources  
ASSESSMENT REPORT  
NO. 640 M.P. 4

ROLLING HILLS COPPER MINES LTD.  
KAMLOOPS-BRITISH COLUMBIA  
KAMLOOPS-MINING DIVISION

SHEET-3

MAGNETOMETER  
SURVEY

640

SULMAC EXPLORATION SERVICES LIMITED  
APR-SEPT-1965

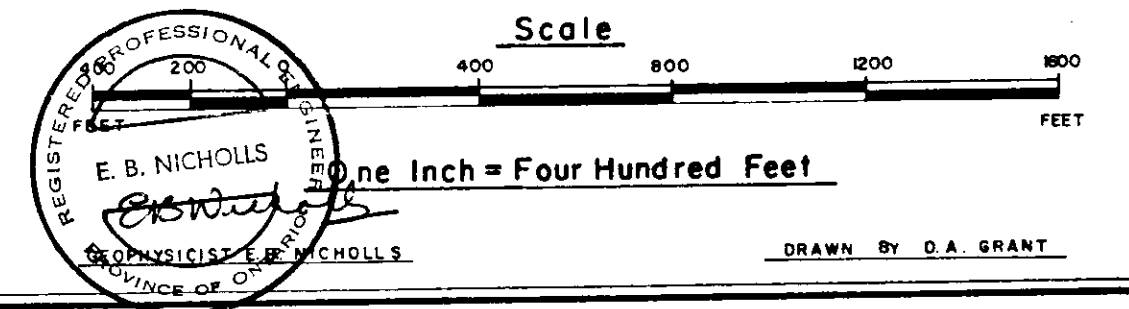

L E G E N D

MAGNETOMETER SURVEY

- Contour Interval 250 Gammas
- 1000 Gamma Contour
- 250 Gamma Contour
- Magnetic Depression

MAP SYMBOLS

- Property Boundary
- Contact Inferred from Magnetics
- Fault Inferred from Magnetics

LOCATION MAP

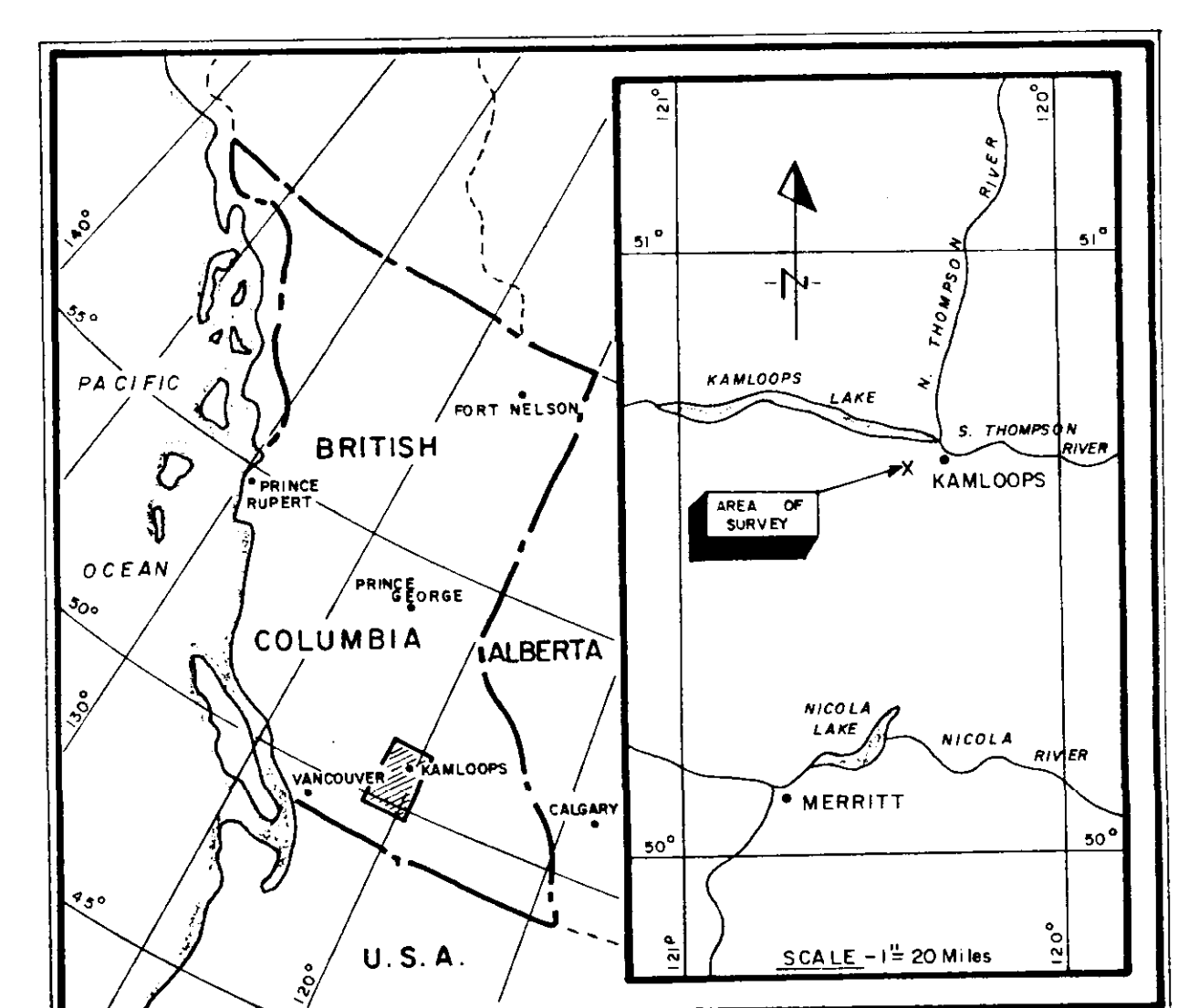

INDEX MAP

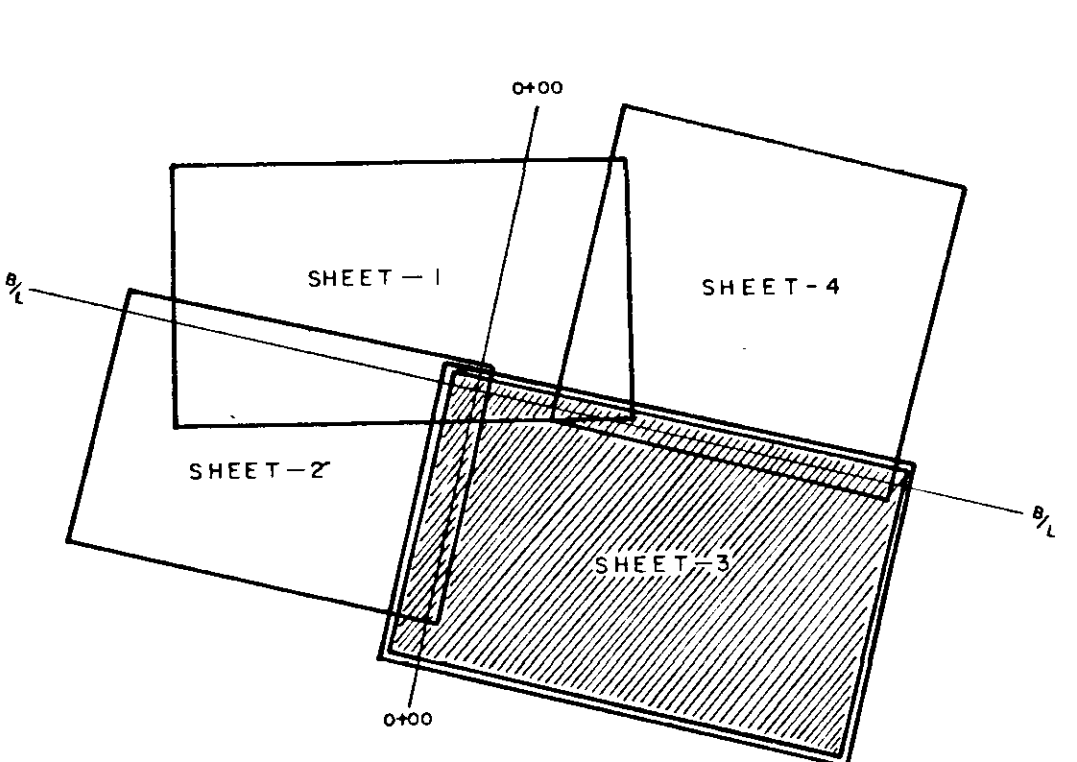

TO ACCOMPANY REPORT BY E. B. NICHOLLS, DATED MAY 25, 1965