

964

REPORT ON INDUCED POLARIZATION SURVEY
HAPPY DAY 1 - 7 (Incl.), RED CHIEF 1 & 2
TOM 1 - 75 (Incl.) & 78 - 93 (Incl.)
CRANBROOK AREA, B. C. 49° 115° N.W.
ON BEHALF OF
CINDY MINES LTD. (N. P. L.)

82G/12E

by

Seigel Associates Limited

Roger W. Gedde, M.Sc.

Richard O. Crosby, P.Eng.

Vancouver, B. C.

April 12, 1967

TABLE OF CONTENTS

	<u>Page No.</u>
Summary	
Introduction	1
Geology	2
Discussion of Results	3
Affidavit of Expenditures	4
In Envelope:	
/ Plate 1 - Line map and Claim map	
2 Plate 2 - Chargeability & resistivity profiles	

S U M M A R Y

The induced polarization survey covered three adjacent lines on the property. In the vicinity of these lines, the chargeabilities observed have indicated the absence of any metallic sulfide mineralization in sufficient quantity to be of probable economic interest.

SEIGEL ASSOCIATES, LIMITED

GEOPHYSICAL CONTRACTORS AND CONSULTANTS

STE. 610, 890 WEST PENDER STREET · VANCOUVER, BRITISH COLUMBIA · CANADA
TELEPHONE: 683-5861 · CABLE: "SEIGEO", VANCOUVER · TELEX: 04-5743

REPORT ON INDUCED POLARIZATION SURVEY CRANBROOK AREA, BRITISH COLUMBIA ON BEHALF OF CINDY MINES LTD. (N. P. L.)

INTRODUCTION:

During the period March 17 through March 24, 1967, a geophysical field party under the direction of Mr. Ken Shields conducted an induced polarization survey on a portion of a property held by Cindy Mines Ltd. (N. P. L.). This property is located five miles northeast of Cranbrook in the Fort Steele Mining Division of British Columbia. The following claims are included in the property:

Happy Day 1 - 7 inclusive

Red Chief 1 & 2

Tom 1 - 75 inclusive

Tom 78 - 93 inclusive

Access to the property is via a gravel road running east from Highway 95, two and one half miles from Cranbrook.

For the present survey, Seigel MK-VB time-domain (pulse-type) induced polarization equipment was employed to measure the chargeability of the subsurface material in the vicinity of the lines surveyed. The accompanying copy of Dr. H. O. Seigel's paper entitled "Three Recent Irish Discovery Case Histories Using Pulse Type Induced Polarization" gives descriptions of the phenomena involved in this type of survey, the instrumentation utilized, the field procedure followed and the response obtained over various base metal deposits.

8

INTRODUCTION: (Continued)

On the present property, lines were cut oriented northerly and spaced at 500 foot intervals. The induced polarization survey covered three adjacent lines, each about one mile in length. (See Plate 1).

The purpose of the survey was to locate and map any conducting sulfides, either massive or disseminated, which may exist in the vicinity of the lines surveyed. The electrode spacing "a" used was 400 feet and readings were taken each 200 feet along the lines.

Some difficulty was encountered during the execution of the survey due to interference from nearby radio transmitters.

GEOLOGY:

The best available published geology of the area is in Memoir 207 of the Geological Survey of Canada by H. M. A. Rice, dated 1937. The property is located on the west side of the Rocky Mountain trench in an area of Precambrian and Cambrian sedimentary rock which have been intruded with numerous dikes and sills of dioritic composition.

On the property copper mineralization is known to exist in the form of sulfides disseminated in a dioritic sill which trends northerly across the property. The copper occurs mainly as chalcopyrite and bornite, with very little associated pyrite.

DISCUSSION OF RESULTS:

The survey data are presented on Plate 2 in profile form. The horizontal scale is 1 inch = 400 feet. The induced polarization response, chargeability, is plotted at a scale of 1 inch = 5 milliseconds. The resistivity scale is 1 inch = 1000 ohm-metres. All chargeabilities measured are less than 2.0 milliseconds. This is well within the normal polarization characteristics for the rock types existing in this area and indicates no conducting sulfides of sufficient volume to be of probable economic interest. The resistivities measured are on the order of 1000 ohm-metres in the south, dropping to 200 - 400 ohm-metres near station 34 North. This suggests a change in lithology or overburden at about 34 North.

The purpose of the present survey was to test the possibility of copper sulfide mineralization at depth in an area of some surface mineral showings and anomalous geochemical copper values. In the vicinity of the lines surveyed, the induced polarization survey has given no indication of substantial sulfide mineralization at depth. However, as only a small portion of the property was covered, one cannot conclude that substantial mineralization does not exist elsewhere on the property.

Respectfully submitted,

SEIGEL ASSOCIATES LIMITED

Roger W. Gedde, M.Sc.
Geophysicist

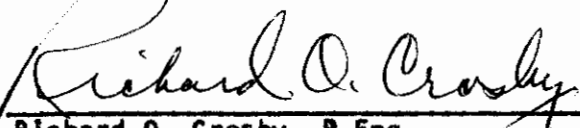
Richard O. Crosby, P.Eng.
Consulting Geophysicist.

AFFIDAVIT OF EXPENDITURE

FOR PROFESSIONAL SERVICES RENDERED

T0: Supply of Induced Polarization unit, operator, and field assistants, Cranbrook, B. C.
March 15 to March 26, 1967

4 field crew days @ \$250.00/day	\$1,000.00
1 standby day @ \$125.00/day	125.00
4 travel days @ \$125.00/day	
3 days not applicable	
	<hr/>
	\$1,625.00

Field Assistants: March 15 to 26, 1967

Alois Albrecht - 12 days	240.00	
Nick Chlopan - 7 days	140.00	
Edward Frost - 7 days	<u>140.00</u>	
	520.00	
Employee Benefits & Office overhead	<u>98.28</u>	618.28

Transportation

12 days truck @ \$ 15.00/day	180.00	
1360 miles @ 15¢/mile	<u>204.00</u>	384.00
Non recoverable electrodes		<u>80.50</u>
		\$2,707.78

And I make this solemn declaration conscientiously believing it to be true, and knowing that it is of the same force and effect as if made under oath and by virtue of the "Canada Evidence Act."

Declared before me at the *City*)
of *Vancouver* , in the)
Province of British Columbia, this *20th*)
day of *April* 1967, A. D.) *Roger W. Steadde*

~~A Commissioner for taking Affidavits for British Columbia or~~
~~A Notary Public in and for the Province of British Columbia.~~
Gold Commissioner

Harold O. Seigel

President,
Harold O. Seigel & Assoc., Ltd.,
Downsview, Ontario

Annual General Meeting,
Toronto, March, 1965

Three Recent Irish Discovery Case Histories Using Pulse-Type Induced Polarization

Transactions, Volume LXVIII, 1965, pp. 343-348

ABSTRACT

In the intensive Irish exploration program which has followed the discovery of the Tynagh deposit (Northgate Exploration, Ltd.) in 1962, three base metal discoveries have been made to date. These include the lead-zinc-silver deposits at Silvermines (Consolidated Mogul Mines, Ltd.), which are now being readied for production, the copper-silver deposit at Gortdrum (Gortdrum Mines, Ltd.) and the lead-zinc deposits near Keel (Rio Tinto-Zinc Ltd.). Each of these discoveries is the result of a combined geological-geochemical-geophysical exploration sequence in which pulse-type induced polarization surveys defined the precise location and lateral extent of the near-surface metallic sulphide mineralization and guided the initial drilling program. Whereas the Silvermines mineralization is, in part, composed of massive sulphides, the other two deposits are characterized by generally less than 5 per cent conducting sulphides and constitute an excellent demonstration of the unique merits of the pulse-type induced polarization system.

Introduction

FOR the benefit of those who are unfamiliar with the induced polarization method in general or with the pulse-type method in particular, a few introductory remarks will be directed on the system employed in the present case histories. Those who wish a fuller treatment of the subject are directed to Seigel (1962),* which paper also includes an extensive list of references.

Induced polarization, in its broadest sense, means a separation of charge to form an effective dipolar (polarized) distribution of electrical charges throughout a medium under the action of an applied electric field. When current is caused to pass across the interface between an electrolyte and a metallic conducting body (Figure 1a) double layers of charge are built up at the interface, in the phenomenon known

*Seigel, H. O., "Induced Polarization and its Role in Mineral Exploration," *C.I.M. Bulletin*, Vol. 55, No. 600, pp. 242-249; *Transactions*, Vol. LXV, pp. 151-158; 1962.

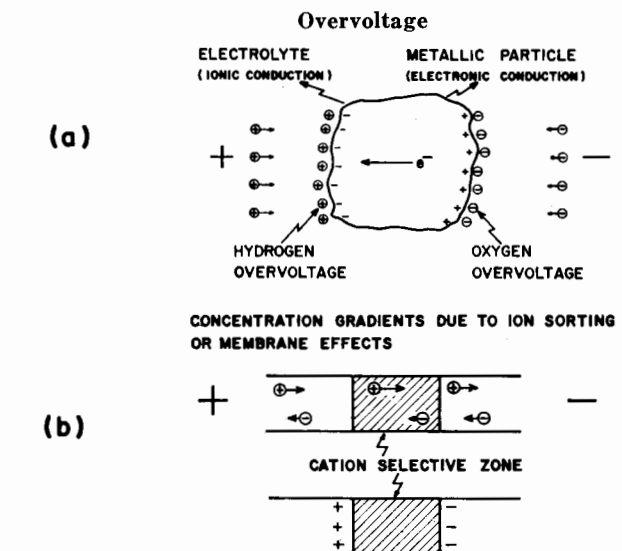

Figure 1.—Induced Polarization Agents.

to the electrochemists as "overvoltage." This is the phenomenon which can be utilized for the detection of the metallic conducting rock-forming minerals such as most sulphides, arsenides, a few oxides and, unfortunately, graphite. In addition, effective dipolar charge distributions occur to some extent in all rocks, due to ion-sorting or membrane effects in the fine capillaries in which the current is passing (Figure 1b). Induced polarization responses may therefore arise from metallic or non-metallic agencies. Fortunately, the latter generally fall within fairly low and narrow limits for almost all rock types, although there is still no reliable general criterion for differentiating overvoltage responses from graphite and metallic sulphides, or for distinguishing between the responses of one type of sulphide and another. Despite these limitations, the induced polarization method has amply demonstrated its value in mineral exploration since its initial development as a useful exploration tool in 1948. (Wait *et al.*, 1953).**

**"Overvoltage Research and Geophysical Applications," *Pergamon Press*, 1959, edited by J. R. Wait.

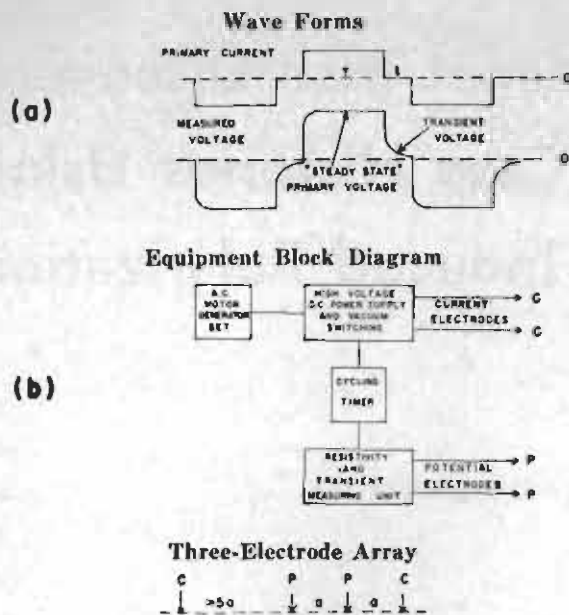

Figure 2.—The Pulse System.

Description of Method

For the present program, the pulse or time-domain system was employed. As shown on Figure 2a, the primary current wave form consists of square wave pulses of 1.5 seconds duration, separated by a 0.5-second gap and alternately reversed in direction. The polarization voltages established during the current-on time decay slowly during the current-off time. They are amplified, integrated over the current-off time and divided by the amplitude of the steady-state voltage measured during the current-on time. In this way, we determine the "chargeability;" i.e., the induced polarization property of the region under investigation. The units of chargeability are milliseconds. Normal (non-metallic) background chargeabilities in most rocks range from 1 millisecond to 5 milliseconds. A distribution of 1 per cent, by volume, of metallic conducting material of an average range of

particle size may be expected to increase the response level by about 3 milliseconds, which is readily visible.

The pulse system provides an absolute measurement of induced polarization; i.e., the significant measurement is made in the absence of the primary field. As such, it is inherently more sensitive than the frequency variation system, wherein two measurements are compared, both of which are made in the presence of the primary field. This is a critical consideration when mineralized bodies of low sulphide content, small size or great depth are being sought.

Figure 2b shows a block diagram of the apparatus employed and the electrode array used. The spacing "a" of the three-electrode array determines the effective depth of penetration of the survey and is selected to give adequate penetration to the depth desired. By varying the electrode spacing over an anomalous area and comparing the responses on the various spacings, one may obtain an estimate of the depth of burial of the source and its dip, etc.

A photograph of the type of apparatus employed on these surveys is shown in Figure 3. This is known as Seigel Mk V equipment and consists of the following major components: (a) a 1,200-watt A.C. motor-generator set, (b) a power control unit capable of supplying up to 1000 volts and 2 amperes D.C. output current and (c) a measuring unit. All of these items are packboard-mounted for maximum portability.

Figure 4 shows a typical instrumental set-up in Ireland. In the normal operating procedure, the electronic chassis are set up in a tent and cables are fed out to the line being surveyed. As the line crew is prepared, both mentally and by apparel, to work under all types of weather conditions, the survey is not stopped by rain, etc. This is important in Ireland, where, traditionally, there are no more than 60 rain-free days a year.

For the primary survey coverage on most properties, an electrode spacing of 200 to 300 ft. was generally employed, with a station interval of 200 ft. and a line separation of 300 to 500 ft. On anomalous areas located by the primary coverage, more closely spaced stations and lines are employed, as well as additional spacings to supply the detail necessary for subsequent drilling, etc.



Figure 3.—(above)—The Seigel Mk V Induced Polarization Unit.



Figure 4.—(right)—Typical Field Operational Base in Ireland.

Case Histories

In presenting the three case histories that follow, it must be made perfectly clear at the outset that these mineral discoveries are the product of teamwork, involving geological, geochemical and geophysical phases. It is on the basis of the first two phases that the areas for geophysical investigation have been selected. As the writer and his organization have been concerned only with the geophysical phase, this paper will, naturally, appear to emphasize it. The contribution of others to the broader exploration program must not be minimized, however.

In January, 1962, a large lead-zinc-silver deposit of a very unusual type was discovered near Tynagh, Co. Galway, in the Republic of Ireland. This deposit includes both a supergene enriched, partly oxidized upper zone and a sulphide primary zone and lies in dolomitic reef limestones of Carboniferous age near a fault contact with Devonian sandstones. Similar rock types and contacts occur in many parts of Ireland, so that an extensive program of exploration was initiated by a number of mining companies, starting in the summer of 1962. Although the pace has slowed up somewhat from the hectic days of 1962 and early 1963, this exploration program continues to the present time.

The usual exploration sequence, although not followed in detail by all companies, is as follows:

1

A selection of areas is made, based on the good government geological maps available. As nearly as possible, rock types and structures similar to those of the Tynagh deposit are sought. Those areas with known mineral showings are given high priority, of course.

2

The stream sediments in the drainage pattern are sampled and analyzed for significant amounts of copper, lead and zinc. Soil samples may also be taken, often on a regular grid basis, and analyzed. In this fashion, areas of abnormal metal content may be broadly defined. In detail, such geochemical sampling has often been hampered by man-made contamination and confused by soil transport by glacial, fluvial or human agencies.

3

Geophysical surveys, primarily the induced polarization type, are then conducted to map the subsurface distribution of sulphide mineralization and to provide guidance for a drilling program thereon.

This exploration program has already been remarkably successful, resulting, to date, in a new lead-zinc-silver mine-to-be at Silvermines, Co. Tipperary, for Consolidated Mogul Mines, Ltd., the probable copper-silver mine-to-be at Gortdrum, Cos. Tipperary and Limerick, for Gortdrum Mines, Ltd., and the interesting lead-zinc prospect at Keel, Co. Longford, for the Rio Tinto-Zinc group (Riofinex Ltd.). Figure 5 shows the location of the various recent mineral discoveries in Ireland. Despite a remarkable similarity in geological setting, the deposits are widely separated geographically, over a length of 80 miles, and no two are located on what can be called the same structure. This bodes well for the possibility of further discoveries being made in Ireland.

Each of the three case histories will be discussed below.

Silvermines Deposit

As the very name of the area implies, the Silvermines region had been known, for many centuries, as a locality mineralized with lead, zinc and silver. Metal production had taken place at several periods in the past, although at the time of the present investigations the mines were dormant. The very prominent Silvermines fault, striking about N 70°E, was known to be the significant control in the region, with the old mines and prospect pits scattered along its length over a distance of about 2 miles. Due to the past mining activity and transport by both drainage and man, a very extensive area gave rise to extremely high geochemical indications in lead and zinc. The induced polarization survey executed in late 1962 and early 1963 covered much of the concession area on 800-ft. sections and the geologically interesting portion thereof on 400-ft. sections. The three-electrode array, with 200-ft. electrode spacing, was employed on all lines, and spacings of 100 ft. and 400 ft. were also employed on the 400-ft. detail lines. In all, approximately 5 miles of the strike length of the Silvermines fault were covered by the present survey, 2½ miles in detail. At least ten distinct zones of abnormally high polarization were indicated, of which about half lay in the Silvermines mineralized belt and its extensions to the west and east.

One of these zones, designated the Garryard, has responded favourably to the subsequent drilling, resulting in the discovery of a mineable orebody.

To date, the announced proven tonnage figures include 12 million tons averaging approximately 8 per cent zinc, 3 per cent lead and 1 ounce of silver in the Garryard zone. This zone lies to the west of the zone from which the previous production had taken place.

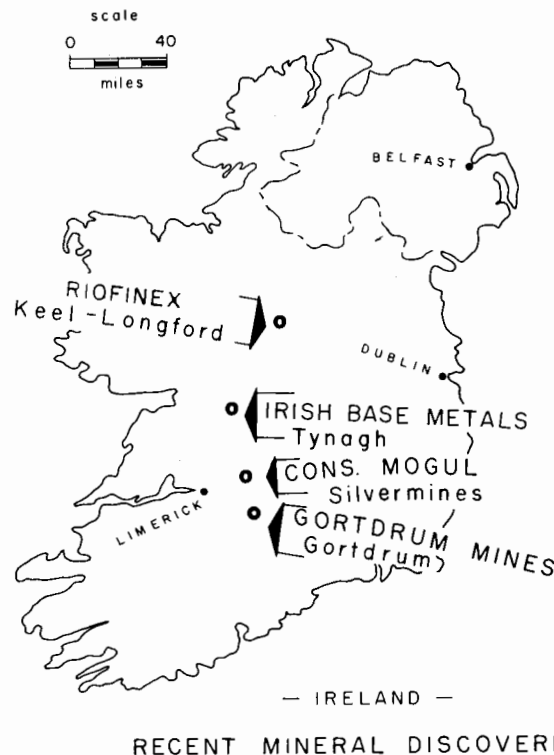

Figure 5.—Location Plan of Recent Mineral Discoveries in Ireland.

Figure 6 shows a typical discovery profile across the main ore zone, on the section 38,400E. The 200-ft. electrode spacing results, both chargeability and resistivity, are shown in profile form. The geologic section, as deduced from nine drill holes, is shown below the geophysical profiles. In a fashion almost identical

to that of the Tynagh deposit, the Silvermines ore-body is located in gently north-dipping dolomitic limestones adjacent to a fault contact with the Devonian "Old Red" sandstone. The mineralization here is composed of both massive and disseminated sulphides, with the former composed of a high percentage of pyrite. The mineralization is essentially conformable, in two distinct horizons, and is therefore flatly dipping except in the vicinity of the fault, where the dips are much steeper, perhaps due to "drag folding" on the fault.

Because of the high pyritic content of the mineralization near the fault, along which it comes closest to the ground surface, we see both a marked increase in chargeability and a sharp decrease in resistivity in that vicinity. From a normal background of 2-4 milliseconds, the chargeability curve rises to a peak response of 20 milliseconds over the sub-outcrop of the body on this section. The subsidiary peak of about 12 milliseconds near 11N is believed to be due to disseminated pyrite in the chert horizon.

Figure 7 shows the multiple spacing chargeability results on the same section, using electrode spacing of 100, 200 and 400 ft. and the three-electrode array. On comparing the results with the various spacings, two items of interest may be noted; firstly, the progressive increase in peak amplitude with spacing, testifying to the increase of mineralization with depth, even down to a depth of 300 ft., and, secondly, the presence of buried material of high polarization at depth beneath section 10N to 18N on this line. The latter is undoubtedly due to the down-dip extension of the upper mineralized horizon, which is present at depths of 300 to 400 ft. over this region.

The induced polarization results on the Silvermines deposit were quite definitive and have provided good guidance for the exploratory drilling. It is true, however, that the massive sulphide portions of this deposit would be amenable to detection by the more conventional electrical methods, such as electromagnetic induction or resistivity. As such, it is not as good a test of the capabilities of the induced polarization method as are the two case histories which follow.

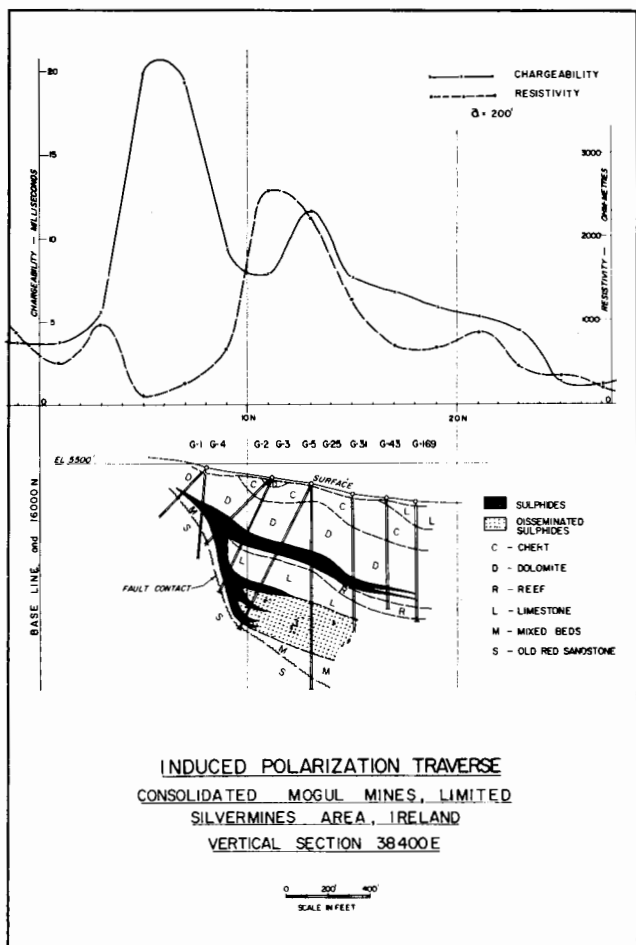

Figure 6.—Typical Discovery Traverse, Silvermines Deposit.

Gortdrum Deposit

The Gortdrum area, near the mutual border of Cos. Limerick and Tipperary, was originally selected to cover the eastern extension of the former Oola Mines lead-zinc deposit, some 3 miles to the west. Regional geochemical sampling of the stream sediments in this area, followed by soil traverses, indicated a moderately strong copper soil anomaly. Induced polarization surveys were carried out in May, 1963, and January, 1964, leading to the localization of the sulphide mineralization associated with the geochemical anomaly. As there was a 300-ft. lateral displacement between the centers of the geophysical and geochemical indications and the surface topography is very gentle, it was initially queried as to whether the two indications

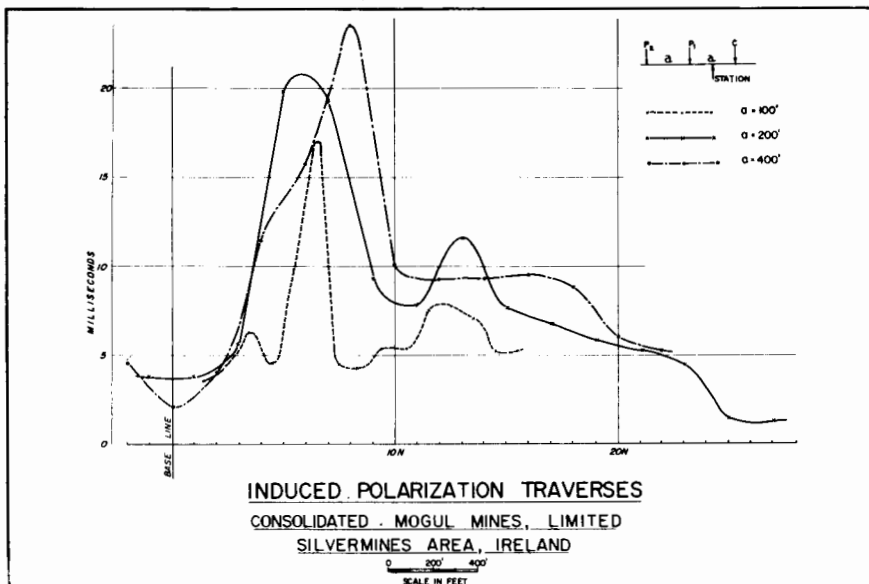

Figure 7.—Multiple Spacing Results, Silvermines Deposit.

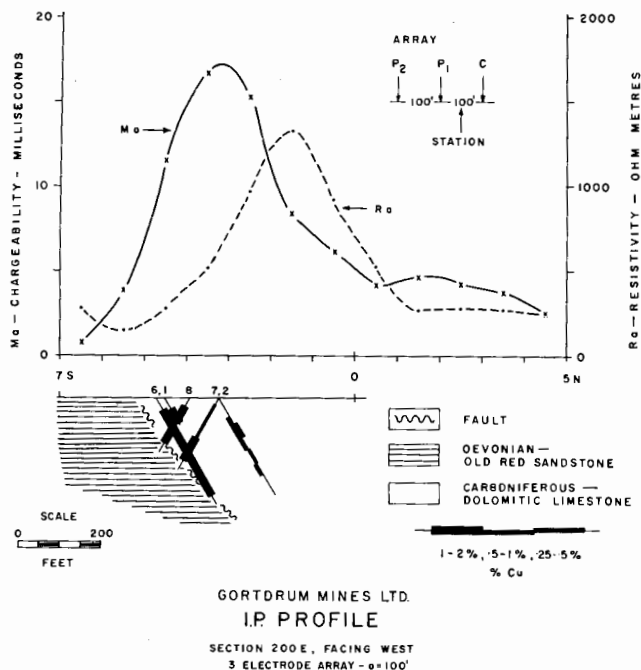

Figure 8.—Typical Discovery Traverse, Gortdrum Deposit.

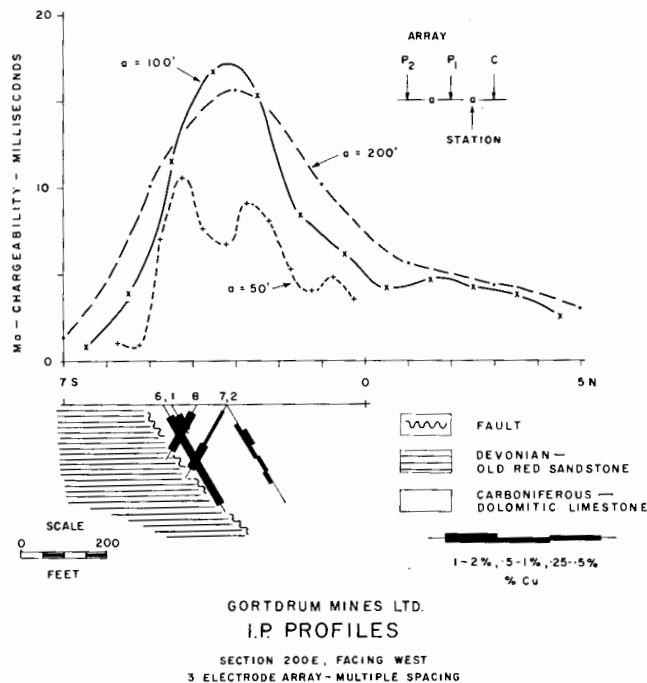

Figure 9.—Multiple Spacing Results, Gortdrum Deposit.

were related. The subsequent drilling has fully confirmed the geophysical predictions.

On the initial two geophysical programs, the three-electrode array with 100-ft. spacing was employed, as a relatively shallow source of the geochemical anomaly was expected. The survey lines were at 200-ft. intervals. Figure 8 presents a typical discovery traverse, showing both the chargeability and resistivity profiles as well as the corresponding geologic section. A peak chargeability of about 17 milliseconds is observed, rising from the normal background of 2-4 milliseconds. There is no resistivity expression of the mineralized zone, lying as it does on the flank of a high-resistivity area.

Figure 9 shows the chargeability profiles for electrode spacings of 50, 100 and 200 ft. Points of special interest deduced from these profiles include the following:

1.—The extremely sharp cut-off of the high chargeability levels on the south side of the area and the gradual drop-off in level on the north side. This was inconsistent with the thought of a bedded-type deposit conformable with the limestones, which are known to dip flatly to the south. A fault or other contact was postulated, dipping steeply, probably to the north. The initial drill holes on the section (Nos. 1, 2 and 6) were drilled to the north on the original geologic-dip premise, but the later holes (e.g., Nos. 7 and 8) have all been drilled to the south.

2.—The high-polarization material does not quite outcrop, but still comes within about 25 ft. of the ground surface across a width of about 200 ft., including two or more lenses. This material extends to at least 200 ft. in depth.

The actual drilling results confirm the presence of a zone of finely disseminated chalcocite and bornite, with very minor chalcopyrite, in dolomitic limestones. The mineralization is somewhat erratically distributed but, in general, increases as one approaches a north-

dipping fault, which brings the limestones into contact with the Devonian Old Red sandstones. This fault has been found to strike about N 70°E. Geologically, therefore, this environment is almost identical to that of the Tynagh and Silvermines deposits. The mineralization in the Gortdrum area is quite different, however, both in type and amount. The average grade of the deposit is less than 2 per cent copper, with about 0.65 ounce of silver for each 1 per cent copper (although considerable potential open-pit tonnage may exist), so that the average sulphide content, by volume, is 3 per cent or less. The high chargeability responses observed over this deposit are a remarkable tribute to the sensitivity of the pulse-type induced polarization method, particularly when dealing with truly disseminated-type sulphide mineralization with a small average particle size.

As development drilling is still in progress on this deposit, no over-all grade or tonnage figures have as yet been released.

Keel Deposit

The deposits near Keel and Longford, Co. Longford, occur on a known limestone-sandstone contact, which is, no doubt, one of the reasons why exploration interest was attracted thereto. Soil sampling traverses by Riofinex Ltd., an exploration subsidiary of Rio Tinto-Zinc Corporation, Ltd., established the presence of anomalous lead and zinc concentrations. A horizontal-loop electromagnetic survey was initially executed in another attempt to determine the source of the geochemical indications, but with negative results. This was followed by induced polarization surveys in November and December, 1962. The three-electrode array, with an electrode spacing of 200 ft., was employed on the reconnaissance survey. Anomalous chargeability zones were indicated and exploratory drilling commenced shortly thereafter. Although no publication of results has been made, they are of some potential interest, as drilling has continued, at intervals, to the present time.

Figure 10 shows a typical section across the prospect, presenting the geophysical and geochemical results in profile form, as well as the geological section interpreted from three holes. The relationship between the mineralized horizon, the geophysical peak and the geochemical peaks is a matter of considerable interest. The sub-outcrop of the mineralized horizon and the geophysical peak are in good agreement (see also Figure 11). The lead peak is displaced about 400 - 500 ft. down slope to the south. The zinc peak

is displaced still another 300 ft. to the south. The actual topographic slope is only 1-2 degrees to the south, so that this displacement is difficult to account for on the basis of soil creep. There is only a minor resistivity depression associated with the mineralization, indicating why the electromagnetic survey failed to give any positive response to it.

The mineralization itself is primarily sphalerite, with some galena and, on the average, less than 5 per cent pyrite. It is found to lie primarily in a dolomite horizon adjacent to a contact with sandstone. In this case, the contact may be largely a depositional one and not due to a fault. Mineralization occurs to a minor extent in the sandstone as well.

Figure 11 shows the chargeability results of the multiple spacing profiles on this section. Spacings of 50, 100 and 200 ft. were used. The progressive step-out of the peak values to the south with the increase in electrode spacing indicates the effect of the relatively flat dip to the south of the mineralization. The sub-outcrop of the mineralization is near station 26N, at a depth of less than 25 ft. As hole K3B, only 100 ft. away, intersected almost 60 ft. of overburden one must conclude that the bedrock surface is rather irregular in this area. The peak chargeability of 24 milliseconds would suggest a metallic conductor content of the order of 6 to 12 per cent, by volume, in this area.

It is the writer's hope that he has not given the impression that every induced polarization anomaly in Ireland inevitably defines an orebody, or that every exploration venture there is crowned with success. Aside from effects due to the many man-made conductors, such as grounded power lines, rabbit fences and buried pipe lines, there are certain carbonaceous sediments, in particular the Calp limestone, which overlies the ore-bearing dolomitic limestone in some places, which yield high polarization responses. Fortunately, the areal distribution of the latter is usually broad enough to suggest a formational origin. Also, fortunately, the Calp is, stratigraphically, sufficiently well separated from the ore-bearing limestones so that the effect from these two horizons may be resolved. With the geological and geochemical information available, one can usually determine whether a particular induced polarization indication warrants investigation by drilling. Despite its limitations, the pulse-type induced polarization method has well demonstrated its application to a broad range of base metal exploration problems in Ireland.

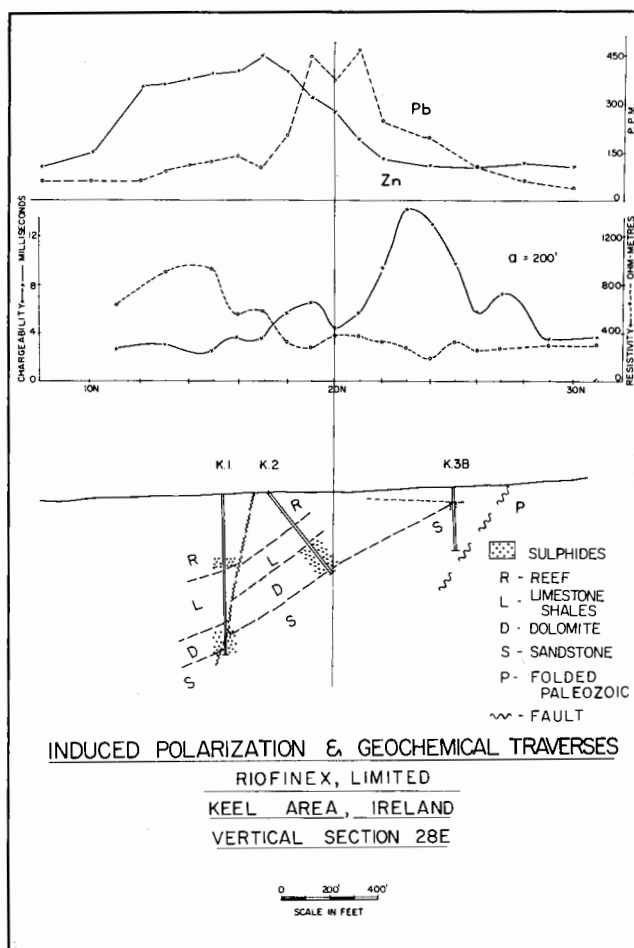

Figure 10.—Typical Discovery Traverse, Keel Deposit.

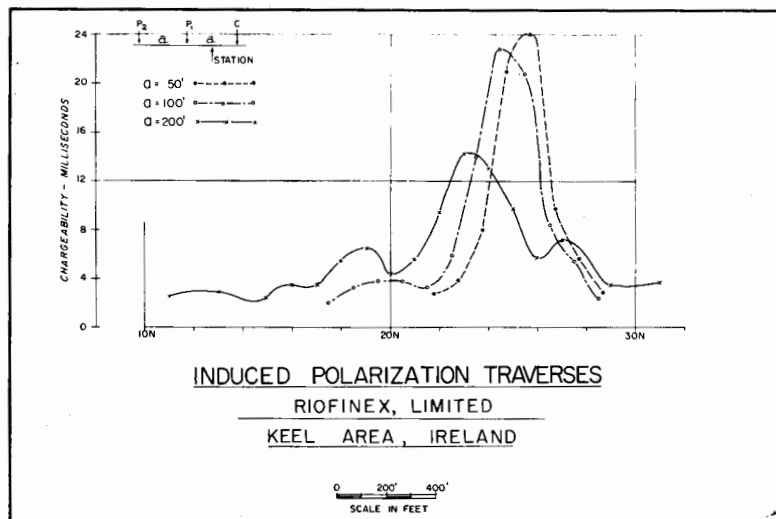

Figure 11.—Multiple Spacing Results, Keel Deposit.

Acknowledgments

The writer wishes to express his thanks to Consolidated Mogul Mines, Ltd., and Dr. W. W. Weber, to Gortdrum Mines, Ltd. and Dr. D. R. Derry, and to Rio Tinto-Zinc Corp. Ltd. and Mr. Jocelyn Pereira, for their kind permission to present the geophysical and other details relating to their respective mineral discoveries. In addition, the writer wishes to acknowledge the able assistance of the staff of Canadian Aero Mineral Surveys, Ltd., with which our company, Harold O. Seigel & Associates Ltd., has acted on a co-operative basis in Ireland.

(Reprinted from The Canadian Mining and Metallurgical Bulletin, November, 1965)

Printed in Canada

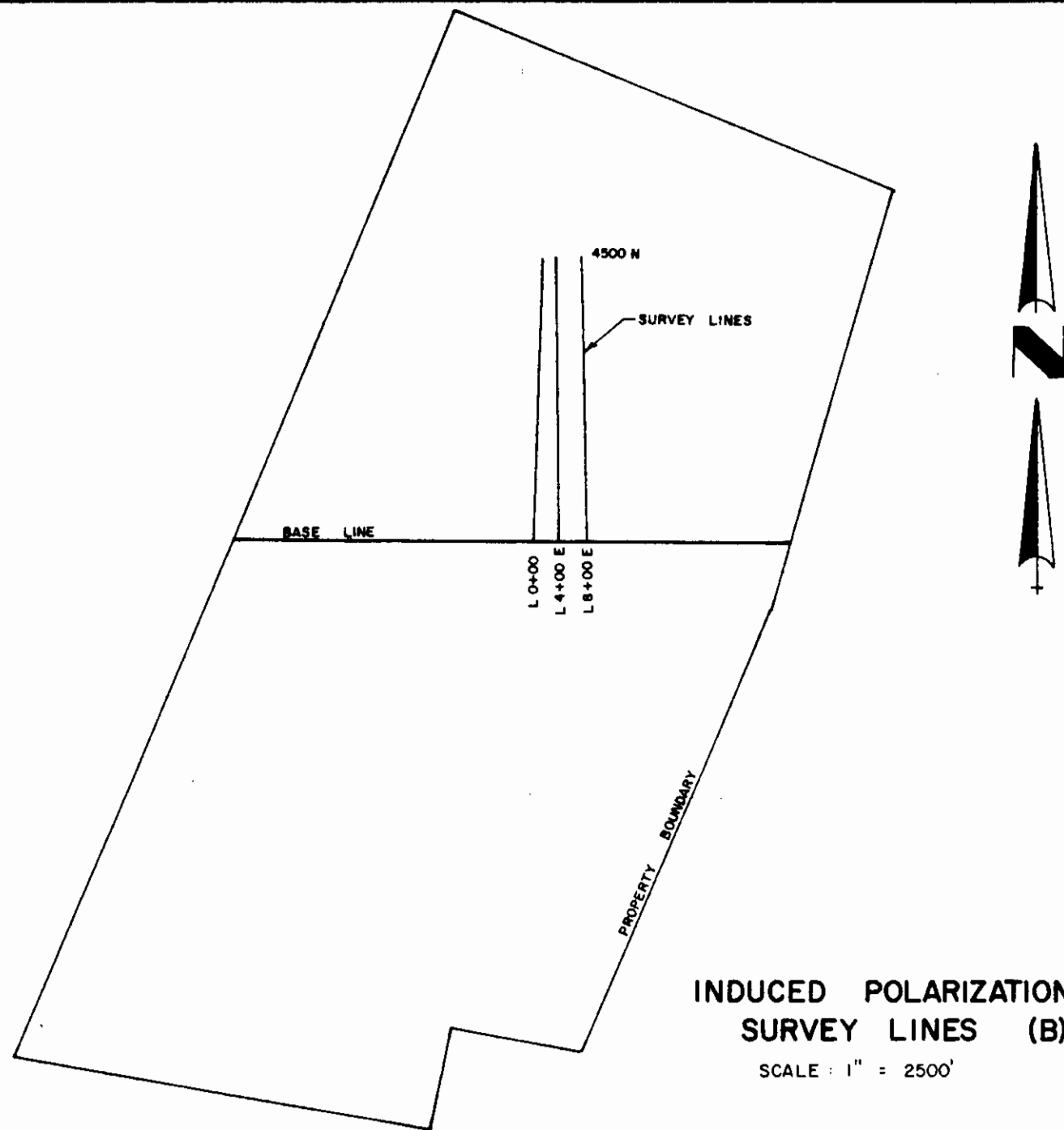

**INDUCED POLARIZATION
SURVEY LINES (B)**
SCALE : 1" = 2500'

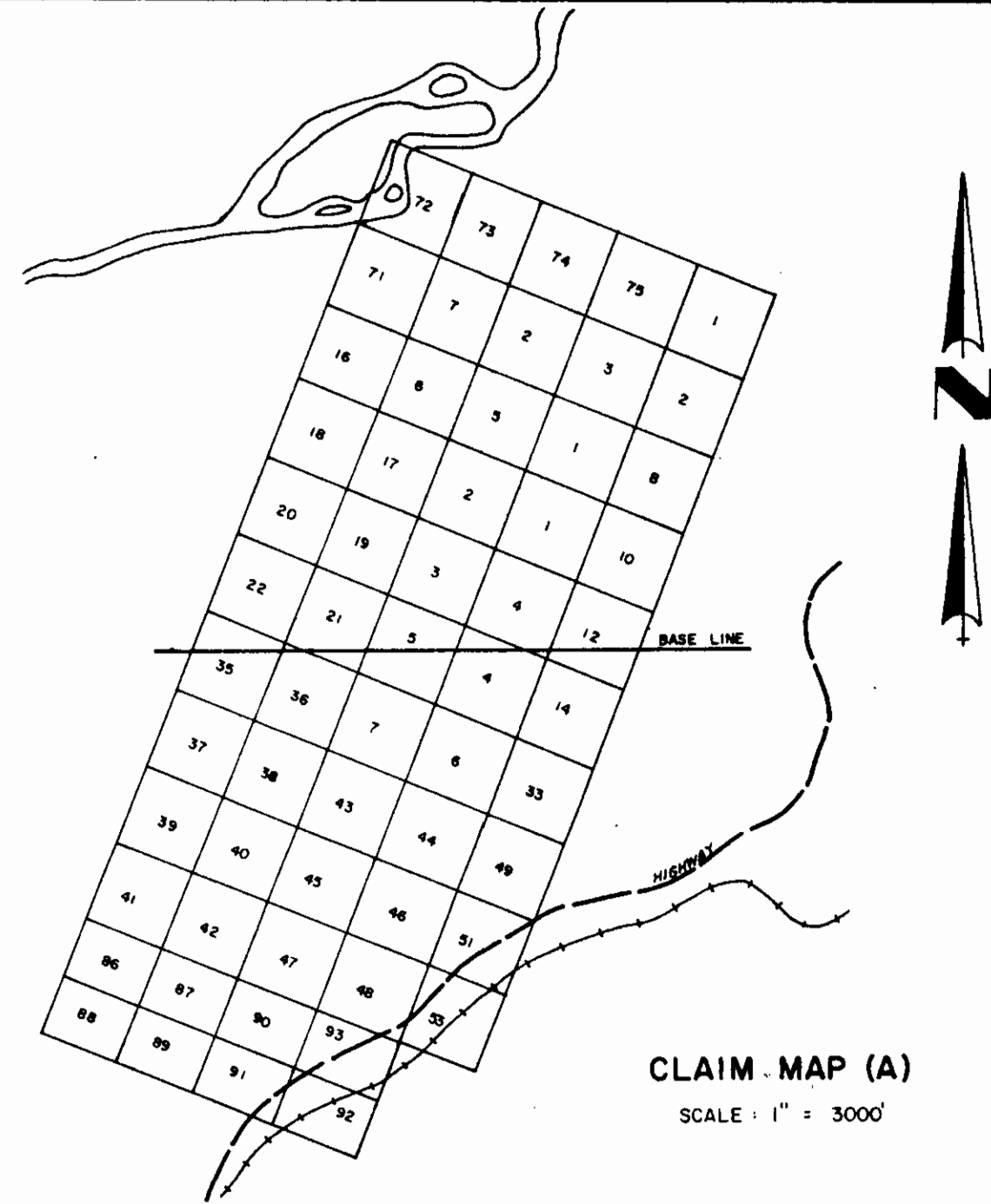

CLAIM MAP (A)
SCALE : 1" = 3000'

Department of
Mines and Petroleum Resources
ASSESSMENT REPORT
NO. 964 MAP 1

CINDY MINES LTD. (N.P.L.)
CRANBROOK PROPERTY
KOOTENAY DISTRICT, B.C.

SURVEYED BY:
SEIGEL ASSOCIATES LIMITED
MARCH, 1967

TO ACCOMPANY GEOPHYSICAL REPORT BY
RICHARD O. CROSBY P.ENG., DATED APRIL 12, 1967

964
PLATE 1

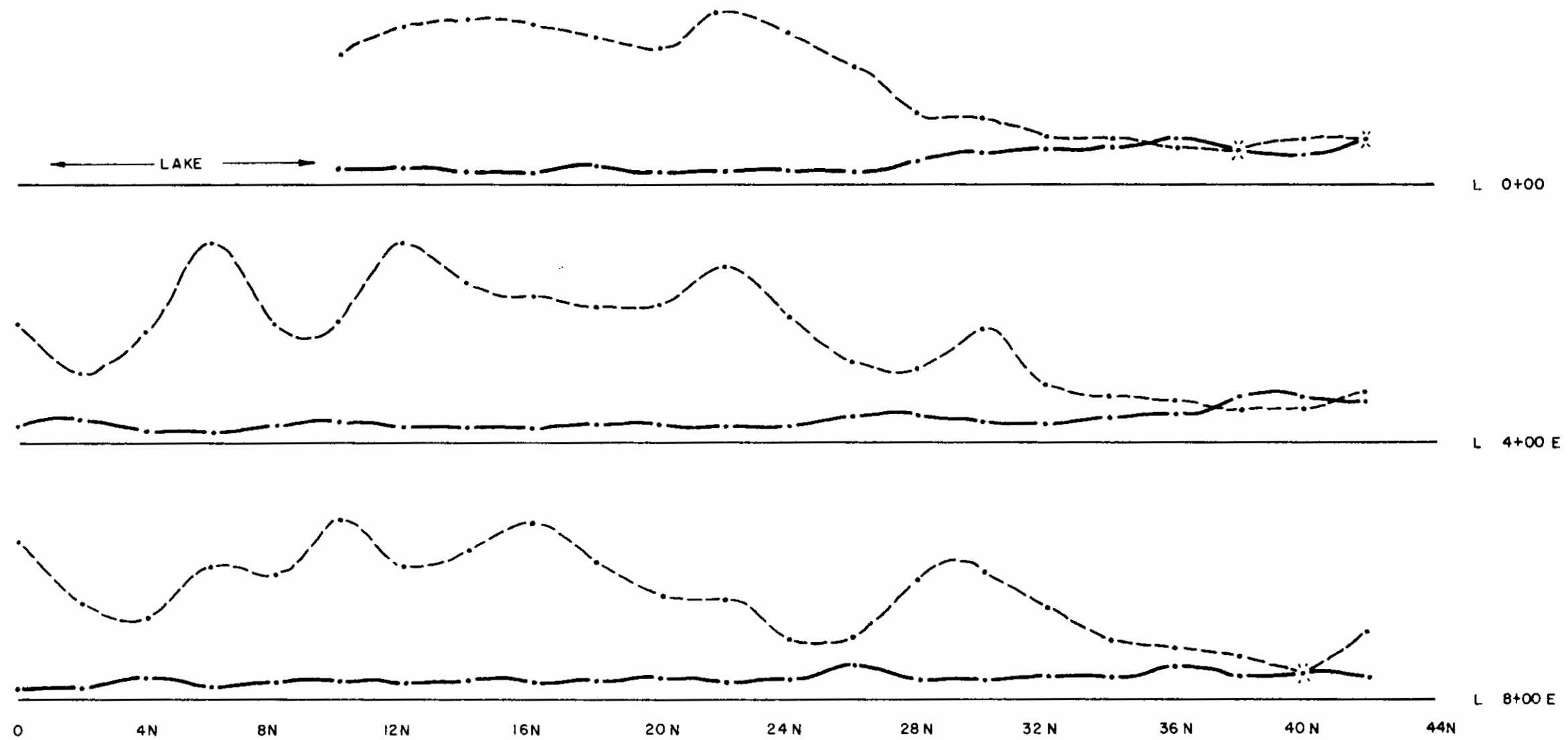

LEGEND

ELECTRODE SPACING : A = 400'

CHARGEABILITY : SCALE, 1" = 5 MILLISECONDS

RESISTIVITY : SCALE, 1" = 1000 OHM-METERS

INTERLINE SPACING, NOT TO SCALE

CINDY MINES LTD. (N.P.L.)

KOOTENAY DISTRICT, B.C.

INDUCED POLARIZATION SURVEY

SCALE : 1" = 400'

SURVEYED BY:

SEIGEL ASSOCIATES LIMITED

MARCH, 1967

TO ACCOMPANY GEOPHYSICAL REPORT BY
RICHARD O. CROSBY P.ENG., DATED APRIL 12, 1967

Department of
Mines and Petroleum Resources
ASSESSMENT REPORT
NO. 964 MAP 2

964
PLATE 2