

2012

REPORT ON
AN INDUCED POLARIZATION SURVEY
ON SOME BET AND JOE CLAIMS
HIGHLAND VALLEY AREA, BRITISH COLUMBIA
ON BEHALF OF
HIGHLAND VALLEY MINES LTD.

NO
92I/7W

92I07W

by

Jon G. Baird, B.Sc., P.Eng.

August 5, 1969

CLAIMS:

<u>Name</u>		<u>Record No.</u>
JOE	1 - 8	70925, 70932
BET	1 - 6	71732, 71737
BET	9 - 10	72065, 66
BET	11 - 12	

LOCATION:

About 20 miles NE of Spences Bridge, B.C.
Kamloops Mining Division
120° 50° SW

DATES:

May 22 - June 8, 1969

TABLE OF CONTENTS

	Page No.
SUMMARY	
INTRODUCTION	1
GEOLOGY	3
DISCUSSION OF RESULTS	4
CONCLUSIONS AND RECOMMENDATIONS	7
PLATES (in text)	
Plate 1 - Location Map	1" = 8 miles
(in envelope)	
Plate 2 - Claims Location and Grid Plan	1" = 1000'
Plate 3 - Chargeability Contours JOE 1 - 8 Claims	1" = 400'
Plate 4 - Resistivity Contours JOE 1 - 8 Claims	1" = 400'
Plate 5 - Chargeability Contours BET 9 - 12 Claims	1" = 400'
Plate 6 - Resistivity Contours BET 9 - 12 Claims	1" = 400'
Plate 7 - Chargeability Contours BET 1 - 6 and JOE 6 and 8 Claims	1" = 400'
Plate 8 - Resistivity Contours BET 1 - 6 and JOE 6 and 8 Claims	1" = 400'

5102
1" = 400'



Department of
Mines and Petroleum Resources
ASSESSMENT REPORT

NO. *2012* MAP

SUMMARY

The present induced polarization survey has revealed two areas of slightly above background chargeability responses.

Since very low concentrations of sulphide mineralization may be of economic significance, further investigation of these areas by geological, geochemical and/or geophysical methods may be warranted.



REPORT ON
AN INDUCED POLARIZATION SURVEY
ON SOME BET AND JOE CLAIMS
HIGHLAND VALLEY AREA, BRITISH COLUMBIA
ON BEHALF OF
HIGHLAND VALLEY MINES LTD.

INTRODUCTION

During the period from May 22 to June 8, 1969 a geophysical field party under the direction of Mr. Ulrich Kaltbrunner executed an induced polarization survey in the Highland Valley area, British Columbia, on behalf of Highland Valley Mines Ltd.

As shown on Plate 1, on the scale of 1" = 8 miles, the property lies approximately 20 miles NE of Spences Bridge. Plate 2, on the scale of 1" = 1000', shows that access to most of the survey grid is directly from the Highland Valley road. Access to the BET 9 - 12 claims was by an unimproved dirt road. The elevation of the survey area is about one mile above sea level and the terrain is rolling and treed, as is typical of the Highland Valley area.

The claims covered by the present survey are listed on the cover page of this report and are shown on Plate 2, on the scale of 1" = 1000'. The BET and JOE Claims are held by Highland Valley Mines Ltd.



Seigel Mk VI time domain (pulse-type) induced polarization equipment has been employed on this property. The transmitting unit had a rating of 2.5 kw and equal on and off times of 2.0 seconds. The receiving unit was a remote, ground-pulse type triggered by the rising and falling primary voltages set up in the ground by the transmitter. The integration of the transient polarization voltages takes place for 0.65 seconds after a 0.45 second delay time following the termination of the current-on pulse.

The purpose of an induced polarization survey is to map the subsurface distribution of metallically conducting mineralization which, on the present property could include bornite, chalcopryite, molybdenite, pyrite and other metallic sulphide minerals. As well, metallic conductors such as graphite and artificial installations such as pipelines, fences, etc., can give responses not always distinguishable from sulphide mineralization. These latter anomalous sources are not expected to occur on this property.

The accompanying copy of H. O. Seigel's paper entitled "Three Recent Irish Discovery Case Histories Using Pulse Type Induced Polarization" gives a description of the phenomena involved in this type of survey, the equipment employed, the field procedures and the nature of the results obtained over various base metal ore bodies.

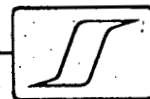

For the present survey base lines were laid out east-west on the JOE 1 - 8 and BET 1 - 6 claims and survey grid lines were established perpendicular thereto at 400' intervals. For the BET claims, the base line was oriented north-south and grid lines were laid out at 400' intervals in an east-west direction.

The three electrode array, with electrode spacings of 200' and 400', was employed for reconnaissance purposes. Station intervals were 200'.

GEOLOGY

A description of the geology of the area including and surrounding the present claims is found in GSC Memoir 262 "Ashcroft Map Area, British Columbia" by S. Duffell and K. C. McTaggart, 1952, and in GSC Memoir 249 "Nicola Map Area, British Columbia" by W. E. Cockfield, 1961. In addition, K. Northcote has mapped the geology of the Highland Valley area and one of his maps, on the scale of 1" = 1 mile, has been made available to the writer. Northcote shows the Guichon Creek Batholith as a series of differentiated granitic and granodioritic rocks, two of which phases may meet along a north-south contact lying within the present property.

The Highland Valley area, centred on the Guichon Creek Batholith, is well known for the occurrence of disseminated copper deposits. The main target of the present survey was one of these low grade, large tonnage deposits; the upper



surface of which would occur within 300' of the ground surface. A target of secondary interest would be a relatively narrow, steeply dipping zone of copper mineralization such as is presently being developed by Alwin Mines.

DISCUSSION OF RESULTS

JOE 1 - 8 Claims

The geophysical results for this survey grid are shown on a scale of 1" = 400' on Plates 3 and 4. Plate 3 shows chargeability contour plans for the 200' and 400' electrode spacings. The actual observed chargeability values are shown and areas exhibiting chargeabilities in excess of 6.0 milliseconds have been shaded. Plate 4 shows the resistivity results also in contour form. The contour interval is 25 ohm-metres and areas exhibiting resistivities in excess of 75 ohm-metres have been shaded.

Plate 3 reveals that the normal background chargeabilities are in the 2.0 to 5.0 millisecond range which is a normal non-metallic response range for the granitic rocks of the Guichon Batholith which are believed to underlie the present property. With this background a uniform distribution of 1% by volume of metallically conducting mineralization in the subsurface would be expected to add approximately 6.0 milliseconds to the background level. Chargeabilities in excess of about 6.0 milliseconds are considered worthy of further investigation since deposits of very low concentrations of



copper and molybdenum mineralization of sufficient dimensions may have economic significance.

Chargeability responses above 6.0 milliseconds in amplitude have been observed on parts of lines 56 W through 68 W for both the 200' and 400' electrode spacings. The highest single observation is a value of 8.8 milliseconds at station 9 S on L 56 W for the 200' electrode spacings.

Plate 4 reveals that approximately 50% of the survey area exhibits resistivities of less than 75 ohm-metres while the rest of the area has resistivities ranging up to about 300 ohm-metres. The areas of highest chargeability generally correspond with the areas of highest resistivity.

BET 9 - 12 Claims

Plate 5, on a scale of 1" = 400', shows chargeability contour plans for both electrode spacings. The contour interval is 2.0 milliseconds.

Plate 6, also on the scale of 1" = 400' is a resistivity contour plan contoured with a contour interval of 200 ohm-metres. Areas exhibiting resistivities in excess of 1000 ohm-metres have been shaded.

Plate 5 reveals that the chargeability values range from a low of 0.8 to a maximum observed value of 4.8 milliseconds. This range of chargeability values is very low and indicates that the material underlying the grid contains very little inherent metallically conducting mineralization.

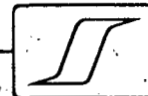

The resistivity contour plans on Plate 6 show that the resistivity values range from a few hundred to a maximum observed value of 4340 ohm-metres. About 60% of the survey area shows resistivities of less than 1000 ohm-metres while the remainder is above 1000 ohm-metre resistivity. The boundary between these two resistivity zones trends approximately northeasterly through the grid.

BET 1 - 6 and JOE 6 and 8 Claims

The geophysical results for these claims are shown on Plates 7 and 8 in similar form as for the previous grids.

The chargeability contour plan on Plate 7 reveals one area of increased chargeability response between lines 36 W and 52 W. The best supported zone of increased chargeabilities is for the 200' electrode separations where eight observations in excess of 6.0 and ranging up to 8.2 milliseconds have been taken. The highest chargeability observation however, is for the 400' electrode spacings and occurs at station 20 S on L 36 W. It is noted that the profile form for the 400' observations is considerably sharper than that for the 200' observations which is not a normal correlation. The possibility that the 10.5 millisecond observation may be spurious should therefore be considered.

The resistivity contours shown on Plate 8 reveal that much of the area of the survey grid exhibits resistivities ranging from 25 to 200 ohm-metres. Areas exceeding



200 ohm-metres have been shaded. The highest resistivity values ranging to above 1000 ohm-metres, occur at the extreme west end of the survey grid.

CONCLUSIONS AND RECOMMENDATIONS

An excellent correlation of chargeability and resistivity contour patterns is seen for each of the three survey grids. In general, areas of increased resistivity correspond to slight rises in the background chargeabilities. Experience in the Highland Valley area has shown that significant resistivity changes and moderate chargeability variations are usually due to changes in depth and thickness of overburden underlain by an undulating bedrock surface. For most parts of the Highland Valley area the bedrock resistivities are greater than the overburden resistivities. These observations would appear to be supported on the BET 9 - 12 claims where geological mapping by F. Lee of Western Geological Services indicates that the area of above 1000 ohm-metres resistivity responses corresponds to rock outcrops while lower resistivity values correspond to overburden covered areas.

The two areas of chargeability response in excess of 6.0 milliseconds correspond to zones of above background resistivities, however the normal case of less resistive overburden overlying more resistive bedrock may not occur. Examination of profiles for L 64 W of the BET 1 - 6 grid and

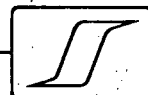

L 44 W of the JOE 1 - 8 grid indicates that there is a marked decrease in resistivity and a moderate decrease in peak chargeability when electrode spacings are increased from 200' to 400'. These responses are interpreted to indicate the occurrence of a relatively shallow zone of moderate chargeability and high resistivity whose depth extent is small compared to its near surface lateral extent. Such a zone could possibly occur within the overburden. Some detail traverses employing 100' and 50' electrode spacings would aid in making quantitative interpretations of the location, attitude and possible metallicly conducting content of the anomalous sources.

The present surveys have located two areas of chargeability amplitudes which for rocks of the Guichon Batholith may indicate low concentrations of sulphide mineralization. Since low grade deposits of copper and molybdenum mineralization of sufficient dimensions may have economic significance, the present areas should be subjected to further investigation. As well as the additional induced polarization surveying mentioned above, geological and geochemical studies of the increased chargeability zones should be carried out. If these investigations indicate that the present increased chargeabilities may indeed be due to concentrations of sulphide mineralization, then diamond drilling may be undertaken.

R. O. Crosby

R. O. Crosby, P. Eng.
Geophysicist

Vancouver, B.C.
August 5, 1969

Respectfully submitted,

SEIGEL ASSOCIATES LIMITED

Jon G. Baird

Jon G. Baird, B.Sc., P. Eng.
Geophysicist



DOMINION OF CANADA: }
PROVINCE OF BRITISH COLUMBIA. }
To Wit:

In the Matter of a geophysical survey on behalf of
Highland Valley Mines Ltd.

I, E. M. Flett for Seigel Associates Ltd.

of 750 - 890 West Pender St., Vancouver

in the Province of British Columbia, do solemnly declare that an induced polarization survey has been executed on some JOE and BET claims, Highland Valley area, British Columbia between May 22 to June 8, 1969. The following expenses were incurred:

(1) Wages:			
U. Kaltbrunner	18 days @ \$35.00/day	\$ 630.00	
M. Lengweiler	18		
R. Brocard	18		
D. Reid	18		
F. Butikofer	<u>18</u> 72 days @ \$27.50/day	<u>\$1,980.00</u>	\$2,610.00
(2) Transportation & Shipping to the job			83.35
(3) Transportation on the job			311.70
(4) Food & Living Expenses			934.23
(5) Use of geophysical equipment			
	18 days @ \$50.00/day		900.00
(6) Consulting Fees:			
	18 days @ \$412.26/day		<u>7,420.72</u>
			\$12,260.00

And I make this solemn declaration conscientiously believing it to be true; and knowing that it is of the same force and effect as if made under oath and by virtue of the "Canada Evidence Act."

Declared before me at the City
of Vancouver, in the
Province of British Columbia, this 18th
day of September, 1969, A.D.

E M Flett

Julie Turner
A Commissioner for taking Affidavits within British Columbia or
A Notary Public in and for the Province of British Columbia.
Sub-mining Recorder

In the Matter of

Statutory Declaration
(CANADA EVIDENCE ACT)



100-111-1111

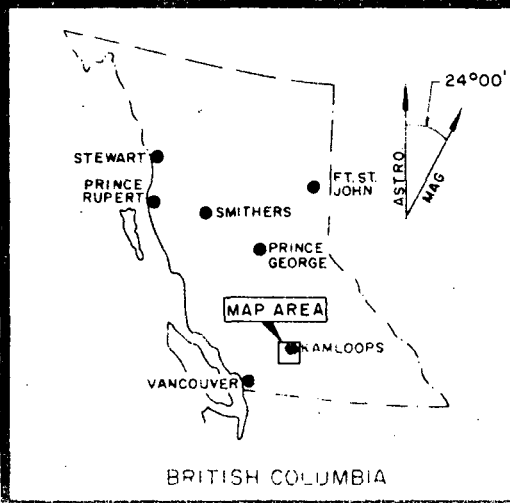
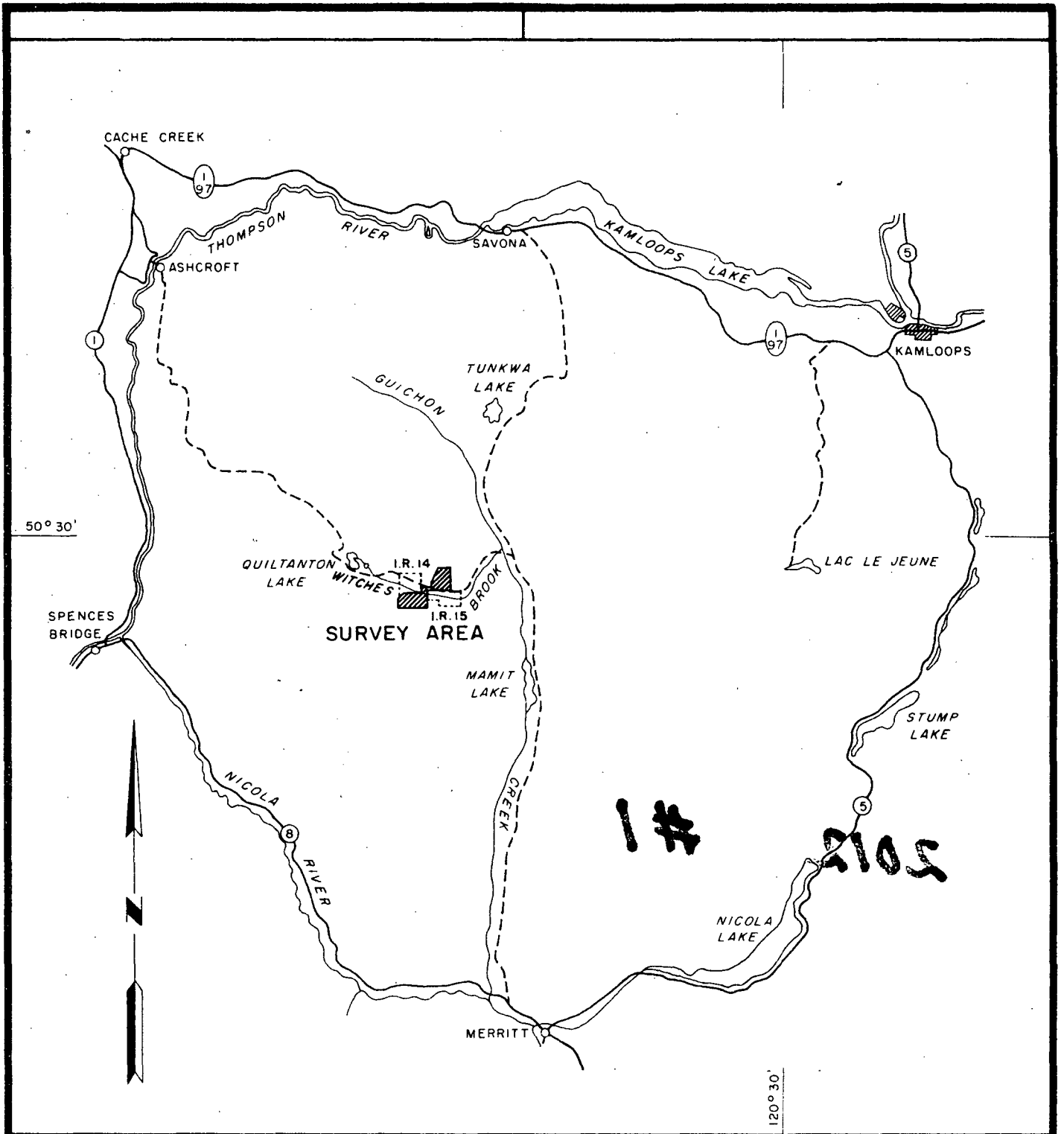

HIGHLAND VALLEY MINES LTD.

LOCATION MAP

BET AND JOE CLAIMS

HIGHLAND VALLEY AREA,

SCALE IN MILES

SURVEY BY SEIGEL ASSOCIATES LIMITED MAY 1969	PLATE 1
-----------------------------------------------------------	----------------

Department of
Mines and Petroleum Resources
ASSESSMENT REPORT

NO. 2012 MAP #1

Harold O. Seigel

President,
Harold O. Seigel & Assoc., Ltd.,
Downsview, Ontario

Annual General Meeting,
Toronto, March, 1965

Three Recent Irish Discovery Case Histories Using Pulse-Type Induced Polarization

Transactions, Volume LXVIII, 1965, pp. 343-348

ABSTRACT

In the intensive Irish exploration program which has followed the discovery of the Tynagh deposit (Northgate Exploration, Ltd.) in 1962, three base metal discoveries have been made to date. These include the lead-zinc-silver deposits at Silvermines (Consolidated Mogul Mines, Ltd.), which are now being readied for production, the copper-silver deposit at Gortdrum (Gortdrum Mines, Ltd.) and the lead-zinc deposits near Keel (Rio Tinto-Zinc Ltd.). Each of these discoveries is the result of a combined geological-geochemical-geophysical exploration sequence in which pulse-type induced polarization surveys defined the precise location and lateral extent of the near-surface metallic sulphide mineralization and guided the initial drilling program. Whereas the Silvermines mineralization is, in part, composed of massive sulphides, the other two deposits are characterized by generally less than 5 per cent conducting sulphides and constitute an excellent demonstration of the unique merits of the pulse-type induced polarization system.

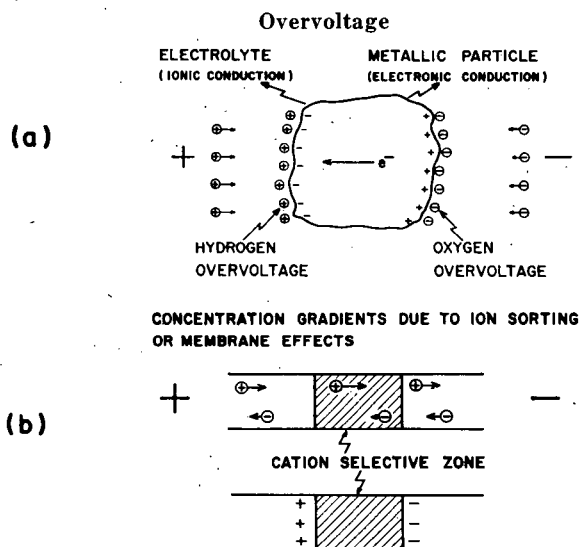

Figure 1.—Induced Polarization Agents.

Introduction

FOR the benefit of those who are unfamiliar with the induced polarization method in general or with the pulse-type method in particular, a few introductory remarks will be directed on the system employed in the present case histories. Those who wish a fuller treatment of the subject are directed to Seigel (1962),* which paper also includes an extensive list of references.

Induced polarization, in its broadest sense, means a separation of charge to form an effective dipolar (polarized) distribution of electrical charges throughout a medium under the action of an applied electric field. When current is caused to pass across the interface between an electrolyte and a metallic conducting body (Figure 1a) double layers of charge are built up at the interface, in the phenomenon known

to the electrochemists as "overvoltage." This is the phenomenon which can be utilized for the detection of the metallic conducting rock-forming minerals such as most sulphides, arsenides, a few oxides and, unfortunately, graphite. In addition, effective dipolar charge distributions occur to some extent in all rocks, due to ion-sorting or membrane effects in the fine capillaries in which the current is passing (Figure 1b). Induced polarization responses may therefore arise from metallic or non-metallic agencies. Fortunately, the latter generally fall within fairly low and narrow limits for almost all rock types, although there is still no reliable general criterion for differentiating overvoltage responses from graphite and metallic sulphides, or for distinguishing between the responses of one type of sulphide and another. Despite these limitations, the induced polarization method has amply demonstrated its value in mineral exploration since its initial development as a useful exploration tool in 1948. (Wait *et al.*, 1953).**

*Seigel, H. O., "Induced Polarization and its Role in Mineral Exploration," *C.I.M. Bulletin*, Vol. 55, No. 600, pp. 242-249; *Transactions*, Vol. LXV, pp. 151-158; 1962.

**"Overvoltage Research and Geophysical Applications," *Pergamon Press*, 1959, edited by J. R. Wait.

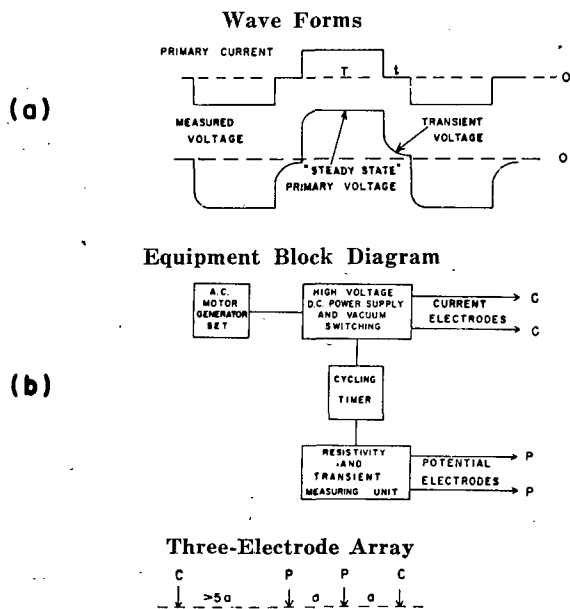

Figure 2.—The Pulse System.

Description of Method

For the present program, the pulse or time-domain system was employed. As shown on Figure 2a, the primary current wave form consists of square wave pulses of 1.5 seconds duration, separated by a 0.5-second gap and alternately reversed in direction. The polarization voltages established during the current-on time decay slowly during the current-off time. They are amplified, integrated over the current-off time and divided by the amplitude of the steady-state voltage measured during the current-on time. In this way, we determine the "chargeability;" i.e., the induced polarization property of the region under investigation. The units of chargeability are milliseconds. Normal (non-metallic) background chargeabilities in most rocks range from 1 millisecond to 5 milliseconds. A distribution of 1 per cent, by volume, of metallic conducting material of an average range of

particle size may be expected to increase the response level by about 3 milliseconds, which is readily visible.

The pulse system provides an absolute measurement of induced polarization; i.e., the significant measurement is made in the absence of the primary field. As such, it is inherently more sensitive than the frequency variation system, wherein two measurements are compared, both of which are made in the presence of the primary field. This is a critical consideration when mineralized bodies of low sulphide content, small size or great depth are being sought.

Figure 2b shows a block diagram of the apparatus employed and the electrode array used. The spacing "a" of the three-electrode array determines the effective depth of penetration of the survey and is selected to give adequate penetration to the depth desired. By varying the electrode spacing over an anomalous area and comparing the responses on the various spacings, one may obtain an estimate of the depth of burial of the source and its dip, etc.

A photograph of the type of apparatus employed on these surveys is shown in Figure 3. This is known as Seigel Mk V equipment and consists of the following major components: (a) a 1,200-watt A.C. motor-generator set, (b) a power control unit capable of supplying up to 1000 volts and 2 amperes D.C. output current and (c) a measuring unit. All of these items are packboard-mounted for maximum portability.

Figure 4 shows a typical instrumental set-up in Ireland. In the normal operating procedure, the electronic chassis are set up in a tent and cables are fed out to the line being surveyed. As the line crew is prepared, both mentally and by apparel, to work under all types of weather conditions, the survey is not stopped by rain, etc. This is important in Ireland, where, traditionally, there are no more than 60 rain-free days a year.

For the primary survey coverage on most properties, an electrode spacing of 200 to 300 ft. was generally employed, with a station interval of 200 ft. and a line separation of 300 to 500 ft. On anomalous areas located by the primary coverage, more closely spaced stations and lines are employed, as well as additional spacings to supply the detail necessary for subsequent drilling, etc.

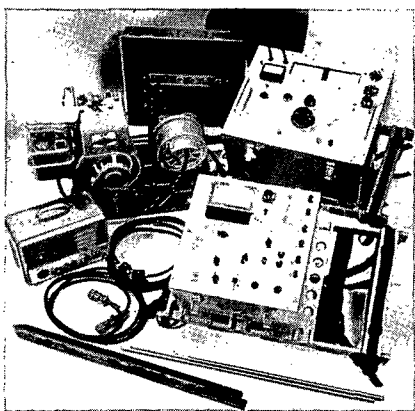

Figure 3.—(above)—The Seigel Mk V Induced Polarization Unit.



Figure 4.—(right)—Typical Field Operational Base in Ireland.

Case Histories

In presenting the three case histories that follow, it must be made perfectly clear at the outset that these mineral discoveries are the product of teamwork, involving geological, geochemical and geophysical phases. It is on the basis of the first two phases that the areas for geophysical investigation have been selected. As the writer and his organization have been concerned only with the geophysical phase, this paper will, naturally, appear to emphasize it. The contribution of others to the broader exploration program must not be minimized, however.

In January, 1962, a large lead-zinc-silver deposit of a very unusual type was discovered near Tynagh, Co. Galway, in the Republic of Ireland. This deposit includes both a supergene enriched, partly oxidized upper zone and a sulphide primary zone and lies in dolomitic reef limestones of Carboniferous age near a fault contact with Devonian sandstones. Similar rock types and contacts occur in many parts of Ireland, so that an extensive program of exploration was initiated by a number of mining companies, starting in the summer of 1962. Although the pace has slowed up somewhat from the hectic days of 1962 and early 1963, this exploration program continues to the present time.

The usual exploration sequence, although not followed in detail by all companies, is as follows:

1

A selection of areas is made, based on the good government geological maps available. As nearly as possible, rock types and structures similar to those of the Tynagh deposit are sought. Those areas with known mineral showings are given high priority, of course.

2

The stream sediments in the drainage pattern are sampled and analyzed for significant amounts of copper, lead and zinc. Soil samples may also be taken, often on a regular grid basis, and analyzed. In this fashion, areas of abnormal metal content may be broadly defined. In detail, such geochemical sampling has often been hampered by man-made contamination and confused by soil transport by glacial, fluvial or human agencies.

3

Geophysical surveys, primarily the induced polarization type, are then conducted to map the subsurface distribution of sulphide mineralization and to provide guidance for a drilling program thereon.

This exploration program has already been remarkably successful, resulting, to date, in a new lead-zinc-silver mine-to-be at Silvermines, Co. Tipperary, for Consolidated Mogul Mines, Ltd., the probable copper-silver mine-to-be at Gortdrum, Cos. Tipperary and Limerick, for Gortdrum Mines, Ltd., and the interesting lead-zinc prospect at Keel, Co. Longford, for the Rio Tinto-Zinc group (Riofinex Ltd.). Figure 5 shows the location of the various recent mineral discoveries in Ireland. Despite a remarkable similarity in geological setting, the deposits are widely separated geographically, over a length of 80 miles, and no two are located on what can be called the same structure. This bodes well for the possibility of further discoveries being made in Ireland.

Each of the three case histories will be discussed below.

Silvermines Deposit

As the very name of the area implies, the Silvermines region had been known, for many centuries, as a locality mineralized with lead, zinc and silver. Metal production had taken place at several periods in the past, although at the time of the present investigations the mines were dormant. The very prominent Silvermines fault, striking about N 70°E, was known to be the significant control in the region, with the old mines and prospect pits scattered along its length over a distance of about 2 miles. Due to the past mining activity and transport by both drainage and man, a very extensive area gave rise to extremely high geochemical indications in lead and zinc. The induced polarization survey executed in late 1962 and early 1963 covered much of the concession area on 800-ft. sections and the geologically interesting portion thereof on 400-ft. sections. The three-electrode array, with 200-ft. electrode spacing, was employed on all lines, and spacings of 100 ft. and 400 ft. were also employed on the 400-ft. detail lines. In all, approximately 5 miles of the strike length of the Silvermines fault were covered by the present survey, 2½ miles in detail. At least ten distinct zones of abnormally high polarization were indicated, of which about half lay in the Silvermines mineralized belt and its extensions to the west and east.

One of these zones, designated the Garryard, has responded favourably to the subsequent drilling, resulting in the discovery of a mineable orebody.

To date, the announced proven tonnage figures include 12 million tons averaging approximately 8 per cent zinc, 3 per cent lead and 1 ounce of silver in the Garryard zone. This zone lies to the west of the zone from which the previous production had taken place.

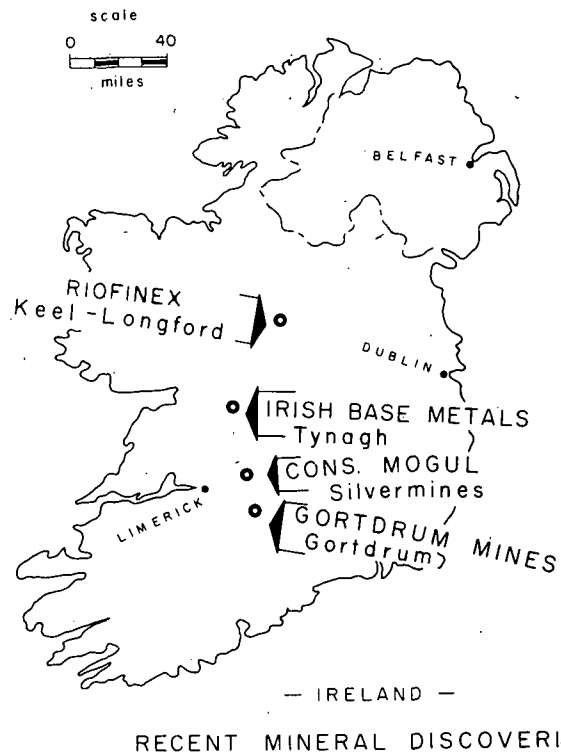

Figure 5.—Location Plan of Recent Mineral Discoveries in Ireland.

Figure 6 shows a typical discovery profile across the main ore zone, on the section 38,400E. The 200-ft. electrode spacing results, both chargeability and resistivity, are shown in profile form. The geologic section, as deduced from nine drill holes, is shown below the geophysical profiles. In a fashion almost identical

to that of the Tynagh deposit, the Silvermines ore-body is located in gently north-dipping dolomitic limestones adjacent to a fault contact with the Devonian "Old Red" sandstone. The mineralization here is composed of both massive and disseminated sulphides, with the former composed of a high percentage of pyrite. The mineralization is essentially conformable, in two distinct horizons, and is therefore flatly dipping except in the vicinity of the fault, where the dips are much steeper, perhaps due to "drag folding" on the fault.

Because of the high pyritic content of the mineralization near the fault, along which it comes closest to the ground surface, we see both a marked increase in chargeability and a sharp decrease in resistivity in that vicinity. From a normal background of 2-4 milliseconds, the chargeability curve rises to a peak response of 20 milliseconds over the sub-outcrop of the body on this section. The subsidiary peak of about 12 milliseconds near 11N is believed to be due to disseminated pyrite in the chert horizon.

Figure 7 shows the multiple spacing chargeability results on the same section, using electrode spacing of 100, 200 and 400 ft. and the three-electrode array. On comparing the results with the various spacings, two items of interest may be noted; firstly, the progressive increase in peak amplitude with spacing, testifying to the increase of mineralization with depth, even down to a depth of 300 ft., and, secondly, the presence of buried material of high polarization at depth beneath section 10N to 18N on this line. The latter is undoubtedly due to the down-dip extension of the upper mineralized horizon, which is present at depths of 300 to 400 ft. over this region.

The induced polarization results on the Silvermines deposit were quite definitive and have provided good guidance for the exploratory drilling. It is true, however, that the massive sulphide portions of this deposit would be amenable to detection by the more conventional electrical methods, such as electromagnetic induction or resistivity. As such, it is not as good a test of the capabilities of the induced polarization method as are the two case histories which follow.

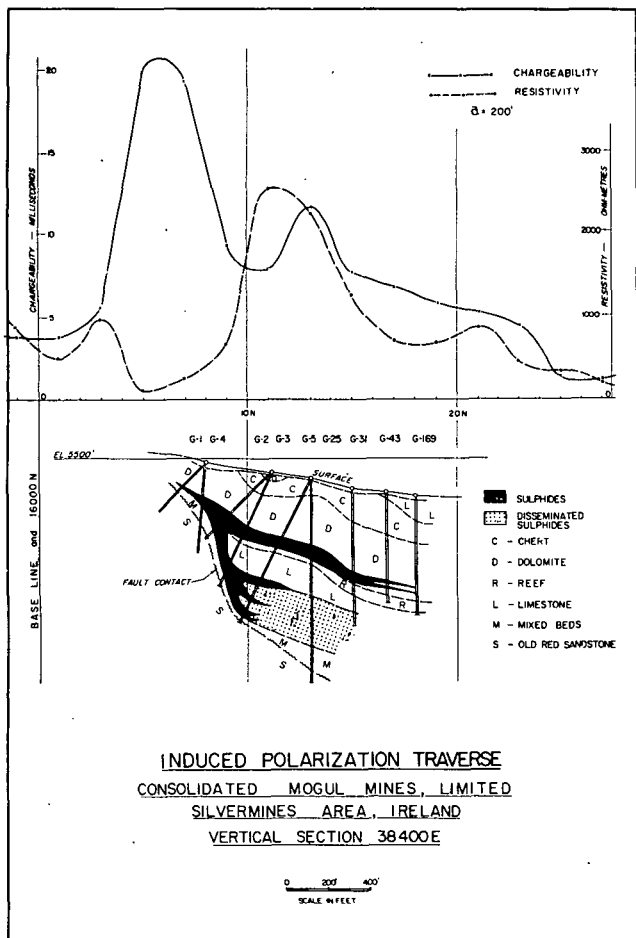

Figure 6.—Typical Discovery Traverse, Silvermines Deposit.

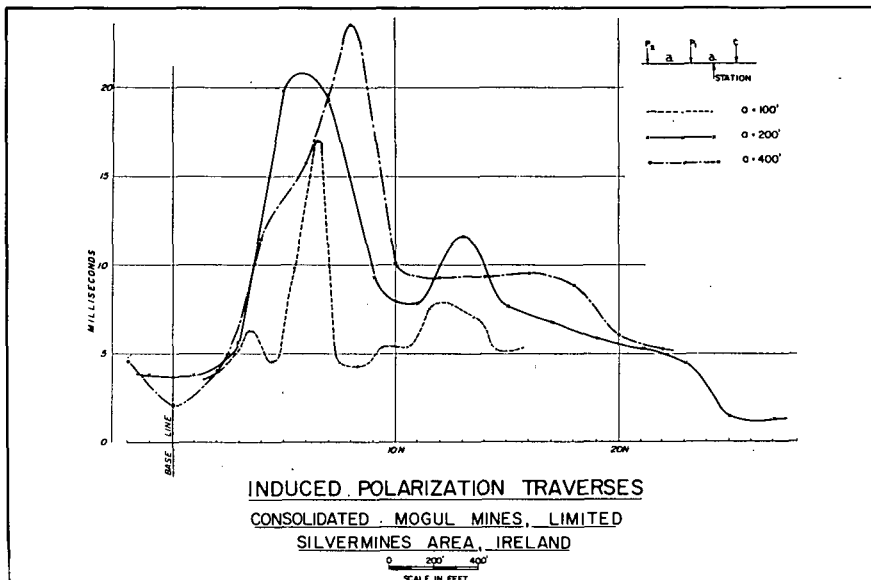

Figure 7.—Multiple Spacing Results, Silvermines Deposit.

Gortdrum Deposit

The Gortdrum area, near the mutual border of Cos. Limerick and Tipperary, was originally selected to cover the eastern extension of the former Oola Mines lead-zinc deposit, some 3 miles to the west. Regional geochemical sampling of the stream sediments in this area, followed by soil traverses, indicated a moderately strong copper soil anomaly. Induced polarization surveys were carried out in May, 1963, and January, 1964, leading to the localization of the sulphide mineralization associated with the geochemical anomaly. As there was a 300-ft. lateral displacement between the centers of the geophysical and geochemical indications and the surface topography is very gentle, it was initially queried as to whether the two indications

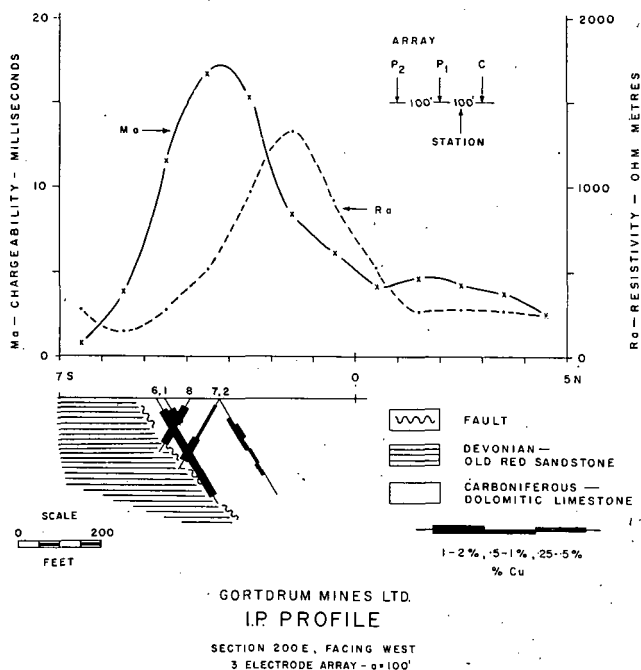

Figure 8.—Typical Discovery Traverse, Gortdrum Deposit.

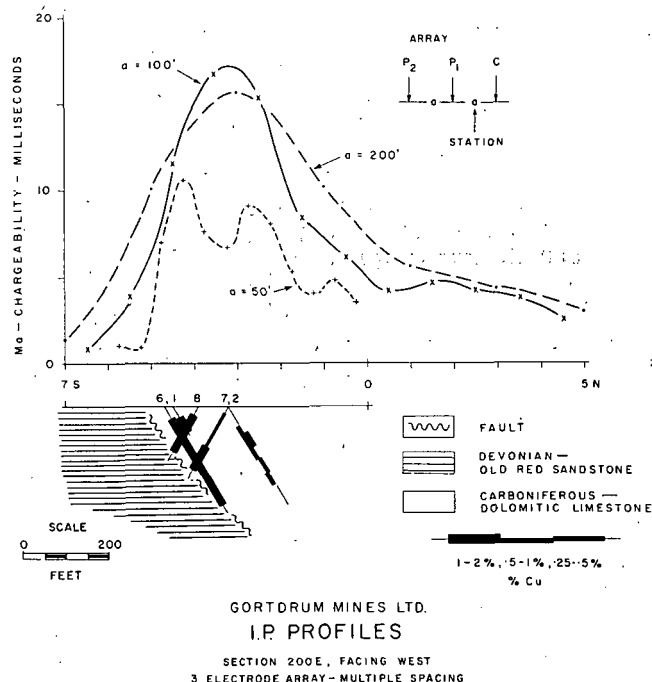

Figure 9.—Multiple Spacing Results, Gortdrum Deposit.

were related. The subsequent drilling has fully confirmed the geophysical predictions.

On the initial two geophysical programs, the three-electrode array with 100-ft. spacing was employed, as a relatively shallow source of the geochemical anomaly was expected. The survey lines were at 200-ft. intervals. Figure 8 presents a typical discovery traverse, showing both the chargeability and resistivity profiles as well as the corresponding geologic section. A peak chargeability of about 17 milliseconds is observed, rising from the normal background of 2-4 milliseconds. There is no resistivity expression of the mineralized zone, lying as it does on the flank of a high-resistivity area.

Figure 9 shows the chargeability profiles for electrode spacings of 50, 100 and 200 ft. Points of special interest deduced from these profiles include the following:

- 1.—The extremely sharp cut-off of the high chargeability levels on the south side of the area and the gradual drop-off in level on the north side. This was inconsistent with the thought of a bedded-type deposit conformable with the limestones, which are known to dip flatly to the south. A fault or other contact was postulated, dipping steeply, probably to the north. The initial drill holes on the section (Nos. 1, 2 and 6) were drilled to the north on the original geologic-dip premise, but the later holes (e.g., Nos. 7 and 8) have all been drilled to the south.

- 2.—The high-polarization material does not quite outcrop, but still comes within about 25 ft. of the ground surface across a width of about 200 ft., including two or more lenses. This material extends to at least 200 ft. in depth.

The actual drilling results confirm the presence of a zone of finely disseminated chalcocite and bornite, with very minor chalcopyrite, in dolomitic limestones. The mineralization is somewhat erratically distributed but, in general, increases as one approaches a north-

dipping fault, which brings the limestones into contact with the Devonian Old Red sandstones. This fault has been found to strike about N 70°E. Geologically, therefore, this environment is almost identical to that of the Tynagh and Silvermines deposits. The mineralization in the Gortdrum area is quite different, however, both in type and amount. The average grade of the deposit is less than 2 per cent copper, with about 0.65 ounce of silver for each 1 per cent copper (although considerable potential open-pit tonnage may exist), so that the average sulphide content, by volume, is 3 per cent or less. The high chargeability responses observed over this deposit are a remarkable tribute to the sensitivity of the pulse-type induced polarization method, particularly when dealing with truly disseminated-type sulphide mineralization with a small average particle size.

As development drilling is still in progress on this deposit, no over-all grade or tonnage figures have as yet been released.

Keel Deposit

The deposits near Keel and Longford, Co. Longford, occur on a known limestone-sandstone contact, which is, no doubt, one of the reasons why exploration interest was attracted thereto. Soil sampling traverses by Riofinex Ltd., an exploration subsidiary of Rio Tinto-Zinc Corporation, Ltd., established the presence of anomalous lead and zinc concentrations. A horizontal-loop electromagnetic survey was initially executed in another attempt to determine the source of the geochemical indications, but with negative results. This was followed by induced polarization surveys in November and December, 1962. The three-electrode array, with an electrode spacing of 200 ft., was employed on the reconnaissance survey. Anomalous chargeability zones were indicated and exploratory drilling commenced shortly thereafter. Although no publication of results has been made, they are of some potential interest, as drilling has continued, at intervals, to the present time.

Figure 10 shows a typical section across the prospect, presenting the geophysical and geochemical results in profile form, as well as the geological section interpreted from three holes. The relationship between the mineralized horizon, the geophysical peak and the geochemical peaks is a matter of considerable interest. The sub-outcrop of the mineralized horizon and the geophysical peak are in good agreement (see also Figure 11). The lead peak is displaced about 400 - 500 ft. down slope to the south. The zinc peak

is displaced still another 300 ft. to the south. The actual topographic slope is only 1-2 degrees to the south, so that this displacement is difficult to account for on the basis of soil creep. There is only a minor resistivity depression associated with the mineralization, indicating why the electromagnetic survey failed to give any positive response to it.

The mineralization itself is primarily sphalerite, with some galena and, on the average, less than 5 per cent pyrite. It is found to lie primarily in a dolomite horizon adjacent to a contact with sandstone. In this case, the contact may be largely a depositional one and not due to a fault. Mineralization occurs to a minor extent in the sandstone as well.

Figure 11 shows the chargeability results of the multiple spacing profiles on this section. Spacings of 50, 100 and 200 ft. were used. The progressive step-out of the peak values to the south with the increase in electrode spacing indicates the effect of the relatively flat dip to the south of the mineralization. The sub-outcrop of the mineralization is near station 26N, at a depth of less than 25 ft. As hole K3B, only 100 ft. away, intersected almost 60 ft. of overburden one must conclude that the bedrock surface is rather irregular in this area. The peak chargeability of 24 milliseonds would suggest a metallic conductor content of the order of 6 to 12 per cent, by volume, in this area.

It is the writer's hope that he has not given the impression that every induced polarization anomaly in Ireland inevitably defines an orebody, or that every exploration venture there is crowned with success. Aside from effects due to the many man-made conductors, such as grounded power lines, rabbit fences and buried pipe lines, there are certain carbonaceous sediments, in particular the Calp limestone, which overlies the ore-bearing dolomitic limestone in some places, which yield high polarization responses. Fortunately, the areal distribution of the latter is usually broad enough to suggest a formational origin. Also, fortunately, the Calp is, stratigraphically, sufficiently well separated from the ore-bearing limestones so that the effect from these two horizons may be resolved. With the geological and geochemical information available, one can usually determine whether a particular induced polarization indication warrants investigation by drilling. Despite its limitations, the pulse-type induced polarization method has well demonstrated its application to a broad range of base metal exploration problems in Ireland.

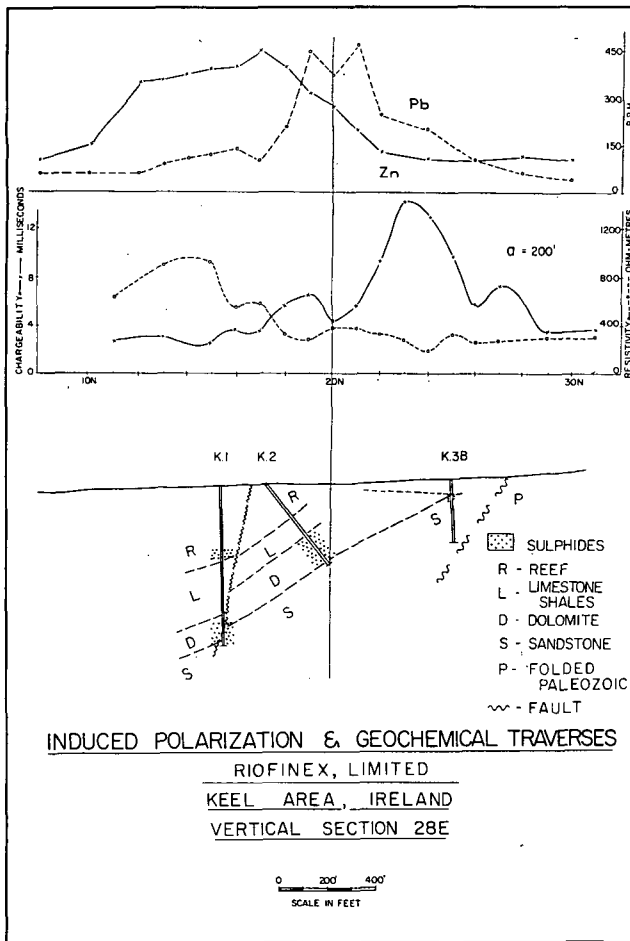

Figure 10.—Typical Discovery Traverse, Keel Deposit.

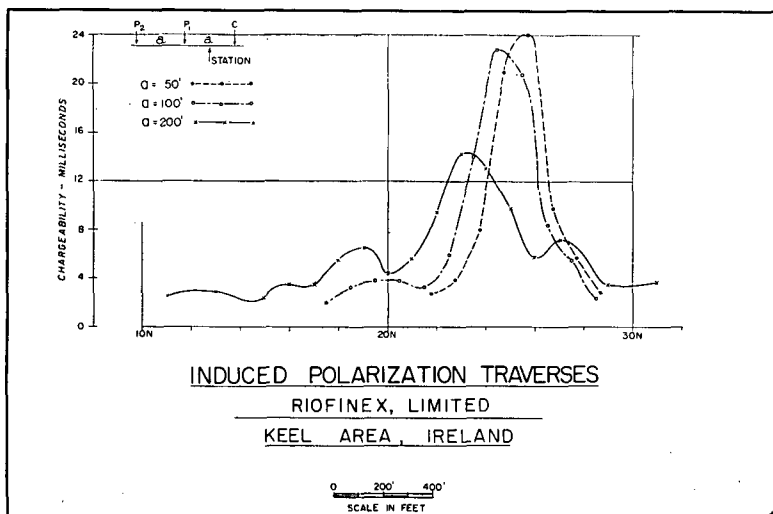

Figure 11.—Multiple Spacing Results, Keel Deposit.

Acknowledgments

The writer wishes to express his thanks to Consolidated Mogul Mines, Ltd., and Dr. W. W. Weber, to Gortdrum Mines, Ltd. and Dr. D. R. Derry, and to Rio Tinto-Zinc Corp. Ltd. and Mr. Jocelyn Pereira, for their kind permission to present the geophysical and other details relating to their respective mineral discoveries. In addition, the writer wishes to acknowledge the able assistance of the staff of Canadian Aero Mineral Surveys, Ltd., with which our company, Harold O. Seigel & Associates Ltd., has acted on a co-operative basis in Ireland.

(Reprinted from The Canadian Mining and Metallurgical Bulletin, November, 1965)

Printed in Canada

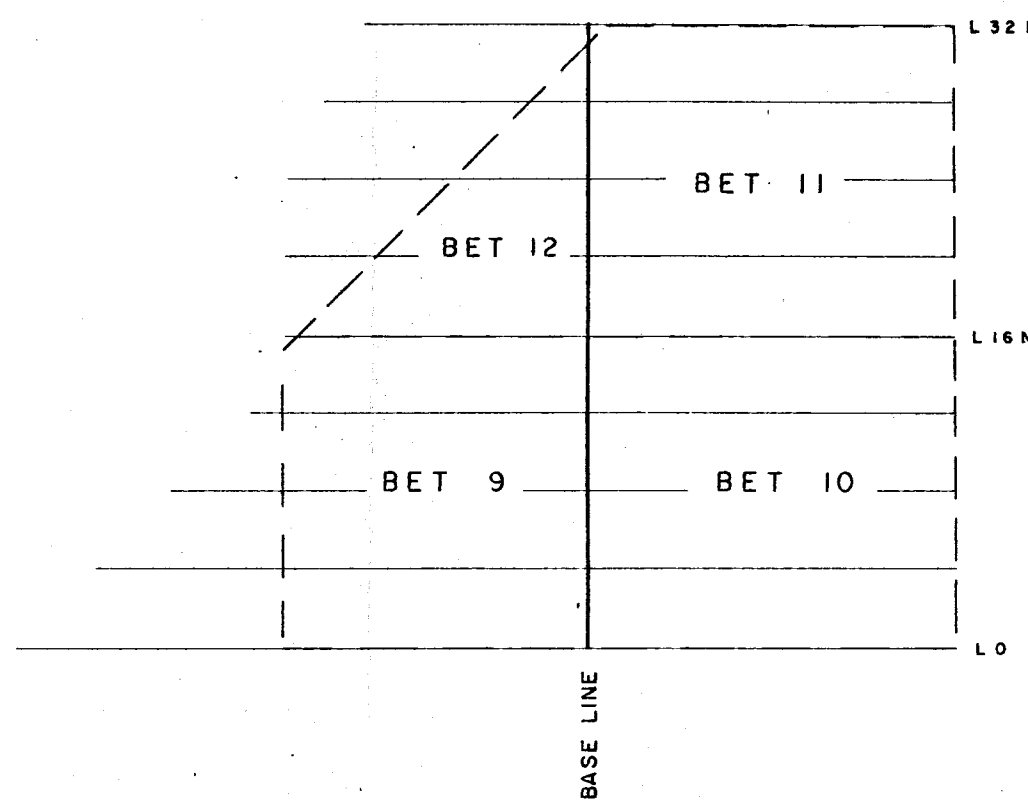
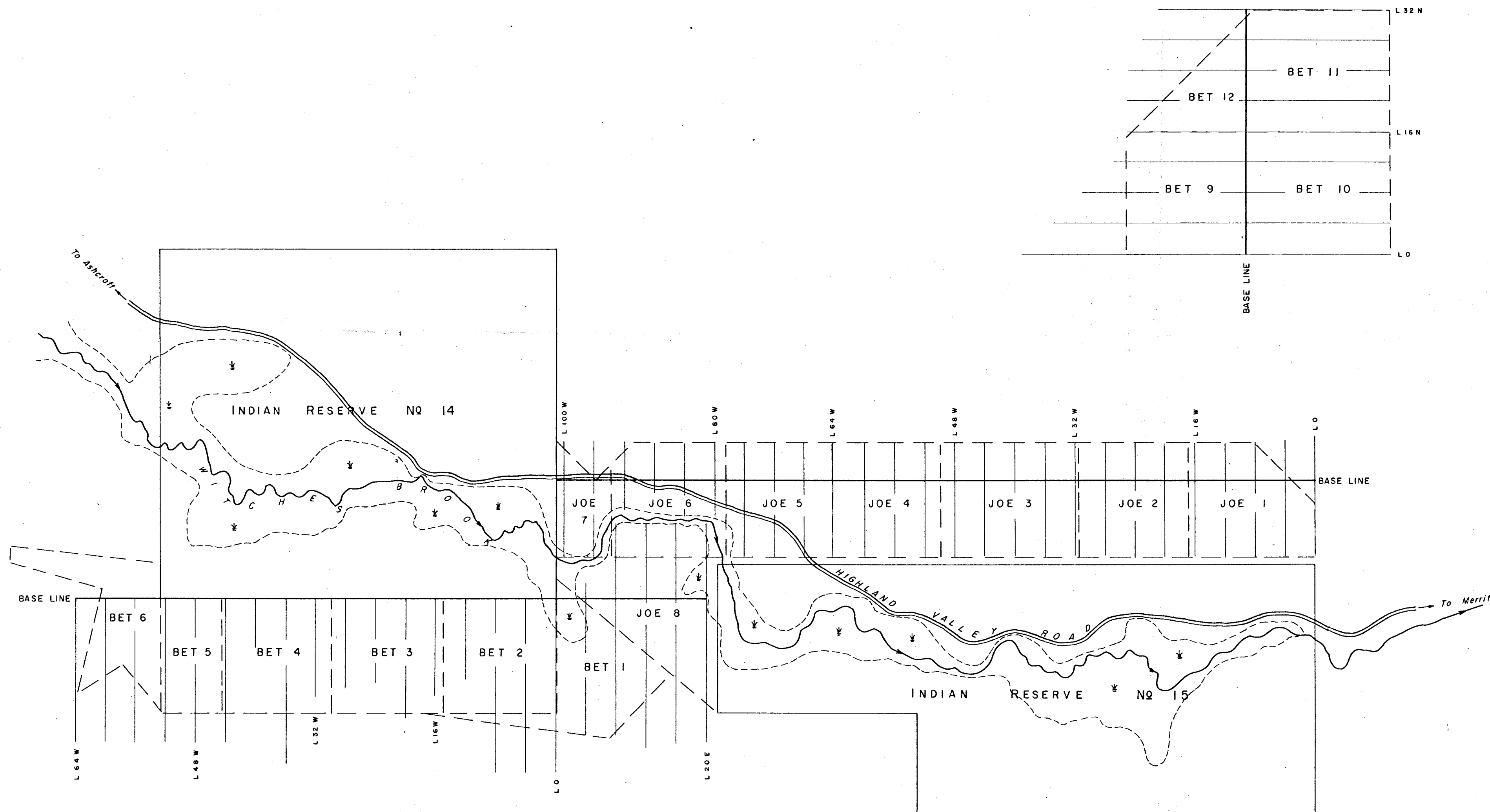
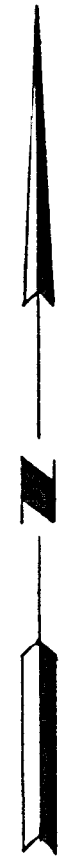

Department of
Mines and Petroleum Resources
ASSESSMENT REPORT
NO. 2012 MAP #2

PLATE 2
HIGHLAND VALLEY MINES LTD.
HIGHLAND VALLEY AREA, B.C.
CLAIMS LOCATION
AND
GRID PLAN
SCALE: 1" = 1000'

SURVEY BY SEIGEL ASSOCIATES LIMITED
MAY, 1969

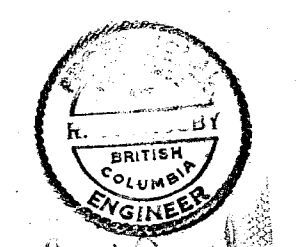

2012

TO ACCOMPANY A GEOPHYSICAL REPORT BY
J. G. BAIRD DATED AUGUST 5, 1969

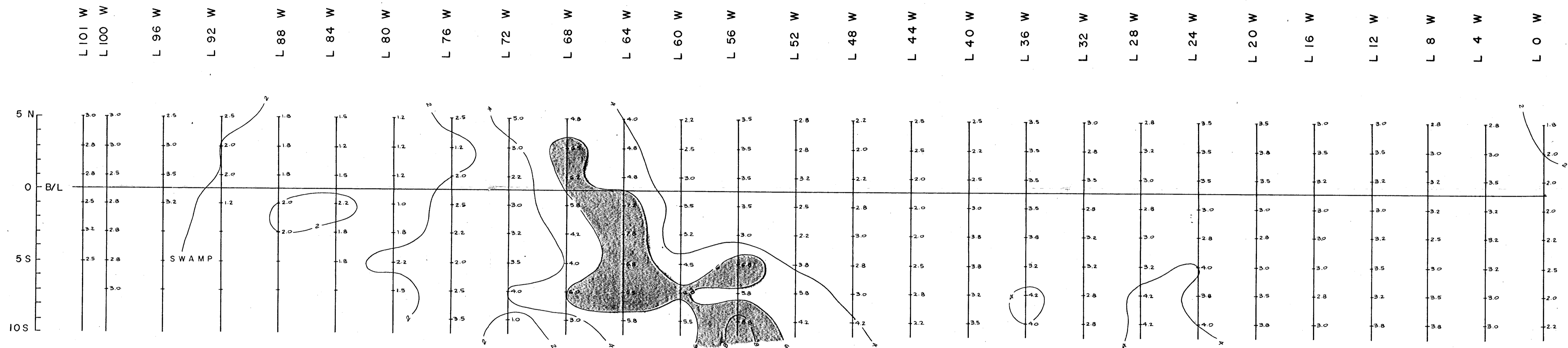

200 FOOT ELECTRODE SPACINGS

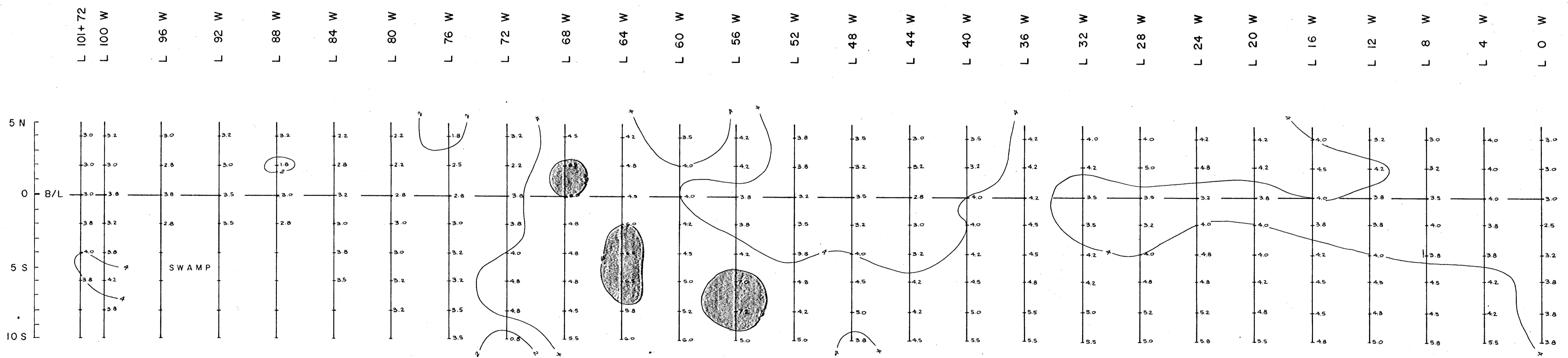

400 FOOT ELECTRODE SPACINGS

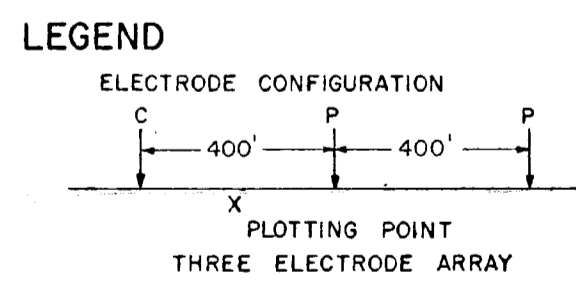

LINE TRACE WITH CHARGEABILITY VALUE IN MILLISECONDS
 CHARGEABILITY CONTOURS
 2 MILLISECOND CONTOUR INTERVAL

NOTES:
 SEIGEL MK.VI INDUCED POLARIZATION DATA



Department of
 Mines and Petroleum Resources
 ASSESSMENT REPORT
 NO. 1012 MAP. #3

PLATE 3
 HIGHLAND VALLEY MINES LTD.
 HIGHLAND VALLEY AREA B.C.
 JOE 1 TO 8 CLAIMS
 INDUCED POLARIZATION SURVEY
 CHARGEABILITY CONTOUR PLAN
 SCALE: 1" = 400'

SURVEY BY SEIGEL ASSOCIATES LIMITED
 MAY, 1969

TO ACCOMPANY A GEOPHYSICAL REPORT BY
 J. G. BAIRD DATED AUGUST 5, 1969

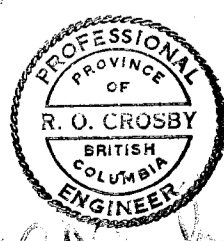

2012

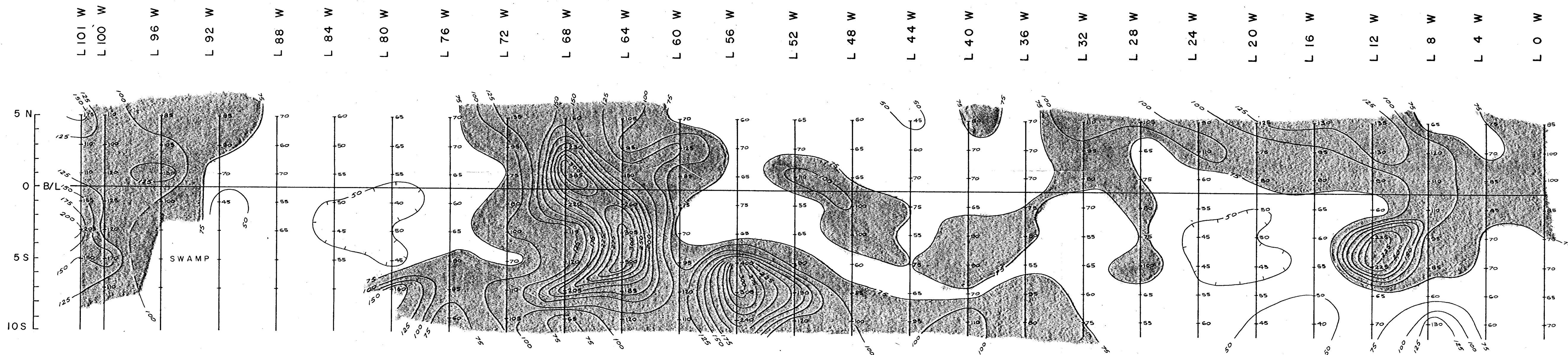

200 FOOT ELECTRODE SPACINGS

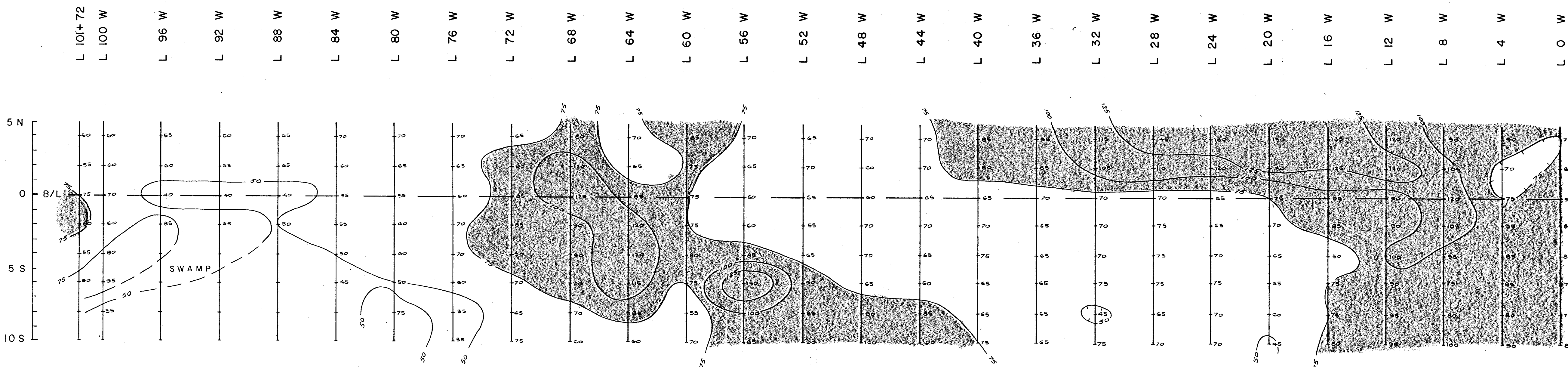

400 FOOT ELECTRODE SPACINGS

LEGEND

ELECTRODE CONFIGURATION

— 45 — LINE TRACE WITH RESISTIVITY VALUE IN OHM-METRES

— 25 — RESISTIVITY CONTOURS 25 OHM-METRE CONTOUR INTERVAL

Department of
Mines and Petroleum Resources
ASSESSMENT REPORT
NO. 2012 MAP #4

PLATE 4
HIGHLAND VALLEY MINES LTD.
HIGHLAND VALLEY AREA B.C.
JOE 1 TO 8 CLAIMS
INDUCED POLARIZATION SURVEY
RESISTIVITY CONTOUR PLAN
SCALE: 1" = 400'

SURVEY BY SEIGEL ASSOCIATES LIMITED
MAY 1969

TO ACCOMPANY A GEOPHYSICAL REPORT BY
J. G. BAIRD DATED AUGUST 5, 1969

2012

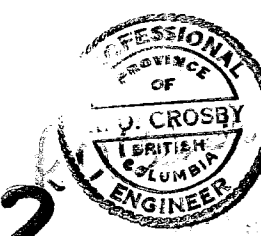

32 W 28 W 24 W 20 W 16 W 12 W 8 W 4 W 0 4 E 8 E 12 E 16 E 20 E

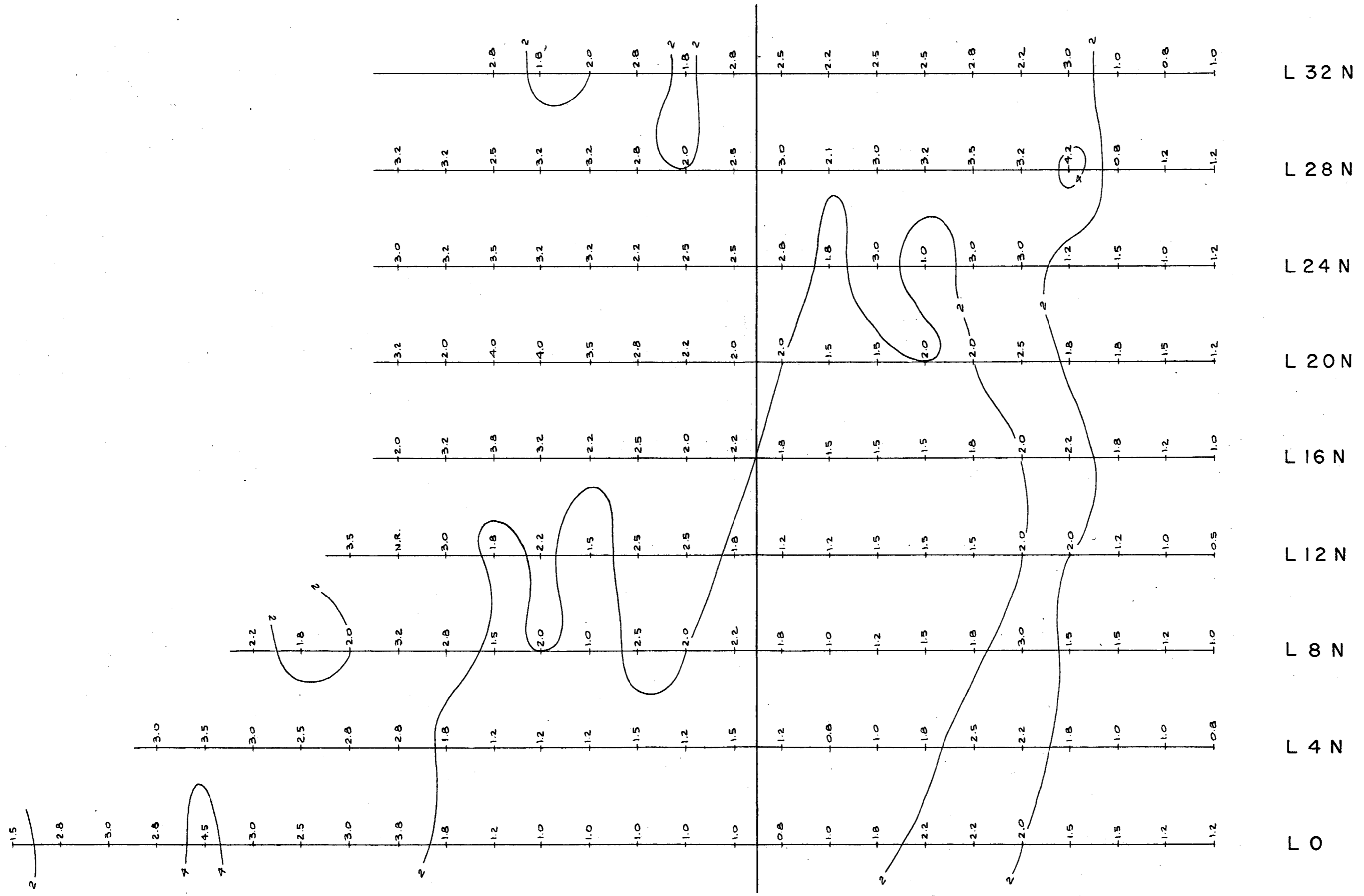

LEGEND
ELECTRODE CONFIGURATION
C 200' P 200' X
PLOTING POINT
THREE ELECTRODE ARRAY

200 FOOT ELECTRODE SPACINGS

32 W 28 W 24 W 20 W 16 W 12 W 8 W 4 W 0 4 E 8 E 12 E 16 E 20 E

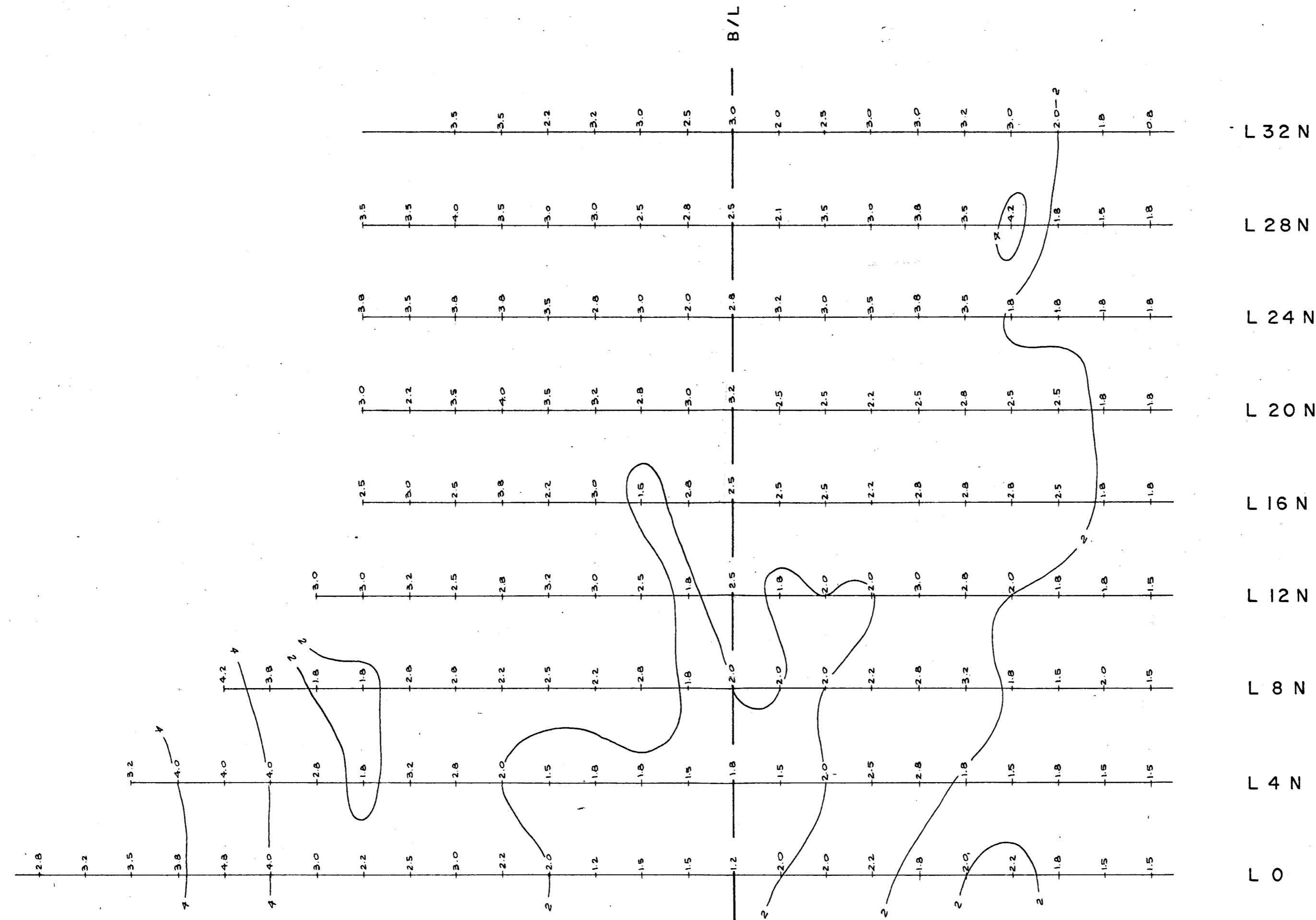

LEGEND
ELECTRODE CONFIGURATION
C 400' P 400' X
PLOTING POINT
THREE ELECTRODE ARRAY

— LINE TRACE WITH CHARGEABILITY VALUE IN MILLISECONDS
— CHARGEABILITY CONTOURS 2 MILLISECOND CONTOUR INTERVAL

Department of
Mines and Petroleum Resources
ASSESSMENT REPORT
NO. 2012 MAP #5

PLATE 5
HIGHLAND VALLEY MINES LTD.
HIGHLAND VALLEY AREA B.C.
BET 9 TO 12 CLAIMS
INDUCED POLARIZATION SURVEY
CHARGEABILITY CONTOUR PLAN
SCALE: 1" = 400'

SURVEY BY SEIGEL ASSOCIATES LIMITED
MAY, 1969



TO ACCOMPANY A GEOPHYSICAL REPORT BY
J.G. BAIRD DATED AUGUST 5, 1969

2012



32 W 28 W 24 W 20 W 16 W 12 W 8 W 4 W 0 4 E 8 E 12 E 16 E 20 E

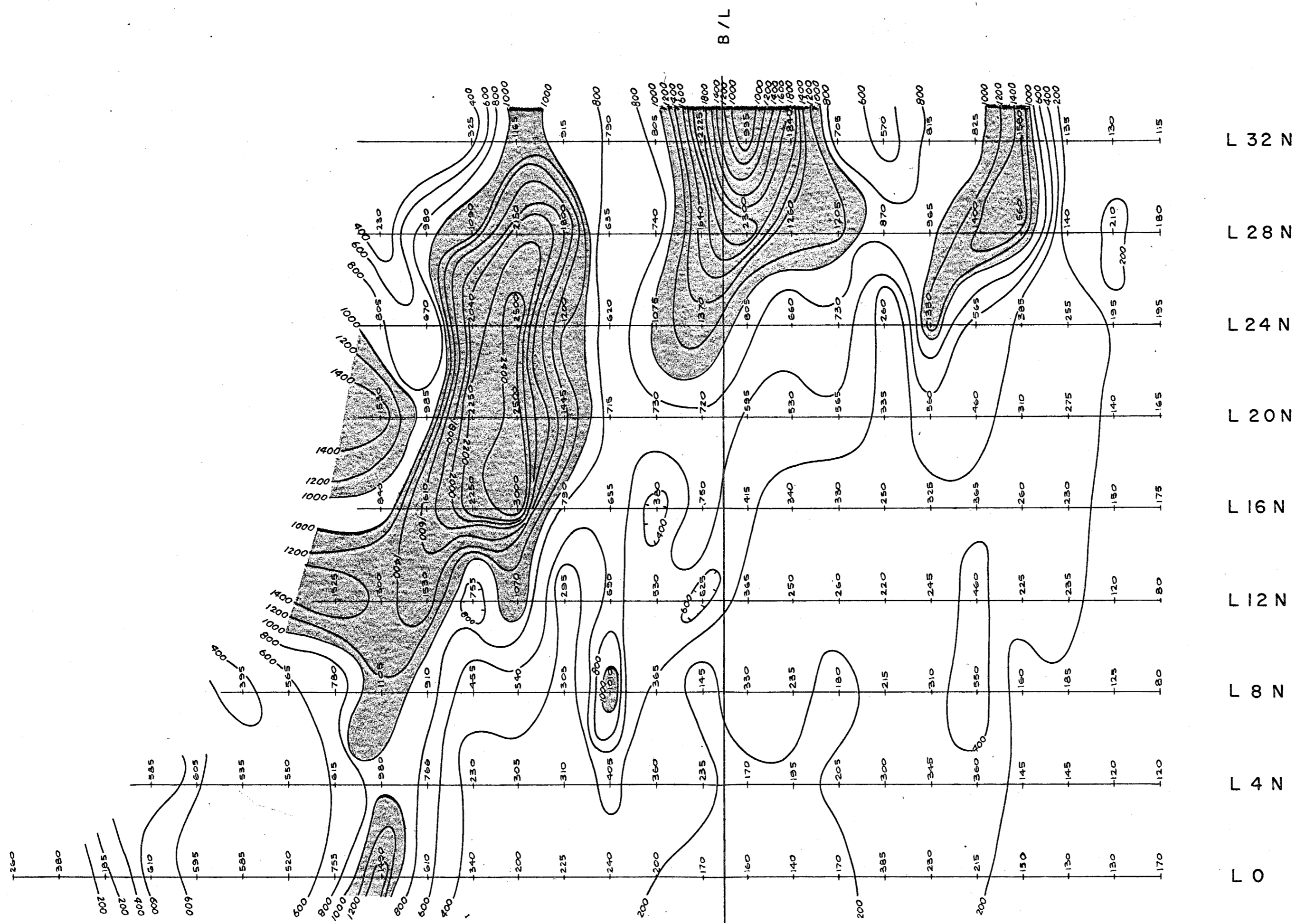

LEGEND
 ELECTRODE CONFIGURATION

 X PLOTTING POINT
 THREE ELECTRODE ARRAY

200 FOOT ELECTRODE SPACINGS



32 W 28 W 24 W 20 W 16 W 12 W 8 W 4 W 0 4 E 8 E 12 E 16 E 20 E

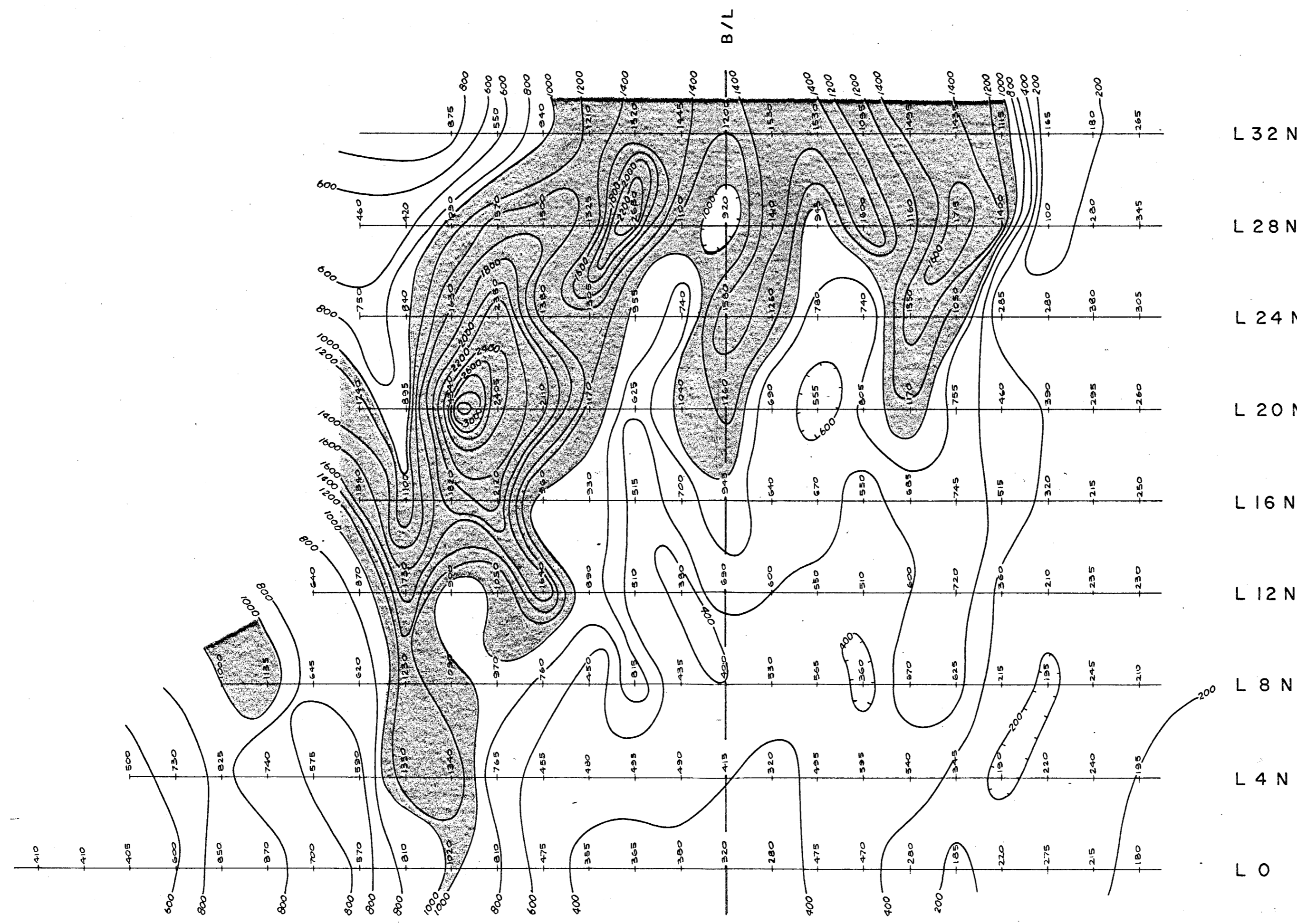

LEGEND
 ELECTRODE CONFIGURATION

 X PLOTTING POINT
 THREE ELECTRODE ARRAY

LINE TRACE WITH RESISTIVITY VALUE IN OHM-METRES
 RESISTIVITY CONTOURS
 200 OHM-METRE CONTOUR INTERVAL

400 FOOT- ELECTRODE SPACINGS

Department of
 Mines and Petroleum Resources
 ALBERTA
 NO. 2012 MAP #6

PLATE 6
 HIGHLAND VALLEY MINES LTD.
 HIGHLAND VALLEY AREA B.C.
 BET 9 TO 12 CLAIMS
 INDUCED POLARIZATION SURVEY
 RESISTIVITY CONTOUR PLAN
 SCALE: 1" = 400'

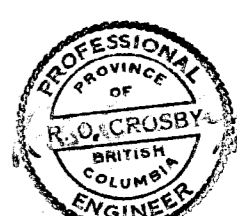

SURVEY BY SEIGEL ASSOCIATES LIMITED
 MAY, 1969

TO ACCOMPANY A GEOPHYSICAL REPORT BY
 J.G. BAIRD DATED AUGUST 5, 1969

2012

L 64 W L 60 W L 56 W L 52 W L 48 W L 44 W L 40 W L 36 W L 32 W L 28 W L 24 W L 20 W L 16 W L 12 W L 8 W L 4 W L 0 L 4 E L 8 E L 12 E L 16 E L 20 E

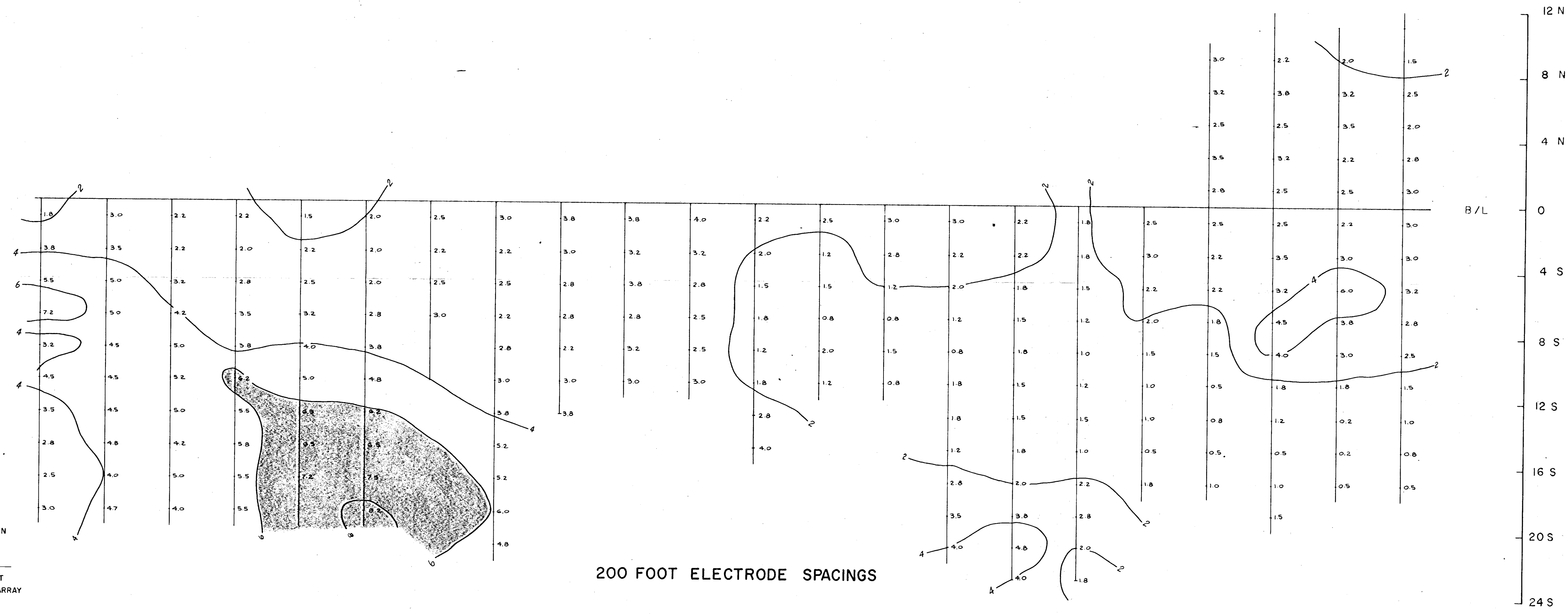

200 FOOT ELECTRODE SPACINGS

L 64 W L 60 W L 56 W L 52 W L 48 W L 44 W L 40 W L 36 W L 32 W L 28 W L 24 W L 20 W L 16 W L 12 W L 8 W L 4 W L 0 L 4 E L 8 E L 12 E L 16 E L 20 E

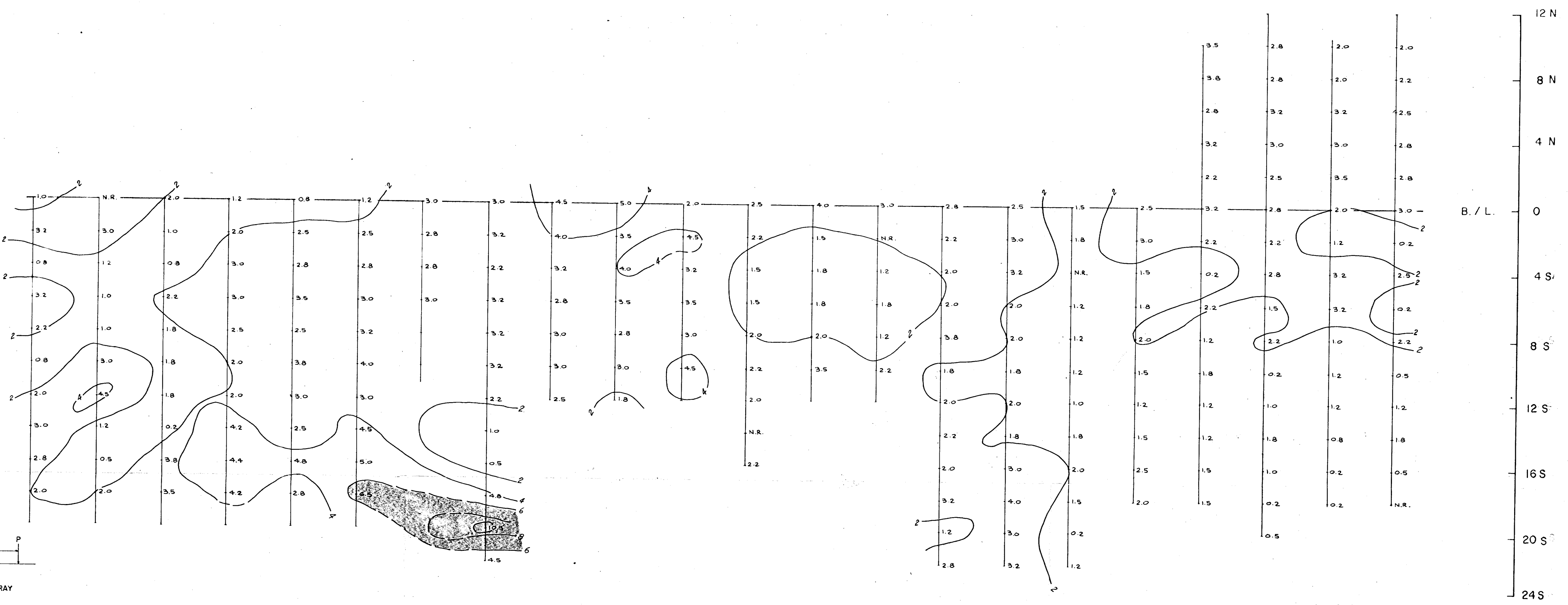

400 FOOT ELECTRODE SPACINGS

LEGEND
 ELECTRODE CONFIGURATION
 C 400' P 400' P
 X PLOTTING POINT
 THREE ELECTRODE ARRAY

—2.5 LINE TRACE WITH CHARGEABILITY VALUES IN MILLISECONDS

—6 CHARGEABILITY CONTOURS 2 MILLISECOND CONTOUR INTERVALS

PLATE 7
 HIGHLAND VALLEY MINES LTD.
 HIGHLAND VALLEY AREA B.C.
 BET I-6 and JOE 6&8 CLAIMS
 INDUCED POLARIZATION SURVEY
 CHARGEABILITY CONTOUR PLAN
 SCALE: 1" = 400'

TO ACCOMPANY A GEOPHYSICAL REPORT BY
 J.G. BAIRD DATED AUGUST 5, 1969

Department of
 Mines and Petroleum Resources
 ASSESSMENT REPORT
 NO. 2012 MAP #7

SURVEY BY SEIGEL ASSOCIATES LIMITED
 MAY, 1969

2012

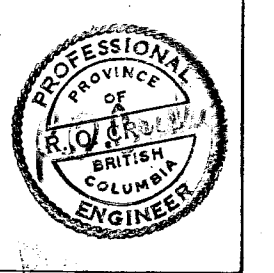

L 64 W L 60 W L 56 W L 52 W L 48 W L 44 W L 40 W L 36 W L 32 W L 28 W L 24 W L 20 W L 16 W L 12 W L 8 W L 4 W L 0 L 4 E L 8 E L 12 E L 16 E L 20 E

12 N
8 N
4 N
0
4 S
8 S
12 S
16 S
20 S
24 S

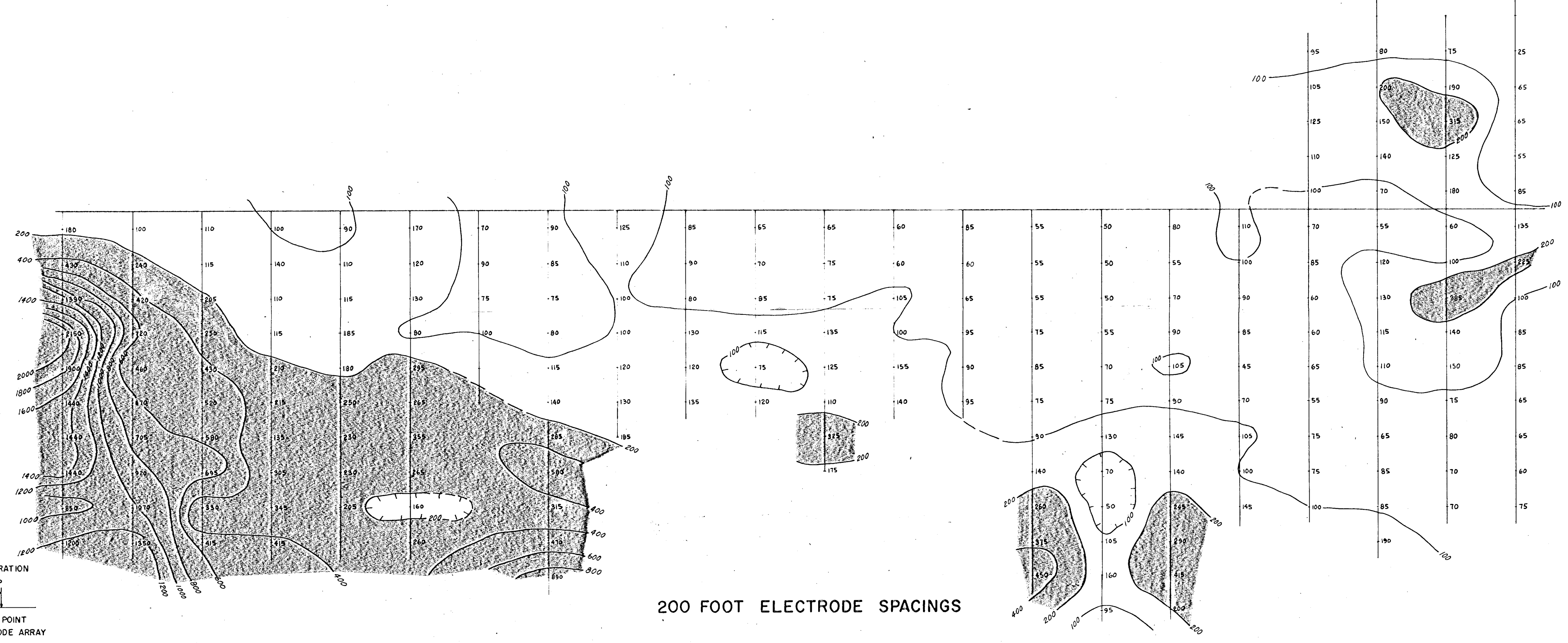

200 FOOT ELECTRODE SPACINGS

L 64 W L 60 W L 56 W L 52 W L 48 W L 44 W L 40 W L 36 W L 32 W L 28 W L 24 W L 20 W L 16 W L 12 W L 8 W L 4 W L 0 L 4 E L 8 E L 12 E L 16 E L 20 E

12 N
8 N
4 N
0
4 S
8 S
12 S
16 S
20 S
24 S

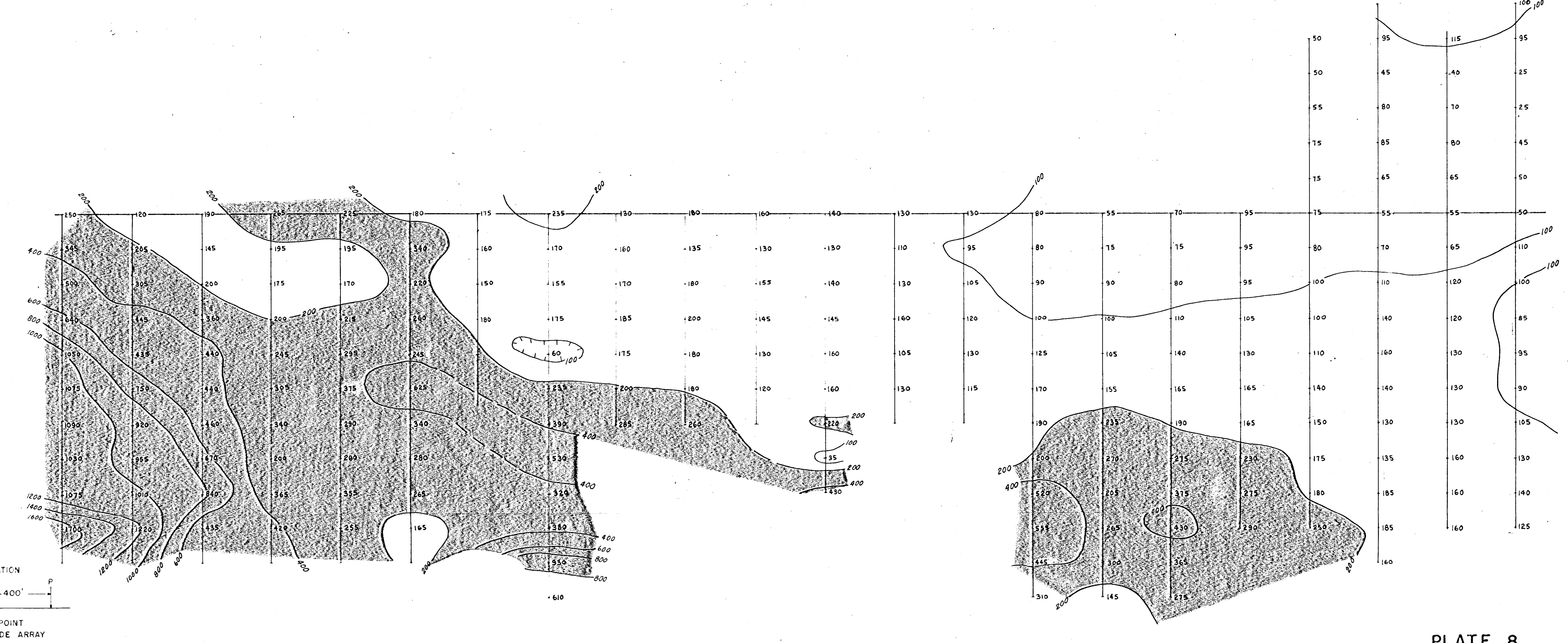

400 FOOT ELECTRODE SPACINGS

LEGEND
ELECTRODE CONFIGURATION
C 200' P 200' P
X PLOTTING POINT
THREE ELECTRODE ARRAY

— 387 LINE TRACE WITH RESISTIVITY VALUES IN OHM-METRES

— 200 RESISTIVITY CONTOURS
200 OHM-METRE CONTOUR INTERVALS

PLATE 8

HIGHLAND VALLEY MINES LTD.
HIGHLAND VALLEY AREA B.C.
BET I-6 and JOE 688 CLAIMS
INDUCED POLARIZATION SURVEY
RESISTIVITY CONTOUR PLAN
SCALE: 1" = 400'

SURVEY BY SEIGEL ASSOCIATES LIMITED
MAY, 1969

TO ACCOMPANY A GEOPHYSICAL REPORT BY
J.G. BAIRD DATED AUGUST 5, 1969

Department of
Mines and Petroleum Resources
ASSESSMENT REPORT
2012 MAP #8

2012

