

22 25

REPORT ON  
INDUCED POLARIZATION SURVEY  
JED CLAIM GROUP  
McLEESE LAKE AREA, BRITISH COLUMBIA  
ON BEHALF OF  
CLEVELAND MINING & SMELTING CO. LTD.

by

Jon G. Baird, B.Sc., P.Eng.

August 20, 1969

CLAIMS:

<u>Name</u>	<u>Record No.</u>
JED 1 - 4	44669 - 44672
JED 17 - 21	44685 - 44689
JED 23, 25	44692, 44694

LOCATION:

About six miles north of McLeese Lake, B.C.  
Cariboo Mining Division  
122° 52° NW

DATES: July 27 to August 3, 1969

### SUMMARY

The present reconnaissance induced polarization survey has not revealed any anomalous chargeability responses.

It is concluded therefore that there is little possibility that a large tonnage, low grade deposit of sulphide mineralization of economic significance may lie within about 300' of the ground surface in the area covered by this survey.

Since the area of greatest geological interest may underlie Rimrock Lake, further induced polarization surveying may be warranted when the lake is frozen.

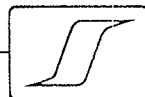
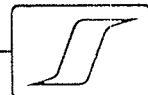

TABLE OF CONTENTS

	<u>Page No.</u>
SUMMARY	
INTRODUCTION	1
GEOLOGY	2
DISCUSSION OF RESULTS	3
CONCLUSIONS & RECOMMENDATIONS	4
PLATES (in text)	
#1 Plate 1 - Location Map	1" = 30 miles
(in envelope)	
#2 Plate 2 - Induced Polarization Survey Results	1" = 200'
Claim & Grid Location	1" = 800'

Department of  
Mines and Petroleum Resources  
ASSESSMENT REPORT

NO. **2225** MAP



REPORT ON  
INDUCED POLARIZATION SURVEY  
JED CLAIM GROUP  
MCLEESE LAKE AREA, BRITISH COLUMBIA  
ON BEHALF OF  
CLEVELAND MINING & SMELTING CO. LTD.

INTRODUCTION

During the period July 27 to August 3, 1969 a geophysical field party under the direction of Mr. Reg Lebrun executed an induced polarization survey in the McLeese Lake area, British Columbia on behalf of Cleveland Mining & Smelting Co. Ltd.

As shown on Plate 1 on the scale of 1" = 30 miles, the property lies approximately six miles north of McLeese Lake. The property is reached by unimproved road from Highway 97. The terrain is hilly and treed as is typical of the Interior Plateau area.

The claims covered by the present survey are listed on the cover page of this report and are shown on the inset of Plate 2, on the scale of 1" = 800'. The JED claims are held by Cleveland Mining & Smelting Co. Ltd.

Seigel Mk VI time domain (pulse-type) induced polarization equipment was employed on this property. The transmitting unit had a rating of 2.5 kw and equal on and off times of 2.0 seconds. The receiving unit was a remote, ground-pulse type triggered by the rising and falling primary voltages set up in the ground by the transmitter. The integration of the transient polarization voltages takes place for 0.65 seconds after a 0.45 second delay time following the termination of the current-on pulse. The accompanying copy of H.O. Seigel's paper entitled "Three Recent Irish Discovery Case Histories Using Pulse Type Induced Polarization" gives a

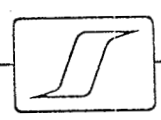

description of the phenomena involved in this type of survey, the equipment employed, the field procedures and the nature of the results obtained over various base metal ore bodies.

The purpose of an induced polarization survey is to map the subsurface distribution of metallicly conducting mineralization beneath the grids covered. In the present area such mineralization could include chalcopyrite, molybdenite, pyrite and other metallic sulphide minerals. As well, metallic conductors such as graphite and magnetite can give responses not always distinguishable from sulphide mineralization.

For the present survey grid lines were laid out 400' apart oriented N 35° W. The grid layout is shown in the inset of Plate 2.

The three electrode array, with electrode spacings of 400' was employed for reconnaissance purposes. Station intervals were 200'.

GEOLOGY

A description of the geology of the area including and surrounding the present claims is found on GSC preliminary map sheet 93B, Quesnel area, by H.W. Tipper, 1959. The area covered by the present property is shown to be underlain by Pleistocene and Recent unconsolidated sediments. East of the claim group lies a Mesozoic granitic intrusive which rises above the surrounding countryside and is called Granite Mountain (El. 4587'). West of the property lies a north-south trending belt of Tertiary volcanic rocks.

Copper-molybdenum mineralization has been observed in the

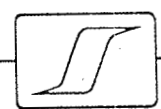

rocks of the Granite Mountain intrusive and the area has a possible potential as a locale for disseminated type mineral deposits.

The main target of the present survey was one of these low grade, large tonnage deposits; the upper surface of which would occur within 300' of the ground surface.

#### DISCUSSION OF RESULTS

Plate 2, on the scale of 1" = 200', shows the geophysical survey results in profile form. Two parameters are plotted, chargeability (the induced polarization characteristic of the rock) and resistivity. The vertical scales of these profiles are 1" = 10 milliseconds for chargeability and 1" = 200 ohm-metres for resistivity.

The observed chargeability values are everywhere less than 6.0 milliseconds and average about 4.0 milliseconds. This is well within the non-metallic chargeability range for granitic rock types, where a uniform distribution of 1% by volume of conducting material in the subsurface is expected to add about 6.0 milliseconds to the observed background chargeability level. Chargeabilities in excess of about 8.0 milliseconds would be considered worthy of further investigation since deposits of very low concentrations of copper and molybdenum of sufficient dimensions may have economic significance.

The resistivity values are generally of the order of a few hundred ohm-metres which is typical for overburden covered granitic rocks in the McLeese Lake area.

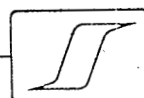

CONCLUSIONS & RECOMMENDATIONS

The present chargeability and resistivity results indicate that the survey area is underlain by rocks of fairly uniform geophysical character. It is concluded that there is little possibility of the presence of a large mass of disseminated sulphide mineralization of the usual porphyry copper dimensions lying within approximately 300' of the ground surface in the area covered by this survey.

It is noted that, due to the grid layout, an area of about the size of one claim in the central portion of the property has not been covered by the present survey. In addition, the area covered by Rimrock Lake has not as yet been investigated. Since it has been suggested that the lake may indicate the location of a fault or contact, induced polarization coverage of this area under winter conditions may be warranted.

Respectfully submitted  
SEIGEL ASSOCIATES LIMITED

*Jon G. Baird*

Jon G. Baird, B.Sc., P.Eng.  
Geophysicist

Vancouver, B.C.  
August 20, 1969

*R. O. Crosby*

R. O. Crosby, B.Sc., P.Eng.  
Geophysicist

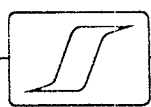

Harold O. Seigel

President,  
Harold O. Seigel & Assoc., Ltd.,  
Downsview, Ontario

Annual General Meeting,  
Toronto, March, 1965

# Three Recent Irish Discovery Case Histories Using Pulse-Type Induced Polarization

Transactions, Volume LXVIII, 1965, pp. 343-348

## ABSTRACT

In the intensive Irish exploration program which has followed the discovery of the Tynagh deposit (Northgate Exploration, Ltd.) in 1962, three base metal discoveries have been made to date. These include the lead-zinc-silver deposits at Silvermines (Consolidated Mogul Mines, Ltd.), which are now being readied for production, the copper-silver deposit at Gortdrum (Gortdrum Mines, Ltd.) and the lead-zinc deposits near Keel (Rio Tinto-Zinc Ltd.). Each of these discoveries is the result of a combined geological-geochemical-geophysical exploration sequence in which pulse-type induced polarization surveys defined the precise location and lateral extent of the near-surface metallic sulphide mineralization and guided the initial drilling program. Whereas the Silvermines mineralization is, in part, composed of massive sulphides, the other two deposits are characterized by generally less than 5 per cent conducting sulphides and constitute an excellent demonstration of the unique merits of the pulse-type induced polarization system.

## Introduction

FOR the benefit of those who are unfamiliar with the induced polarization method in general or with the pulse-type method in particular, a few introductory remarks will be directed on the system employed in the present case histories. Those who wish a fuller treatment of the subject are directed to Seigel (1962),\* which paper also includes an extensive list of references.

Induced polarization, in its broadest sense, means a separation of charge to form an effective dipolar (polarized) distribution of electrical charges throughout a medium under the action of an applied electric field. When current is caused to pass across the interface between an electrolyte and a metallic conducting body (Figure 1a) double layers of charge are built up at the interface, in the phenomenon known

\*Seigel, H. O., "Induced Polarization and its Role in Mineral Exploration," C.I.M. *Bulletin*, Vol. 55, No. 600, pp. 242-249; *Transactions*, Vol. LXV, pp. 151-158; 1962.

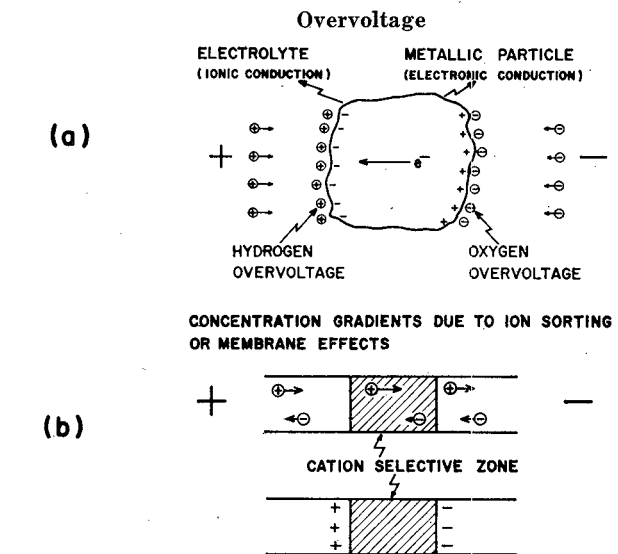

Figure 1.—Induced Polarization Agents.

to the electrochemists as "overvoltage." This is the phenomenon which can be utilized for the detection of the metallic conducting rock-forming minerals such as most sulphides, arsenides, a few oxides and, unfortunately, graphite. In addition, effective dipolar charge distributions occur to some extent in all rocks, due to ion-sorting or membrane effects in the fine capillaries in which the current is passing (Figure 1b). Induced polarization responses may therefore arise from metallic or non-metallic agencies. Fortunately, the latter generally fall within fairly low and narrow limits for almost all rock types, although there is still no reliable general criterion for differentiating overvoltage responses from graphite and metallic sulphides, or for distinguishing between the responses of one type of sulphide and another. Despite these limitations, the induced polarization method has amply demonstrated its value in mineral exploration since its initial development as a useful exploration tool in 1948. (Wait *et al.*, 1953).\*\*

\*\*"Overvoltage Research and Geophysical Applications," Pergamon Press, 1959, edited by J. R. Wait.



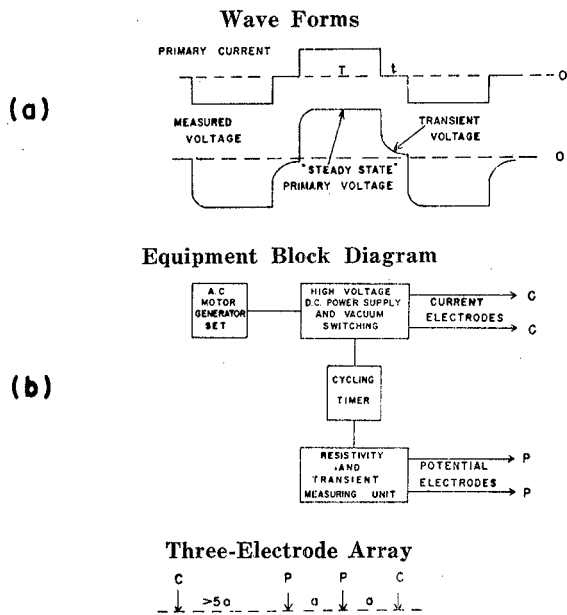

Figure 2.—The Pulse System.

### Description of Method

For the present program, the pulse or time-domain system was employed. As shown in Figure 2a, the primary current wave form consists of square wave pulses of 1.5 seconds duration, separated by a 0.5-second gap and alternately reversed in direction. The polarization voltages established during the current-on time decay slowly during the current-off time. They are amplified, integrated over the current-off time and divided by the amplitude of the steady-state voltage measured during the current-on time. In this way, we determine the "chargeability;" i.e., the induced polarization property of the region under investigation. The units of chargeability are milliseconds. Normal (non-metallic) background chargeabilities in most rocks range from 1 millisecond to 5 milliseconds. A distribution of 1 per cent, by volume, of metallic conducting material of an average range of

particle size may be expected to increase the response level by about 3 milliseconds, which is readily visible.

The pulse system provides an absolute measurement of induced polarization; i.e., the significant measurement is made in the absence of the primary field. As such, it is inherently more sensitive than the frequency variation system, wherein two measurements are compared, both of which are made in the presence of the primary field. This is a critical consideration when mineralized bodies of low sulphide content, small size or great depth are being sought.

Figure 2b shows a block diagram of the apparatus employed and the electrode array used. The spacing "a" of the three-electrode array determines the effective depth of penetration of the survey and is selected to give adequate penetration to the depth desired. By varying the electrode spacing over an anomalous area and comparing the responses on the various spacings, one may obtain an estimate of the depth of burial of the source and its dip, etc.

A photograph of the type of apparatus employed on these surveys is shown in Figure 3. This is known as Seigel Mk V equipment and consists of the following major components: (a) a 1,200-watt A.C. motor-generator set, (b) a power control unit capable of supplying up to 1000 volts and 2 amperes D.C. output current and (c) a measuring unit. All of these items are packboard-mounted for maximum portability.

Figure 4 shows a typical instrumental set-up in Ireland. In the normal operating procedure, the electronic chassis are set up in a tent and cables are fed out to the line being surveyed. As the line crew is prepared, both mentally and by apparel, to work under all types of weather conditions, the survey is not stopped by rain, etc. This is important in Ireland, where, traditionally, there are no more than 60 rain-free days a year.

For the primary survey coverage on most properties, an electrode spacing of 200 to 300 ft. was generally employed, with a station interval of 200 ft. and a line separation of 300 to 500 ft. On anomalous areas located by the primary coverage, more closely spaced stations and lines are employed, as well as additional spacings to supply the detail necessary for subsequent drilling, etc.

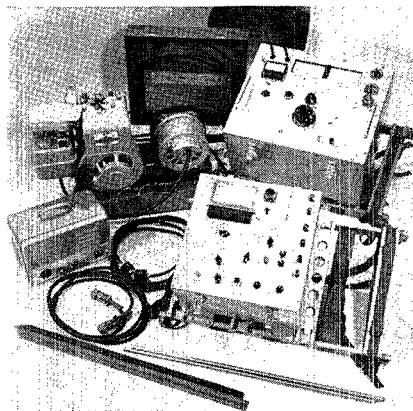

Figure 3.—(above)—The Seigel Mk V Induced Polarization Unit.



Figure 4.—(right)—Typical Field Operational Base in Ireland.

## Case Histories

In presenting the three case histories that follow, it must be made perfectly clear at the outset that these mineral discoveries are the product of teamwork, involving geological, geochemical and geophysical phases. It is on the basis of the first two phases that the areas for geophysical investigation have been selected. As the writer and his organization have been concerned only with the geophysical phase, this paper will, naturally, appear to emphasize it. The contribution of others to the broader exploration program must not be minimized, however.

In January, 1962, a large lead-zinc-silver deposit of a very unusual type was discovered near Tynagh, Co. Galway, in the Republic of Ireland. This deposit includes both a supergene enriched, partly oxidized upper zone and a sulphide primary zone and lies in dolomitic reef limestones of Carboniferous age near a fault contact with Devonian sandstones. Similar rock types and contacts occur in many parts of Ireland, so that an extensive program of exploration was initiated by a number of mining companies, starting in the summer of 1962. Although the pace has slowed up somewhat from the hectic days of 1962 and early 1963, this exploration program continues to the present time.

The usual exploration sequence, although not followed in detail by all companies, is as follows:

1 . . . . .

A selection of areas is made, based on the good government geological maps available. As nearly as possible, rock types and structures similar to those of the Tynagh deposit are sought. Those areas with known mineral showings are given high priority, of course.

2 . . . . .

The stream sediments in the drainage pattern are sampled and analyzed for significant amounts of copper, lead and zinc. Soil samples may also be taken, often on a regular grid basis, and analyzed. In this fashion, areas of abnormal metal content may be broadly defined. In detail, such geochemical sampling has often been hampered by man-made contamination and confused by soil transport by glacial, fluvial or human agencies.

3 . . . . .

Geophysical surveys, primarily the induced polarization type, are then conducted to map the subsurface distribution of sulphide mineralization and to provide guidance for a drilling program thereon.

This exploration program has already been remarkably successful, resulting, to date, in a new lead-zinc-silver mine-to-be at Silvermines, Co. Tipperary, for Consolidated Mogul Mines, Ltd., the probable copper-silver mine-to-be at Gortdrum, Cos. Tipperary and Limerick, for Gortdrum Mines, Ltd., and the interesting lead-zinc prospect at Keel, Co. Longford, for the Rio Tinto-Zinc group (Riofinex Ltd.). Figure 5 shows the location of the various recent mineral discoveries in Ireland. Despite a remarkable similarity in geological setting, the deposits are widely separated geographically, over a length of 80 miles, and no two are located on what can be called the same structure. This bodes well for the possibility of further discoveries being made in Ireland.

Each of the three case histories will be discussed below.

## Silvermines Deposit

As the very name of the area implies, the Silvermines region had been known, for many centuries, as a locality mineralized with lead, zinc and silver. Metal production had taken place at several periods in the past, although at the time of the present investigations the mines were dormant. The very prominent Silvermines fault, striking about N 70°E, was known to be the significant control in the region, with the old mines and prospect pits scattered along its length over a distance of about 2 miles. Due to the past mining activity and transport by both drainage and man, a very extensive area gave rise to extremely high geochemical indications in lead and zinc. The induced polarization survey executed in late 1962 and early 1963 covered much of the concession area on 800-ft. sections and the geologically interesting portion thereof on 400-ft. sections. The three-electrode array, with 200-ft. electrode spacing, was employed on all lines, and spacings of 100 ft. and 400 ft. were also employed on the 400-ft. detail lines. In all, approximately 5 miles of the strike length of the Silvermines fault were covered by the present survey, 2½ miles in detail. At least ten distinct zones of abnormally high polarization were indicated, of which about half lay in the Silvermines mineralized belt and its extensions to the west and east.

One of these zones, designated the Garryard, has responded favourably to the subsequent drilling, resulting in the discovery of a mineable orebody.

To date, the announced proven tonnage figures include 12 million tons averaging approximately 8 per cent zinc, 3 per cent lead and 1 ounce of silver in the Garryard zone. This zone lies to the west of the zone from which the previous production had taken place.

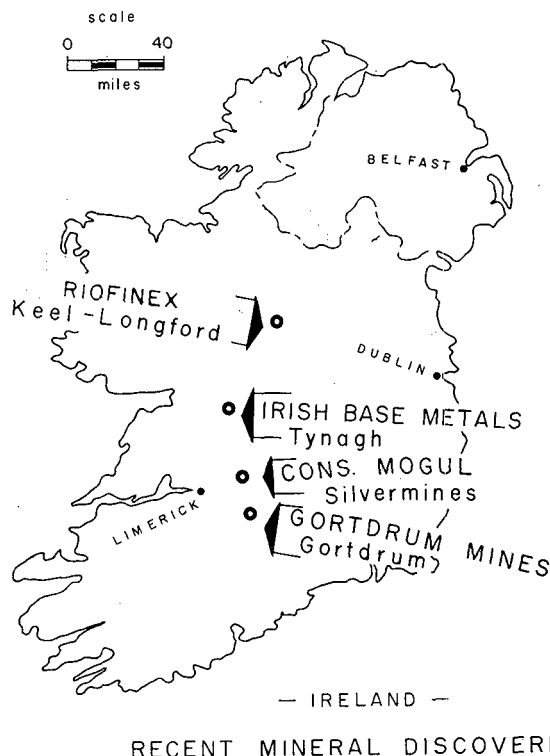

Figure 5.—Location Plan of Recent Mineral Discoveries in Ireland.

Figure 6 shows a typical discovery profile across the main ore zone, on the section 38,400E. The 200-ft. electrode spacing results, both chargeability and resistivity, are shown in profile form. The geologic section, as deduced from nine drill holes, is shown below the geophysical profiles. In a fashion almost identical

to that of the Tynagh deposit, the Silvermines ore-body is located in gently north-dipping dolomitic limestones adjacent to a fault contact with the Devonian "Old Red" sandstone. The mineralization here is composed of both massive and disseminated sulphides, with the former composed of a high percentage of pyrite. The mineralization is essentially conformable, in two distinct horizons, and is therefore flatly dipping except in the vicinity of the fault, where the dips are much steeper, perhaps due to "drag folding" on the fault.

Because of the high pyritic content of the mineralization near the fault, along which it comes closest to the ground surface, we see both a marked increase in chargeability and a sharp decrease in resistivity in that vicinity. From a normal background of 2-4 milliseconds, the chargeability curve rises to a peak response of 20 milliseconds over the sub-outcrop of the body on this section. The subsidiary peak of about 12 milliseconds near 11N is believed to be due to disseminated pyrite in the chert horizon.

Figure 7 shows the multiple spacing chargeability results on the same section, using electrode spacing of 100, 200 and 400 ft. and the three-electrode array. On comparing the results with the various spacings, two items of interest may be noted; firstly, the progressive increase in peak amplitude with spacing, testifying to the increase of mineralization with depth, even down to a depth of 300 ft., and, secondly, the presence of buried material of high polarization at depth beneath section 10N to 18N on this line. The latter is undoubtedly due to the down-dip extension of the upper mineralized horizon, which is present at depths of 300 to 400 ft. over this region.

The induced polarization results on the Silvermines deposit were quite definitive and have provided good guidance for the exploratory drilling. It is true, however, that the massive sulphide portions of this deposit would be amenable to detection by the more conventional electrical methods, such as electromagnetic induction or resistivity. As such, it is not as good a test of the capabilities of the induced polarization method as are the two case histories which follow.

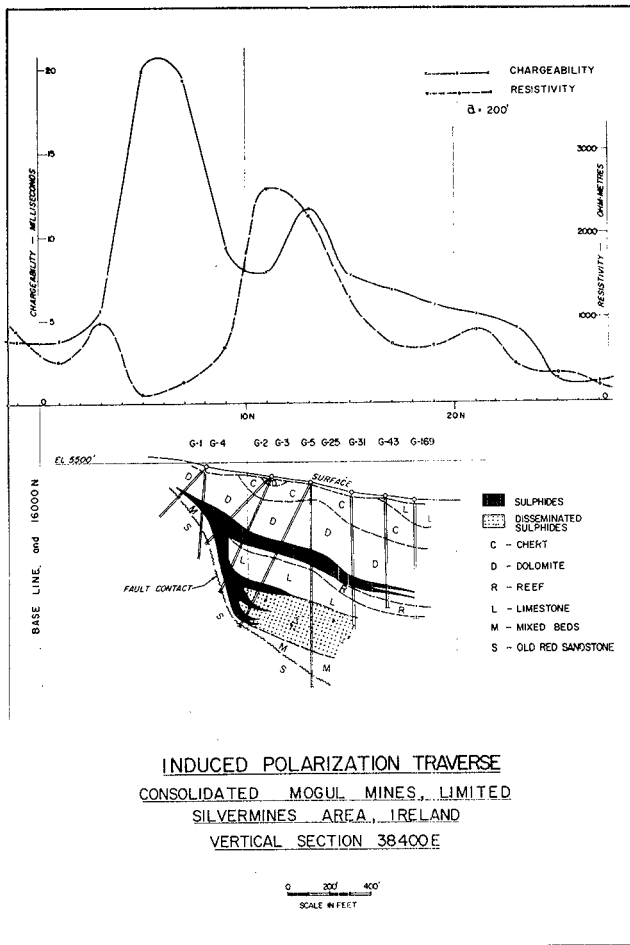

Figure 6.—Typical Discovery Traverse, Silvermines Deposit.

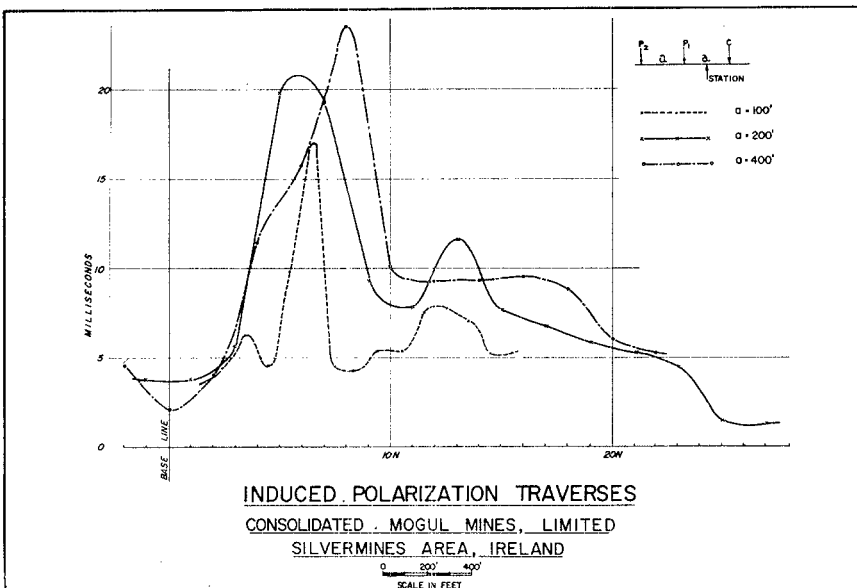

Figure 7.—Multiple Spacing Results, Silvermines Deposit.

### Gortdrum Deposit

The Gortdrum area, near the mutual border of Cos. Limerick and Tipperary, was originally selected to cover the eastern extension of the former Oola Mines lead-zinc deposit, some 3 miles to the west. Regional geochemical sampling of the stream sediments in this area, followed by soil traverses, indicated a moderately strong copper soil anomaly. Induced polarization surveys were carried out in May, 1963, and January, 1964, leading to the localization of the sulphide mineralization associated with the geochemical anomaly. As there was a 300-ft. lateral displacement between the centers of the geophysical and geochemical indications and the surface topography is very gentle, it was initially queried as to whether the two indications

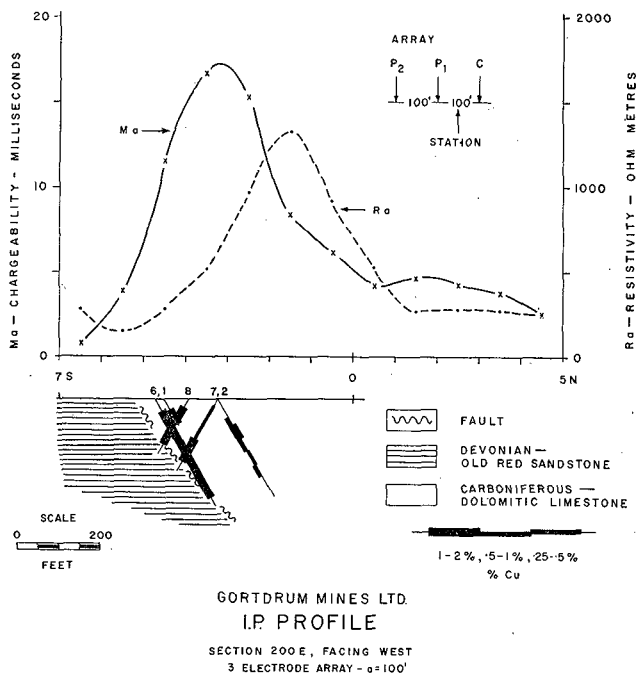

Figure 8.—Typical Discovery Traverse, Gortdrum Deposit.

were related. The subsequent drilling has fully confirmed the geophysical predictions.

On the initial two geophysical programs, the three-electrode array with 100-ft. spacing was employed, as a relatively shallow source of the geochemical anomaly was expected. The survey lines were at 200-ft. intervals. Figure 8 presents a typical discovery traverse, showing both the chargeability and resistivity profiles as well as the corresponding geologic section. A peak chargeability of about 17 milliseconds is observed, rising from the normal background of 2-4 milliseconds. There is no resistivity expression of the mineralized zone, lying as it does on the flank of a high-resistivity area.

Figure 9 shows the chargeability profiles for electrode spacings of 50, 100 and 200 ft. Points of special interest deduced from these profiles include the following:

- 1.—The extremely sharp cut-off of the high chargeability levels on the south side of the area and the gradual drop-off in level on the north side. This was inconsistent with the thought of a bedded-type deposit conformable with the limestones, which are known to dip flatly to the south. A fault or other contact was postulated, dipping steeply, probably to the north. The initial drill holes on the section (Nos. 1, 2 and 6) were drilled to the north on the original geologic-dip premise, but the later holes (e.g., Nos. 7 and 8) have all been drilled to the south.

- 2.—The high-polarization material does not quite outcrop, but still comes within about 25 ft. of the ground surface across a width of about 200 ft., including two or more lenses. This material extends to at least 200 ft. in depth.

The actual drilling results confirm the presence of a zone of finely disseminated chalcocite and bornite, with very minor chalcopyrite, in dolomitic limestones. The mineralization is somewhat erratically distributed but, in general, increases as one approaches a north-

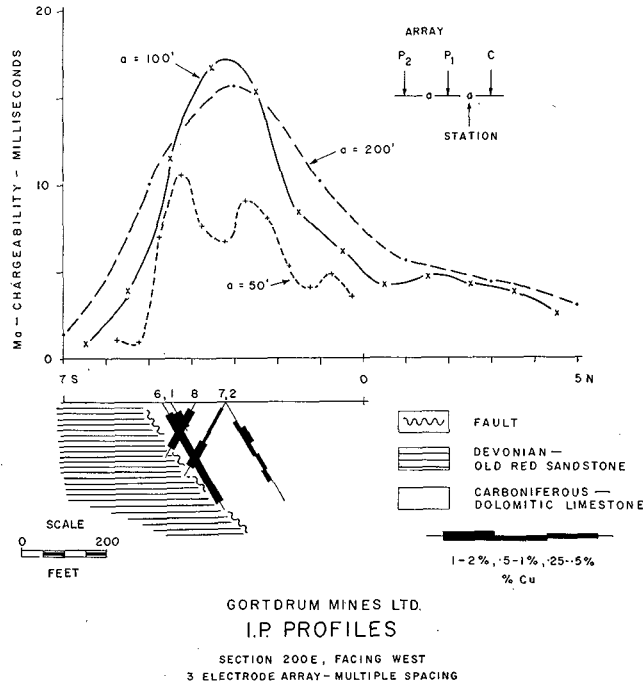

Figure 9.—Multiple Spacing Results, Gortdrum Deposit.

dipping fault, which brings the limestones into contact with the Devonian Old Red sandstones. This fault has been found to strike about N 70°E. Geologically, therefore, this environment is almost identical to that of the Tynagh and Silvermines deposits. The mineralization in the Gortdrum area is quite different, however, both in type and amount. The average grade of the deposit is less than 2 per cent copper, with about 0.65 ounce of silver for each 1 per cent copper (although considerable potential open-pit tonnage may exist), so that the average sulphide content, by volume, is 3 per cent or less. The high chargeability responses observed over this deposit are a remarkable tribute to the sensitivity of the pulse-type induced polarization method, particularly when dealing with truly disseminated-type sulphide mineralization with a small average particle size.

As development drilling is still in progress on this deposit, no over-all grade or tonnage figures have as yet been released.

### Keel Deposit

The deposits near Keel and Longford, Co. Longford, occur on a known limestone-sandstone contact, which is, no doubt, one of the reasons why exploration interest was attracted thereto. Soil sampling traverses by Riofinex Ltd., an exploration subsidiary of Rio Tinto-Zinc Corporation, Ltd., established the presence of anomalous lead and zinc concentrations. A horizontal-loop electromagnetic survey was initially executed in another attempt to determine the source of the geochemical indications, but with negative results. This was followed by induced polarization surveys in November and December, 1962. The three-electrode array, with an electrode spacing of 200 ft., was employed on the reconnaissance survey. Anomalous chargeability zones were indicated and exploratory drilling commenced shortly thereafter. Although no publication of results has been made, they are of some potential interest, as drilling has continued, at intervals, to the present time.

Figure 10 shows a typical section across the prospect, presenting the geophysical and geochemical results in profile form, as well as the geological section interpreted from three holes. The relationship between the mineralized horizon, the geophysical peak and the geochemical peaks is a matter of considerable interest. The sub-outcrop of the mineralized horizon and the geophysical peak are in good agreement (see also Figure 11). The lead peak is displaced about 400 - 500 ft. down slope to the south. The zinc peak

is displaced still another 300 ft. to the south. The actual topographic slope is only 1-2 degrees to the south, so that this displacement is difficult to account for on the basis of soil creep. There is only a minor resistivity depression associated with the mineralization, indicating why the electromagnetic survey failed to give any positive response to it.

The mineralization itself is primarily sphalerite, with some galena and, on the average, less than 5 per cent pyrite. It is found to lie primarily in a dolomite horizon adjacent to a contact with sandstone. In this case, the contact may be largely a depositional one and not due to a fault. Mineralization occurs to a minor extent in the sandstone as well.

Figure 11 shows the chargeability results of the multiple spacing profiles on this section. Spacings of 50, 100 and 200 ft. were used. The progressive step-out of the peak values to the south with the increase in electrode spacing indicates the effect of the relatively flat dip to the south of the mineralization. The sub-outcrop of the mineralization is near station 26N, at a depth of less than 25 ft. As hole K3B, only 100 ft. away, intersected almost 60 ft. of overburden one must conclude that the bedrock surface is rather irregular in this area. The peak chargeability of 24 milliseconds would suggest a metallic conductor content of the order of 6 to 12 per cent, by volume, in this area.

It is the writer's hope that he has not given the impression that every induced polarization anomaly in Ireland inevitably defines an orebody, or that every exploration venture there is crowned with success. Aside from effects due to the many man-made conductors, such as grounded power lines, rabbit fences and buried pipe lines, there are certain carbonaceous sediments, in particular the Calp limestone, which overlies the ore-bearing dolomitic limestone in some places, which yield high polarization responses. Fortunately, the areal distribution of the latter is usually broad enough to suggest a formational origin. Also, fortunately, the Calp is, stratigraphically, sufficiently well separated from the ore-bearing limestones so that the effect from these two horizons may be resolved. With the geological and geochemical information available, one can usually determine whether a particular induced polarization indication warrants investigation by drilling. Despite its limitations, the pulse-type induced polarization method has well demonstrated its application to a broad range of base metal exploration problems in Ireland.

### Acknowledgments

The writer wishes to express his thanks to Consolidated Mogul Mines, Ltd., and Dr. W. W. Weber, to Gortdrum Mines, Ltd. and Dr. D. R. Derry, and to Rio Tinto-Zinc Corp. Ltd. and Mr. Jocelyn Pereira, for their kind permission to present the geophysical and other details relating to their respective mineral discoveries. In addition, the writer wishes to acknowledge the able assistance of the staff of Canadian Aero Mineral Surveys, Ltd., with which our company, Harold O. Seigel & Associates Ltd., has acted on a co-operative basis in Ireland.

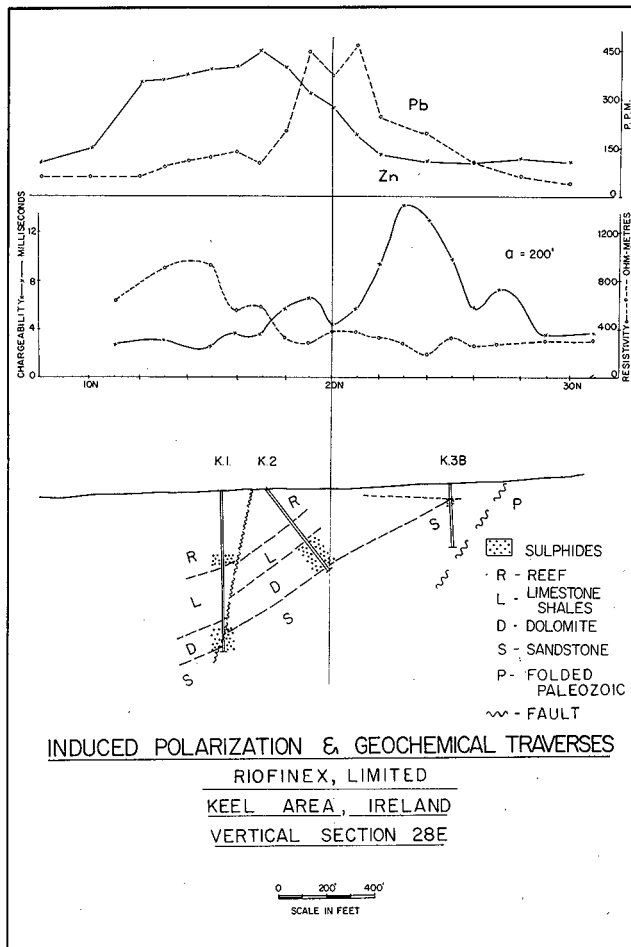

Figure 10.—Typical Discovery Traverse, Keel Deposit.

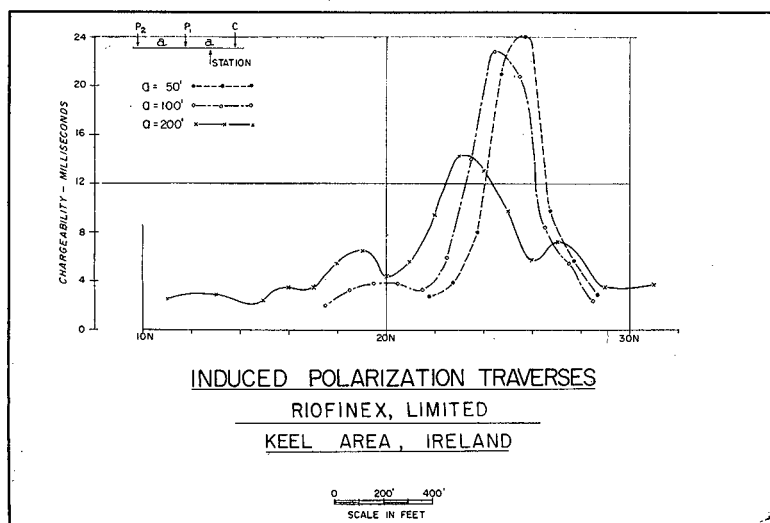

Figure 11.—Multiple Spacing Results, Keel Deposit.

*(Reprinted from The Canadian Mining and Metallurgical Bulletin, November, 1965)*

Printed in Canada

DOMINION OF CANADA:  
PROVINCE OF BRITISH COLUMBIA.  
To Wit:

In the Matter of a geophysical survey on behalf of  
Cleveland Mining & Smelting Co. Ltd.

I, J. G. Baird for Seigel Associates Limited

of 750 - 890 West Pender Street, Vancouver

in the Province of British Columbia, do solemnly declare that an induced polarization survey has been executed on some JED claims, about six miles north of McLeese Lake, B. C., between July 27 to August 3, 1969. The following expenses were incurred:

(1) Wages:				
	R. Lebrun	8 days @ \$35.00/day	\$280.00	
	J. Hofer	8		
	G. Potvin	8		
	R. Albert	<u>8</u> 24 days @ \$27.50/day	<u>660.00</u>	\$940.00
(2) Transportation & shipping to the property				225.75
(3) Food & Living Expenses				382.25
(4) Use of Geophysical Equipment				
		8 days @ \$50.00/day		400.00
(5) Consulting Fees:				
		5 days @ \$170.00/day	\$850.00	
		3 days @ \$85.83/day	<u>257.50</u>	<u>1,107.50</u>
				\$3,055.50

And I make this solemn declaration conscientiously believing it to be true, and knowing that it is of the same force and effect as if made under oath and by virtue of the "Canada Evidence Act."

Declared before me at the City  
of Vancouver, in the  
Province of British Columbia, this 14  
day of January 1969, A.D.

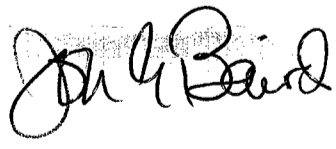

Jan Sumner  
A Commissioner for taking Affidavits within British Columbia or  
A Notary Public in and for the Province of British Columbia. SUB-MINING RECORD

**In the Matter of**

---

---

---

---

---

---

---

---

**Statutory Declaration**  
(CANADA EVIDENCE ACT)

---

---



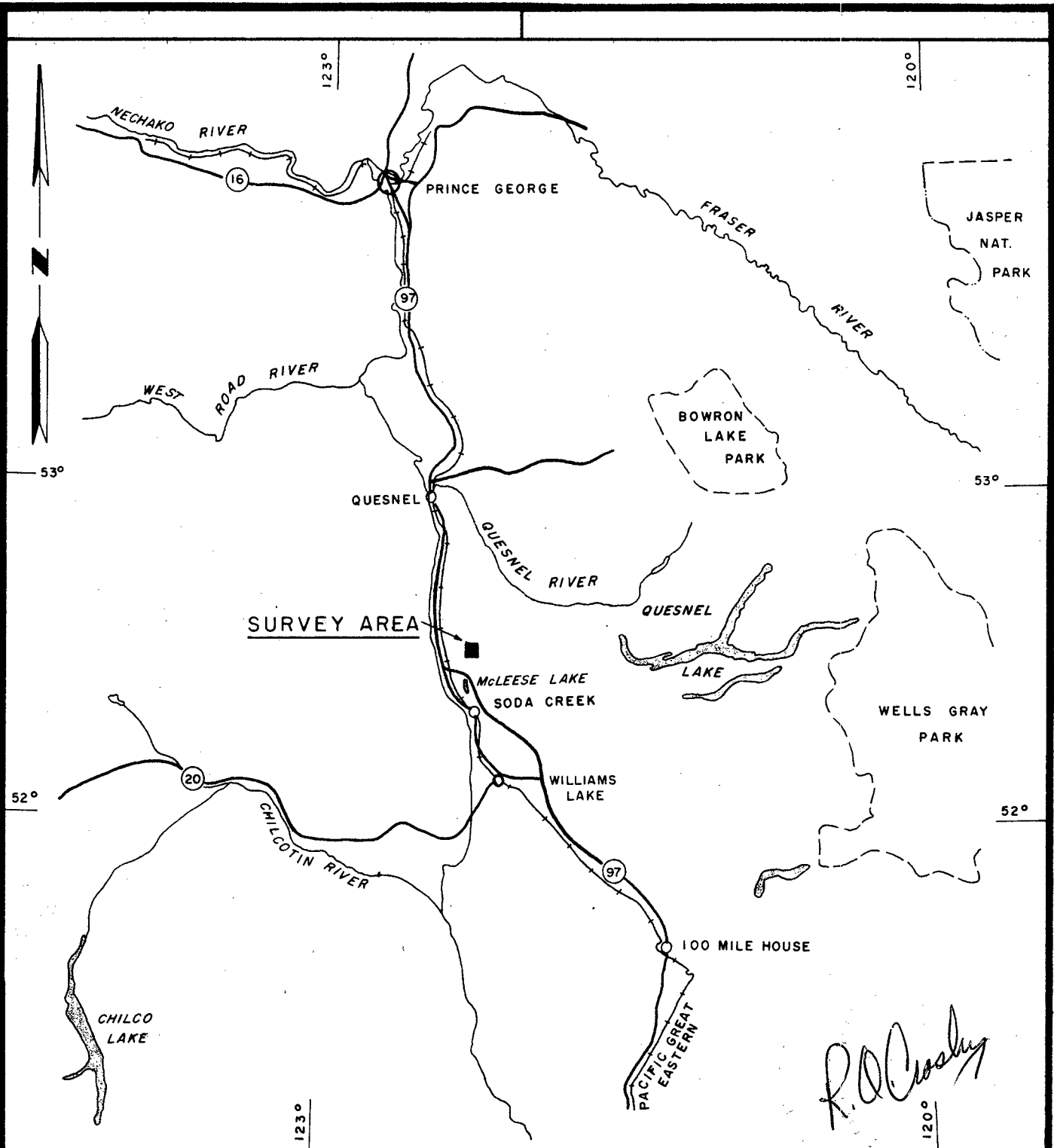

*R. O. Crosby*

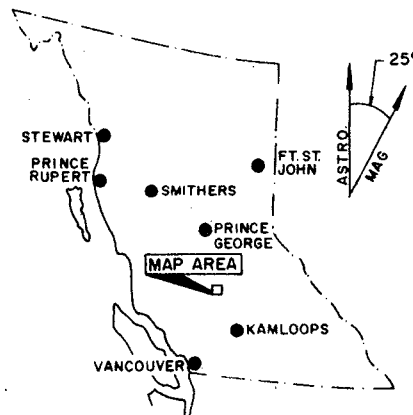

BRITISH COLUMBIA

**CLEVELAND MINING & SMELTING CO. LTD.**

**LOCATION MAP**  
**JED CLAIM GROUP**

**McLEESE LAKE AREA, BRITISH COLUMBIA**



SEIGEL SURVEY BY ASSOCIATES LIMITED  
AUGUST 69

PLATE I

Department of  
Mines and Petroleum Resources  
ASSESSMENT REPORT

NO. **2225** MAP **#1**

July 15, 1969  
Box 3, McLeese Lake, B.C..

Mr. Robert Lefferson,  
McLeese Lake, B.C..

In account with:-

Cleveland Mining & Smelting Co. Ltd.  
615-850 West Hastings St.,  
Vancouver 1, B.C..

7900' of line cutting @ \$100.00 per mile	\$ 150.00
34,400' of line cutting @ \$125.00 per mile	<u>812.50</u>
	962.50
Less advance from J. Pat Gouthro	<u>265.00</u>
Balance owing	697.50

This job was done on the JED mineral claims at Rim Rock Lake.

*Paid \$962.50  
Charge to McLeese Lake Claims*

*Re-issued by CK # 1511  
17/7/69  
\$962.50*

0 2S 4S 6S 8S 10S 12S 14S 16S 18S 20S 22S 24S 26S 28S

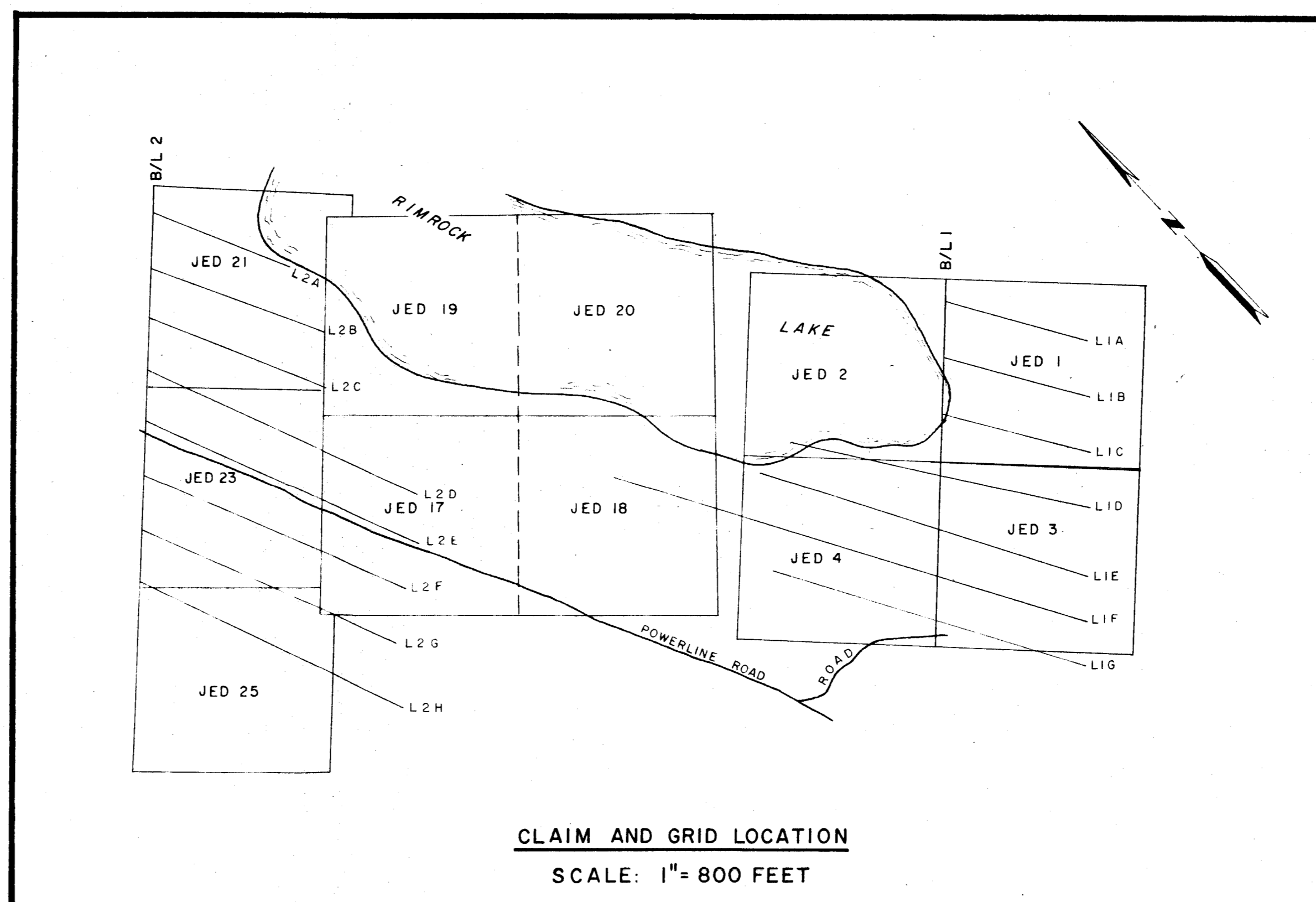
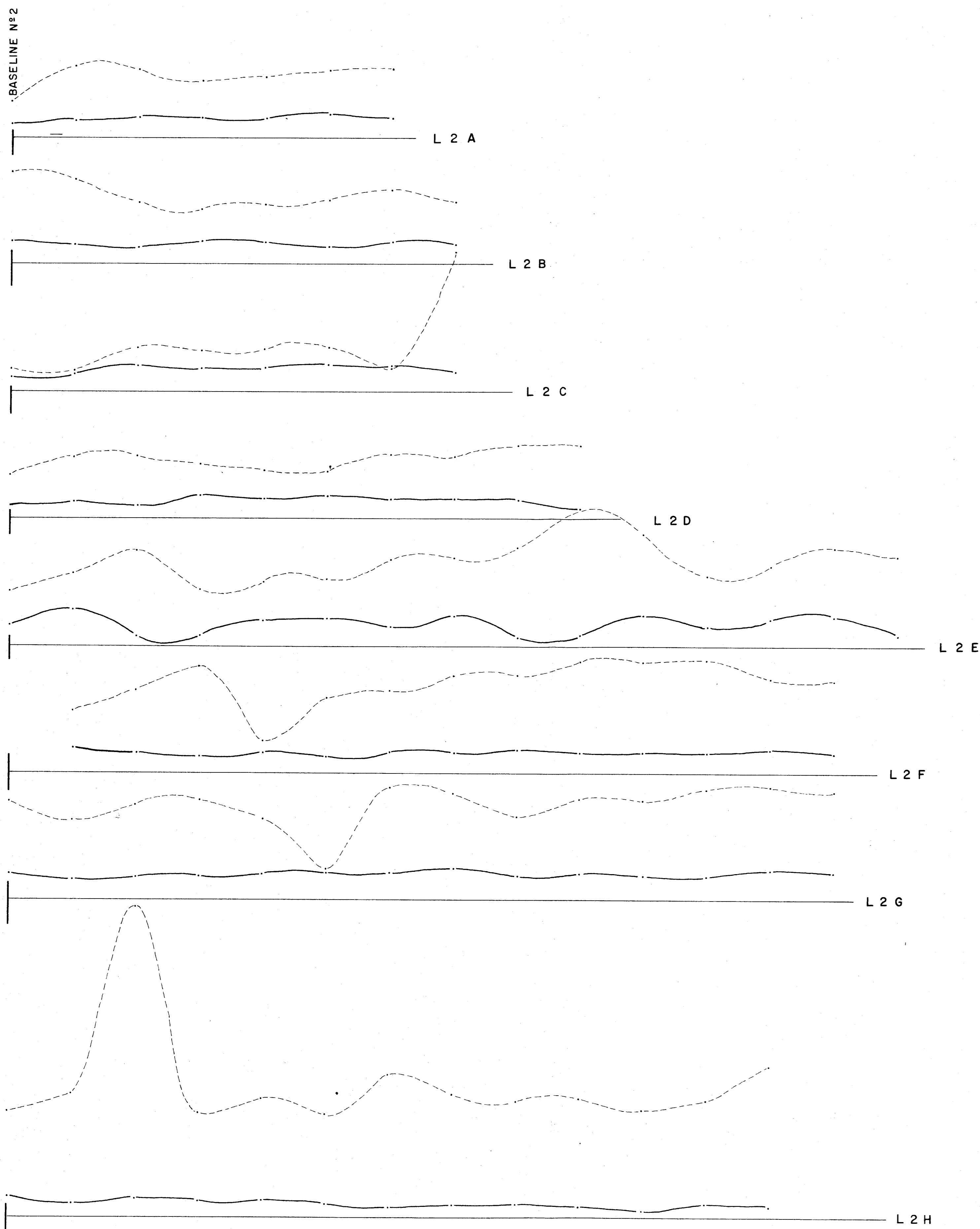

14N 12N 10N 8N 6N 4N 2N 0 2S 4S 6S 8S 10S 12S 14S 16S 18S

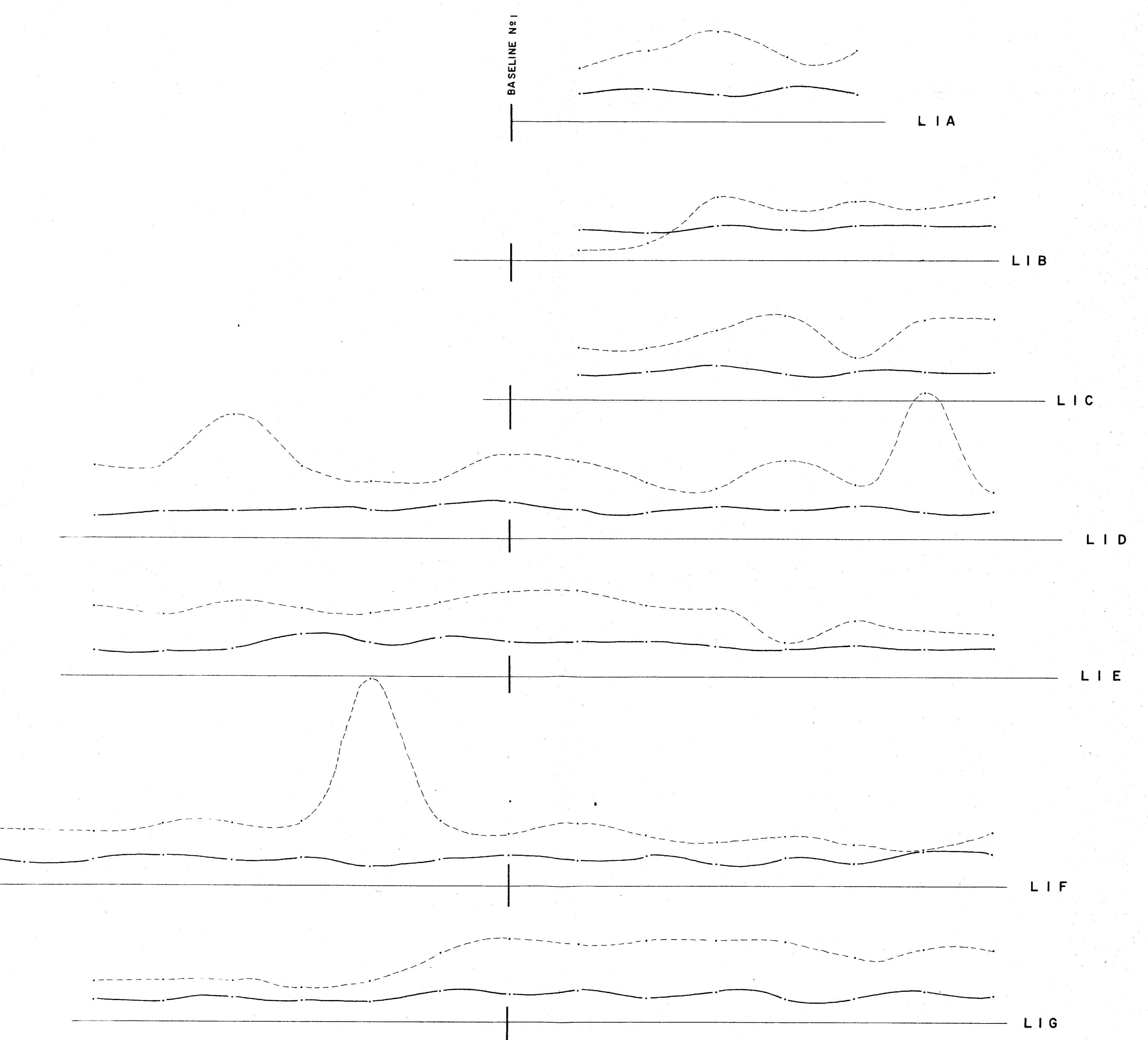

**LEGEND:**

CHARGEABILITY: SCALE: 1 INCH = 10 MILLISECONDS  
ELECTRODE SPACING:  $\sigma = 400'$   
RESISTIVITY: SCALE: 1 INCH = 200 OHM-METRES  
ELECTRODE SPACING:  $\sigma = 400'$

**NOTES:**

SEIGEL MK VI INDUCED POLARIZATION DATA  
THREE ELECTRODE ARRAY

Department of  
Mines and Petroleum Resources  
ASSESSMENT REPORT  
NO. 2225 MAP #12

TO ACCOMPANY A GEOPHYSICAL REPORT  
BY J.G. BAIRD DATED AUGUST 20, 1969

PLATE 2  
CLEVELAND MINING & SMELTING CO. LTD.  
MCLEESE LAKE AREA BRITISH COLUMBIA  
JED CLAIM GROUP  
INDUCED POLARIZATION SURVEY

SCALE: 1 INCH = 200 FEET

SURVEY BY SEIGEL ASSOCIATES LIMITED  
AUGUST, 1969

2225

*Richard O'Leary*