

4246

REPORT ON
INDUCED POLARIZATION SURVEY
MANSON CREEK AREA, BRITISH COLUMBIA
ON BEHALF OF
SULLIVAN AND RODGERS

93N/10E

by

Peter J. Fominoff, B.A.Sc., P.Eng.

and

Michael J. Lewis, M.Sc.

October 27, 1972

CLAIMS:

Name

IDA 103-119 (inclusive)

IDA 132-148 (inclusive)

IDA 150, 152

LOCATION:

About 100 miles north of Ft. St. James, B. C.

In Manson Creek, B. C.

Omineca Mining District

124° 55' NE

DATES:

September 11 to September 27, 1972

Department of
Mines and Petroleum Resources

ASSESSMENT REPORT

NO. 4246 MAP

CONTENTS

	<u>Page No.</u>
SUMMARY	
INTRODUCTION	1
DESCRIPTION OF METHOD AND INSTRUMENTATION	1
THE SURVEY GRID	3
GEOLOGY	3
PRESENTATION OF RESULTS	3
DISCUSSION OF RESULTS	4
CONCLUSIONS AND RECOMMENDATIONS	7
SPECIFICATION SHEET: Induced Polarization Method by Dr. H. O. Seigel	

FIGURES AND PLATES

#1 Figure 1 - Location Map	Scale 1:250,000
Figure 2 - Three Electrode Array	
#2 Plate 1 - Chargeability Profiles	Scale 1 inch = 400 feet
#3 Plate 2 - Resistivity Profiles	Scale 1 inch = 400 feet
#4 Plate 3 - Chargeability Contour Plan	Scale 1 inch = 400 feet
#5 Plate 4 - Resistivity Contour Plan	Scale 1 inch = 400 feet
#6 Plate 5 - Detail Profiles	Scale 1 inch = 100 feet
#7 Plate 6 - Survey Grid and Claim Location Map	Scale 1 inch = 3000 feet



SUMMARY

The present induced polarization survey has shown large portions of the grid area to be underlain by chargeable material. In general, zones of high chargeability are observed to coincide with Zones of low resistivity.

It is recommended that the results of the induced polarization survey be correlated with known geology and geochemistry. If drilling is then warranted, seven diamond drill hole locations have been suggested. Suggested drilling totals 3400 feet.

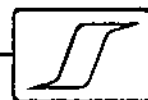

REPORT ON
INDUCED POLARIZATION SURVEY
MANSON CREEK AREA, BRITISH COLUMBIA
ON BEHALF OF
SULLIVAN AND RODGERS

INTRODUCTION

During the period September 11 to September 27, 1972, an induced polarization survey was carried out in the Manson Creek area, British Columbia by Scintrex Surveys Limited on behalf of Sullivan and Rodgers. The survey crew was under the direction of Mr. Ron Gibbins.

The survey property is located in the Omineca Mining District around the Village of Manson Creek as shown in Figure 1. A gravel road crosses the property from east to west. The claims, covered wholly or partly by the present survey, are listed on the title page of the report and are shown on Plate 6 (scale 1" = 3000').

DESCRIPTION OF METHOD AND INSTRUMENTATION

A Scintrex Mark VII 2.5 kw time-domain induced polarization unit was utilized on the present survey. This unit has a current "on" time of 2.0 seconds and current "off" (potential measuring time) of 2.0 seconds. The polarization/transient voltages are integrated between the .45 to 1.1 second part of the "off" cycle and normalized to the "on" cycle voltage at the receiver. The resulting Chargeability, in milliseconds, is a measure of the induced polarization effect. The Resistivity, in ohm-meters, of the rocks in the measurement zone is computed from the formula $R = CV_p/I$ where V_p = "on" cycle voltage at the receiver, I = current output from the transmitter; C = a constant depending on the array geometry.

For the present survey the Three Electrode Array was utilized. This array is shown schematically below in Figure 2.

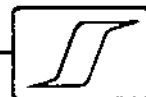
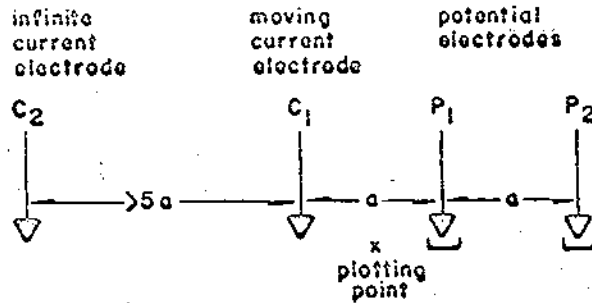

FIG. 2. THREE ELECTRODE ARRAY



Potential or "a" spacings of 200 feet and 400 feet were employed throughout for reconnaissance purposes. Readings were taken at intervals of 200 feet. Additional detailed coverage was undertaken over zones of interest utilizing "a" spacings of 50 and 100 feet. The plotting point for the Three Electrode Array is taken as the midpoint between the C₁ and P₁ electrodes (see Figure 2). Topographic variations and geological inhomogeneities may result in the centre of the anomalous zone being shifted from its apparent location using this midpoint convention.

Induced polarization responses may arise from metallic or non-metallic agencies. The former include most sulphides (except sphalerite), arsenides, a few oxides such as magnetite and, unfortunately, graphite. Non-metallic sources include alteration minerals such as sericite, chlorite, serpentine and some clay minerals. There is no reliable criterion for differentiating between over-voltage responses from metallic or non-metallic minerals or for distinguishing between the responses of one type of sulphide and another.

A more detailed description of the induced polarization method is contained in the attached copy of Dr. H. O. Seigel's paper entitled "Induced Polarization Method" dated 1970.



THE SURVEY GRID

The survey grid consisted of a 13,400' base line striking (magnetic) north. Sixteen grid lines were laid out at 800 foot intervals to the west of, and perpendicular to, this base line (Plate 6). These lines were numbered L-16 N to L-150 N. A total of 14.6 line miles of induced polarization coverage were attained.

GEOLOGY

The writers are not familiar with the local geology of the property.

The regional geology is shown on G.S.C. Map 971A Smithers-Fort St. James, British Columbia on the scale of 1 inch = 8 miles. Volcanics and sediments of the Cache Creek Group are believed to underly the entire grid area.

The purpose of the present survey was to map the subsurface distribution of metallicly conducting mineralization.

PRESENTATION OF RESULTS

Plates 1 and 2 show the chargeability and resistivity data, respectively, in profile form. The horizontal scale is 1" = 400' and the vertical scales are 1" = 10.0 milliseconds for chargeability and 2" = 1 logarithmic cycle for the resistivity (base level = 10 ohm-meters).

Plates 3 and 4 show the chargeability and resistivity data, respectively, in contour plan on a base scale of 1" = 400'. The contour intervals are 10.0 milliseconds for the chargeability and logarithmic for the resistivity.

Plate 5 contains profiles of the detail geophysical data. The horizontal scale is 1" = 100'; the vertical scales are as on Plates 1 and 2.



DISCUSSION OF RESULTS

As indicated on Plate 4 (the Resistivity Contour Plan) the Manson Creek property can be divided into a number of distinct regions on the basis of their resistivity signatures. Areas exhibiting resistivities of more than 100 ohm-meters are darkly shaded; those showing resistivities of less than 8 ohm-meters are lightly shaded. The resistivity 'highs' (dark areas) are designated A, B, C and D; their presumed boundaries are demarcated. Some cross structures (likely fault zones) are indicated.

Region A is a prominent 'high' extending north-northwest across the property from L-40 N to L-136 N inclusive. It has a strike length of approximately 10,000' and a width of about 600'. It abutts onto a prominent fault (or contact zone) on L-32 N and is open grid north off L-136 N. It coincides with a zone of low chargeability (see Plate 3).

Regions, B, C, and D show a similar high resistivity - low chargeability combination. B extends across L-16 N and L-24 N - it is open grid south. C lies along the extreme west end of L-104 N to L - 136 N inclusive; D on the extreme east ends of L-99 N and L-104 N. Surrounding the above highs there is a 'sea of low relief' where resistivities in excess of 8 ohm-meters are rare.

The average background chargeability observed within the property ranges from about 2.0 to 10.0 milliseconds. In general, areas of low chargeability coincide with zones of high resistivity (an exception being the L-48 N to L-72 N inclusive data).

The chargeability contour plan has been divided into four zones of anomalous response designated 1 - 4 inclusive. These regions are discussed in turn below.



Zone 1 - is an extensive area of high chargeability extending across the western half of L-88 N to L-120 N inclusive. It covers an area approximately 2800' X 4800' and is open grid south. Peak amplitudes were observed as follows:

L-96 N; 58 W 70.0 milliseconds - (a = 400')

L-96 N; 61 W 77.5 milliseconds - (a = 200')

L-112 N; 59 W 73.0 milliseconds - (a = 200')

Detailed induced polarization coverage carried out on L-120 N (43 W to 63 W - see Plate 5) suggests that Zone 1 reflects a banded polarizing source dipping grid west and coming to within less than about 20' of the ground surface in the vicinity of Stations 47 + 75 W and to within less than about 30' of the ground surface in the vicinity of Station 52 + 50 W. It could be caused by 5 - 10% by volume of disseminated metallicly conducting mineralization (metallic sulphides or graphite). The resistivity of the overburden is relatively high, its chargeability relatively low. Bedrock resistivities are extremely low.

Zone 2 - trends about 50° W across L-88 N to L-136 N. It consists of four elongated zones (dark shading), each 300' wide and more than 800' long, strung out parallel to, and coincident with, the east boundary of resistivity Area A and probably reflecting metallicly conducting mineralization lying on a geological contact.

Peak responses were observed at the following locations:

L-88 N; 23 W 59.0 milliseconds - (a = 200')

L-88 N; 24 W 45.0 milliseconds - (a = 400')

L-120 N; 37 W 81.5 milliseconds - (a = 400')

L-120 N; 38 W 65.0 milliseconds - (a = 400')

L-136 N; 35 W 75.0 milliseconds - (a = 200')

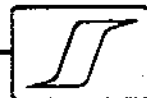

L-136 N; 36 W; 77.0 milliseconds - (a = 400')

The indicated dip of the polarizing material is grid west. The response parameters suggest 6 - 8% by volume of disseminated polarizing material coming to within less than about 25' of the ground surface below the regions of peak response. Such material could be metallic sulphides or graphite.

Zone 2 appears to be truncated at several points by strong cross-faulting.

A few minor zones of anomalous chargeability lie grid east of Zone 2 (note the peak responses at 22 W L-136 N, 20 W L-128 N, etc.).

Zone 3 - is located on L-3 N, L-40 N and L-48 N. It is triangular in shape - 1500' wide on L-32 N, 300' wide on L-48 N. It abutts, grid south, onto a prominent fault or contact zone and it coincides with an area of low resistivity.

Peak responses were observed as follows:

L-32 N; 33 W 56.0 milliseconds - (a = 400')

L-40 N; 33 W 57.0 milliseconds - (a = 200')

The polarizing material appears to be confined close to surface on L-40 N. On L-32 N, however, it seems to extend from surface to depth where it is possibly concentrated close to, or along, a fault or contact zone. Anomaly 3 could reflect 5 - 6% by volume of disseminated metallicly conducting material coming to within less than 50' of the ground surface in the vicinity of the peak responses listed above.

Zone 4 - is located about 600' due north of 3. It extends across L-40 N to 64-N inclusive and, like 3, abutts grid south onto a major cross structure (see Plate 3). A peak amplitude was observed at

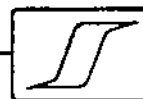

the following location:

L-40 N; 15 W - 77.0 milliseconds - (a = 200')

On L-40 N the maximum contribution to the response appears to come from within about 100' of the ground surface. On L-56 N the source appears to extend from near surface to a considerable depth. Zone 4 could reflect 6 - 8% by volume of disseminated metallicly conducting material likely dipping grid west.

Several other anomalous areas of residual interest were indicated by the survey. Note, for example, the chargeability 'highs' on L-104 N at 80 W (55.0 milliseconds for a = 400') and on L-120 N at Station 79 W.

CONCLUSIONS AND RECOMMENDATIONS

On the basis of its geo-electric characteristics the Manson Creek property appears to contain a series of parallel formations striking about N 50° W. Several of these (A, B, C and D on Plate 4) are relatively resistive - the remainder (the lightly shaded areas on Plate 4) are relatively conductive. Strong cross structures striking about N 25° E (presumably fault zones) are present.

Several zones of anomalous chargeability were observed on the property. These zones tend to lie in areas of low resistivity or close to formation boundaries. They also appear to be delimited by faulting (compare Plates 2, 3 and 4). They could reflect 6-8% by volume of disseminated metallicly conducting mineralization (sulphides or graphite) coming to within less than about 20' of the ground surface below the areas of peak response.

All of the anomalous zones, on the basis of their amplitude and shape characteristics, warrant further exploratory attention. It is



recommended that they be carefully correlated with the known geology, geochemistry and mineral occurrences of the grid area. If drilling is warranted suitable holes may be collared as follows:

- DDH #1 - Collar at 48 + 25 W; L-120 N drill grid east at 45° for a distance of 400'.
- DDH #2 - Collar at 51 W; L-120 N drill grid east at 45° for a distance of 500'.
- DDH #3 - Collar at 62 W; L-96 N drill grid east at 45° for a distance of 500'.
- DDH #4 - Collar at 56 W; L-96 N drill grid west at 45° for a distance of 500'.
- DDH #5 - Collar at 38 W; L-136 N drill grid east at 45° for a distance of 500'.
- DDH #6 - Collar at 34 W; L-32 N drill grid east at 45° for a distance of 500'.
- DDH #7 - Collar at 20 W; L-40 N drill grid east at 45° for a distance of 500'.

Additional drilling and/or geophysical coverage would be predicated upon the results of the above minimum programme.

Respectfully submitted,
SCINTREX SURVEYS LIMITED

Michael J. Lewis, M.Sc.
Geophysicist



Peter J. Fominoff, B.A.Sc., P.Eng.
Geophysicist



Vancouver, B. C.
October 27, 1972



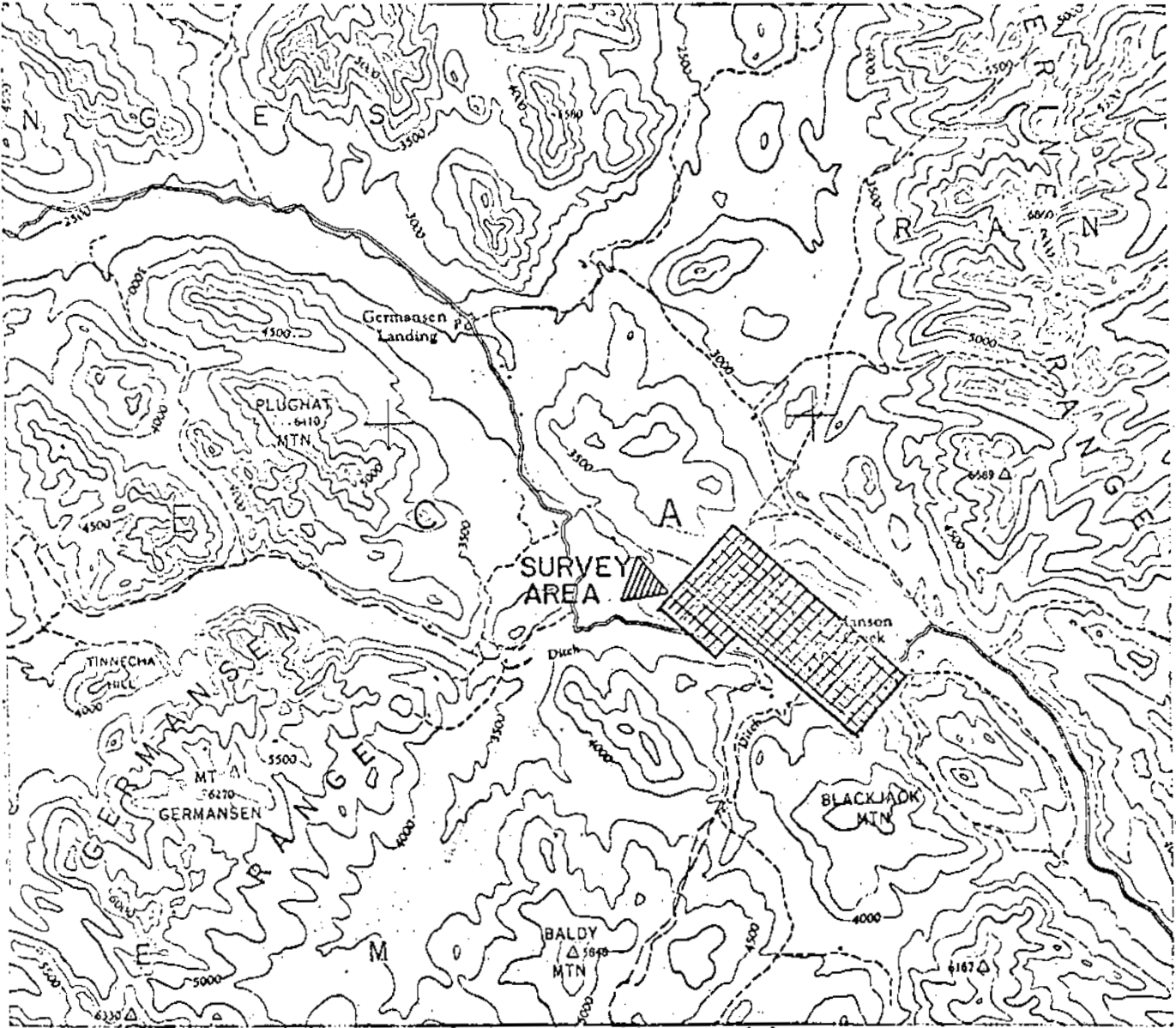

4246 M-1

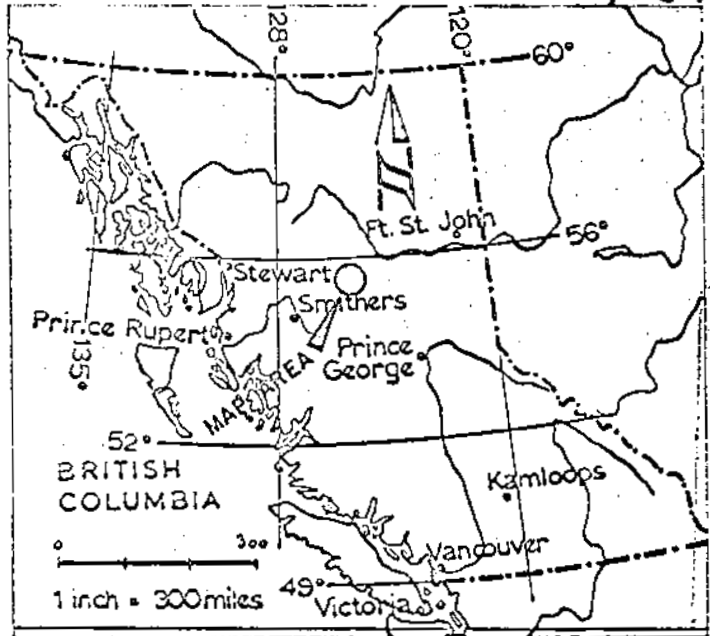

SULLIVAN AND RODGERS

PROFESSIONAL
 PROVINCE OF
 PETER J. FOMANOFF
 SURVEYOR
 COLUMBIA
 ENGINEER

LOCATION MAP

MANSON, CREEK AREA, BC.

SCALE 1 : 250,000 (M)

4miles 0 4miles

Survey by
 SCINTREX SURVEYS LTD.
 SEPT. 1972

FIG. 1

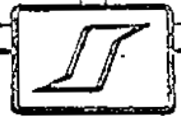

Department of
Mines and Petroleum Resources
ASSESSMENT REPORT

NO. 4246 MAP #1

TO GERMANSEN
LANDING

BL

144	142	140	119	120
143	141	139	117	118
148	146	138	115	116
147	145	137	113	114
152	150	136	111	112
151	149	135	109	110
		134	107	108
		133	105	106
		132	103	104
		131	101	102

C.M. & S.
CAMPSITE

- L-150
- L-136
- L-128
- L-120
- L-112
- L-104
- L-96
- L-88
- L-72
- L-64
- L-56
- L-48
- L-40
- L-32
- L-24
- L-16
- L-0+00

SURVEYED SECTION OF
"IDA" CLAIM GROUP 1 to 152

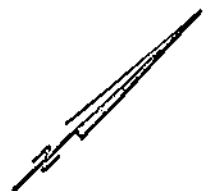

PLATE 6

SULLIVAN AND RODGERS
MANSON CREEK AREA, BC.

Department of
Mines and Petroleum Resources
ASSESSMENT REPORT
NO. **4246** MAP # **7**

SURVEY GRID AND CLAIM LOCATION MAP

SCALE 1" = 3000'

Rev. J.

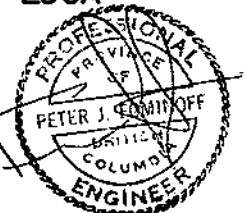

SURVEY BY SCINTREX SURVEYS LIMITED
SEPTEMBER 1972

Induced polarisation method

By Dr. HAROLD O. SEIGEL
President, Scintrex Limited

REPRINTED FROM THE **MINING**
OCTOBER 1970 ISSUE OF... **IN CANADA**

for
 **SCINTREX**

The induced polarization method is based on the electrochemical phenomenon of Overvoltage, that is, on the establishment and detection of double layers of electrical charge at the interface between ionic and electronic conducting material when an electrical current is caused to pass across the interface.

In practice, two different field techniques (Time Domain and Frequency Domain) have been employed to execute surveys with this method. These techniques can yield essentially equivalent information but do not always do so. Instrumentation and field procedures using both techniques have evolved considerably over the past two decades. Much theoretical information for quantitative interpretation has been accumulated.

All naturally occurring sulphides of metallic lustre, some oxides and graphite, give marked induced polarization responses when present in sufficient volume, even when such materials occur in low concentrations and in the form of discrete, non-interconnected particles.

Induced Polarization is the only method presently available which has general application to the direct detection of disseminated sulphide deposits such as "porphyry type" or bedded copper deposits, and bedded lead-zinc deposits in carbonate rocks.

A number of case histories are documented where standard geoelectrical and other geophysical

methods failed to yield an indication of sulphide mineralization detectable by the induced polarization method.

Each rock and soil type exhibits appreciable induced polarization response, usually confined to a relatively low amplitude range, which is characteristic of the specific rock or soil. Certain clays and platy minerals including serpentine, sericite and chlorite, sometimes give rise to abnormally high responses. These effects are attributed largely to so-called "membrane" polarizations.

Despite a moderate amount of laboratory and field investigation, it is not feasible in general to differentiate between induced polarization responses due to Overvoltage and non-metallic sources, nor to differentiate between possible sources within each group.

Because of other variables, it is likewise difficult to uniquely equate a specific induced polarization response to a specific percentage of metallic content, although mean relationships have been established.

Through the measurement of secondary parameters, such as the transient decay curve form characteristics, one may obtain useful information relating to the average particle size of metallic responsive bodies or to the influence of electromagnetic transients on the I.P. measurements. The latter effect becomes prominent when surveys are made in areas with highly conducting surface materials, e.g. semi-arid regions.

Induced polarisation method

By Dr. HAROLD O. SEIGEL
President, Scintrex Limited

THE induced polarization (or I.P. as it is commonly known) method is, in application, the newest of our mining geophysical tools, having come into active use only in late 1948. Its roots extend somewhat farther back, however. Schlumberger (1920) reports having noted a relatively lengthy decay of the residual voltages in the vicinity of a sulphide body after the interruption of a primary D.C. current. Unfortunately, measurements in non-mineralized areas gave rise to rather similar residual polarization potentials, so he apparently abandoned his efforts.

In the late 1930's in the U.S.S.R. (Dakhnov, 1941) I.P. measurements were being made in petroleum well logging in an attempt to obtain information relating to the fluid permeability of the formations traversed by the well. Dakhnov mentions the possible application of the method to the exploration for sulphide mineralization, although it would appear that no such use was being made use thereof at that time. Unfortunately the volume of Dakhnov did not come to the attention of abstracters in North America until the spring of 1950.

Active development of the I.P. method as applied to mineral exploration in North America commenced with the writer's theoretical study in 1947 of the phenomenon of Overvoltage and his report (Seigel, 1948) on its possible application to geophysical prospecting. Laboratory and subsequent field investigation, sponsored by Newmont Mining Corporation in 1948 eventually led to the development of a working field technique and the recognition of polarization effects in all rocks (Seigel 1949).

Contemporaneously and independently D.A. Bleil (Bleil 1953) indicated the possibility of utilizing

I.P. in prospecting for magnetite and sulphide mineralization but apparently did not recognize the presence of non-metallic polarization effects in rocks.

Until 1950 all I.P. measurements were of the "time-domain" type (see below). In 1950, as the result of some laboratory measurements, L.S. Collett and the writer suggested the method of measuring I.P. effects using sinusoidal current forms of different frequencies. J.R. Wait expanded greatly on the possibilities of this approach and successful field tests were carried out in that year. The work of the Newmont group is summarized in a monograph (Wait 1959).

Since 1950 several groups have been active in the development of the I.P. method by means of theoretical laboratory model and field studies. Prominent among these groups has been that at the Massachusetts Institute of Technology (Hall of 1957) (Madden 1957) (Marshall 1959).

Within the literal meaning of the term, polarization is a separation of charge to form an effective dipolar distribution within a medium. Induced polarization is, therefore, a separation of charge which is due to an applied electric field. It may also include phenomena which cause voltage distributions similar to those due to true polarization effects.

For practical purposes, only polarization effects with time constants of build up and decay longer than a few milliseconds are of importance. This usually excludes such phenomena as dielectric polarization and others which are encompassed by the normal electromagnetic equations.

In order to measure I.P. effects in a volume of rock one passes current through the volume by means of two contact points or electrodes and

measures existing voltages across two other contact points.

Theoretically, any time varying current form can be used, but in practice only two such forms are employed. In the first technique a steady current is passed for a period of from one second to several tens of seconds and then abruptly interrupted.

The polarization voltages built up during the passage of the current will decay slowly after the interception of the current and will be visible for at least several seconds after the interception. This is termed the "Time Domain" method.

The "Frequency Domain" method entails the passage of sine wave current forms of two or more low, but well separated, frequencies, e.g. 0.1 and 2.5 c.p.s., or 0.5 c.p.s. and 10 c.p.s.

Since polarization effects take an appreciable time to build up, it can be seen that they will be larger at the lower frequency than at the higher, so that apparent resistivities or transfer impedances between the current and measuring circuits will be larger at the lower frequency. The change of measured resistivities with frequency is, therefore, an indication of polarization effects.

Further discussion of the precise quantities measured in the Time and Frequency Domain methods will be resumed after a presentation of some of the polarization phenomena involved.

When a metal electrode is immersed in a solution of ions of a certain concentration and valence, a potential difference is established between the metal and the solution sides of the interface. This difference in potential is an explicit function of the ion concentration and valence, etc.

When an external voltage is applied across the interface a current is caused to flow and the potential drop across the interface changes from its initial

value. If the electrode is a cathode it becomes more negative with respect to the solution, whereas if it is an anode, it becomes more positive with respect to the solution.

The change in interface voltage is called the "Overvoltage" or "Polarization Potential" of the electrode. If the electrode is a cathode, we speak of "Hydrogen Overvoltage" and, if an anode, of "Oxygen Overvoltage".

These Overvoltages are due to an accumulation of ions on the electrolyte side of the interface, waiting to be discharged. The charge of these ions will be balanced by an equal opposite charge due to electrons or protons on the electrode side of the interface.

For small current densities the Overvoltage is proportional to the current density, i.e. is a linear phenomenon. The variation of Overvoltage with several other factors is presented in the writer's Doctoral Thesis. (Seigel, 1949). The time constant of build up and decay is of the order of several tenths of seconds.

Overvoltage is, therefore, established whenever current is caused to flow across an interface between ionic and electronic conduction. In normal rocks the current which flows under the action of an impressed E.M.F. does so by virtue of ionic conduction in the electrolyte in the capillaries of the rock.

There are, however, certain rock forming minerals which have a measure of electronic conduction, and these include almost all the metallic sulphides (except sphalerite), graphite, some coals, some oxides such as magnetite, and pyrolusite, native metals and some arsenides and other minerals with a metallic lustre.

When these are present in a rock subjected to an impressed E.M.F., current will be caused to flow across capillary - mineral interfaces and

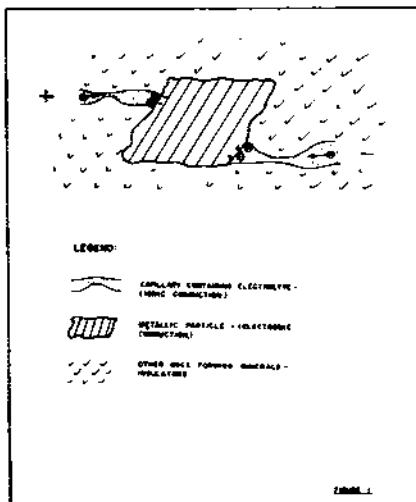

Induced Polarization Response of a Metallic Conducting Particle in a Rock.

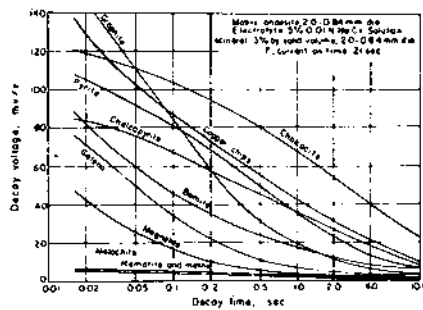

FIGURE 2

Decay Curves for Metallic and Non-metallic Minerals (after Wait, 1959).

hydrogen and oxygen Overvoltages will be established. Figure 1 is a simplified representation of what happens to an electronic conducting particle in a rock under the influence of current flow.

Despite attempts by various workers to investigate the source of non-metallic I.P. in rocks, an adequate explanation of all observed effects is still lacking. A number of possible contributory agents have been established. Vacquier (Vacquier et al, 1957) has carefully examined strong polarization effects due to certain types of clay minerals.

These effects he believed to be related to electro dialysis of the clay particles. This is only one type of phenomenon which can cause "ion-sorting" or "membrane effects".

For example, a cation selective membrane zone may exist in which the mobility of the cation is increased relative to that of the anion, causing ionic concentration gradients and, therefore, polarization effects (see also Marshall, 1959). Much work remains to be done to determine the various agencies, other than clay particles, which can cause such membrane effects.

Time Domain Method: Figure 2 shows the typical transient I.P. voltage decay forms for various rock forming materials in a laboratory testing apparatus. See also Scott (1969). A primary current time of the order of 21 seconds was employed on these tests.

It will be noted that the voltages are plotted against the logarithm of the decay time and are approximate linear functions of the log t for reasonable lengths of time (t). The amplitude of the transient voltages has been normalized with respect to the steady state voltage existing immediately before the interception of the primary current.

In order to indicate the magnitude of the I.P. effects one may measure one or more characteristics of the transient decay curve and relate it back to the amplitude of the measured

primary steady state voltage prior to the interception of the primary current.

It may be shown that the ratio is V_s/V_p , i.e. peak polarization voltage to the primary voltage just before interception is a physical property of the medium, which has been called the "Chargeability" of the medium.

Since it has been demonstrated that most I.P. decay voltages are similar in form but differ in amplitude (for the same charging time) one can take the average of several transient voltages at different times, or indeed use the time integral of the transient voltages as a diagnostic criterion. The advantage of averaging or integrating lies in the suppression of earth noises and of electromagnetic coupling effects.

The chargeability is often designated by the letter "M". If the time integral is used the units of M will be in millivolt seconds/volt or milli-seconds. If one or more transient voltage values are measured and normalized, M will be dimensionless.

For homogeneous, isotropic material, the value of M is independent of the shape or size of the volume tested and of the location of the electrodes on it. It is a true physical property. For a given medium it is dependent on the current charging time and on the precise parameter of the decay curve measured. There are also subsidiary variations with temperatures and electrolyte content, etc.

Frequency Variation Method: Figure 3 shows typical curves of the variation of normalized resistivities with frequency for various sulphide, graphite and non-metallic rock minerals in artificial mixtures. Both the fact of the variation of apparent resistivity with frequency and the presence of phase angle lags may be used to indicate the presence of I.P. effects, although generally only the first is so employed.

Since the I.P. phenomena may be shown to be linear, within the usual range of voltages and currents, there is

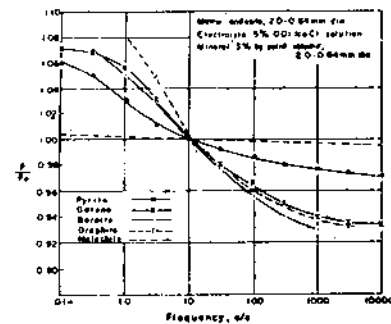
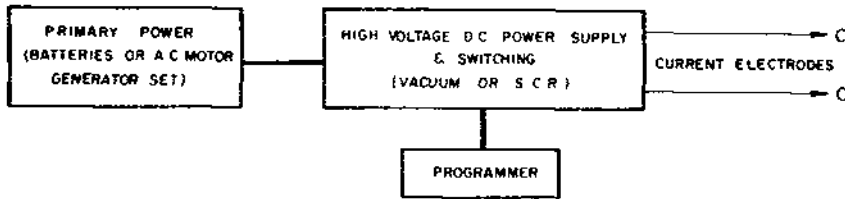

FIGURE 3

Resistivity-frequency Characteristics of Metallic and Non-metallic Minerals (after Wait, 1959).

TRANSMITTER



RECEIVER



WAVE FORMS

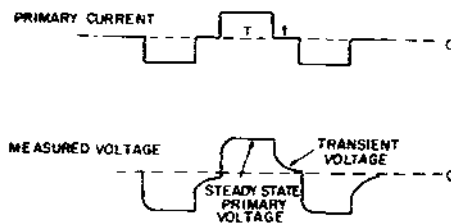

FIGURE 4

Time Domain Apparatus, Block Diagram and Wave Forms.

a direct relationship between the transient curve form and the variation of apparent resistivity with frequency. To arrive at a dimensionless parameter equivalent to the chargeability, one would have to normalize the apparent resistivity, by dividing by the resistivity at one particular frequency. The factor used is called the "Percent Frequency Effect" or P.F.E. and is defined as $(R_1 - R_2 / R_1) \times 100$ where R_1 and R_2 are the apparent resistivities at the lower and higher frequencies used (Marshall, 1959).

A second parameter is sometimes employed which is really a mixture of physical properties. It is called the Metal Factor (M.F.) and is proportional to P.F.E./ R_2 or to M/R . As such, it serves to emphasize I.P. effects which occur in obviously conductive environments, i.e. concentrated sulphide deposits or sulphides and graphite in shear zones.

Since it is not a dimensionless factor nor a true single physical property, it is subject to variation related to the changes of shape and resistivity of the medium under investigation, rather than simply to variations in polarization characteristics.

In my opinion, the metal factor has some merit in emphasizing I.P. anomalies due to concentrated metallic bodies, but should not be used as a primary indicator of abnormal I.P. conditions.

Figure 4 shows a block diagram of apparatus commonly used in field operations with the time-domain method and the primary current and resultant voltage wave forms. The transient voltage amplitudes are considerably exaggerated to be visible.

Power sources up to 30 K.V.A., 5000 volts and 20 amperes have been employed where extreme penetration is desired in low resistivity areas. The current-on time T ranges from one

second to as much as 30 seconds, and the current-off time t may be as much as 10 seconds. It is not strictly necessary to employ a cyclic current wave form, but considerable advantages in signal-to-noise ratio are achieved thereby.

Most of the receivers now employed are remote triggering, i.e. they are internally programmed, triggered by the primary voltage pulse and do not require a cable interconnection to the cycle timer on the power control unit. Figure 5a shows a typical time-domain remote-triggered receiver (Scintrex MK VII, Newmont-Type). This particular receiver has several interesting features.

For one, there is a memory circuit which provides an automatic self potential adjustment at the tail end of each cycle. For another, it has the ability to integrate the area either below the transient curve (standard M measurement) or above the transient curve (denoted as the L measurement) over a specific time interval. The ratio of these quantities gives a direct

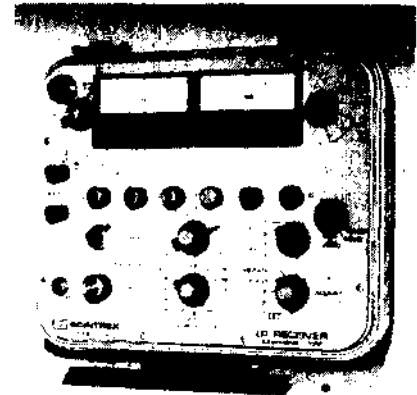

Typical Modern Time Domain I.P. Receiver (Scintrex Mk. VII)

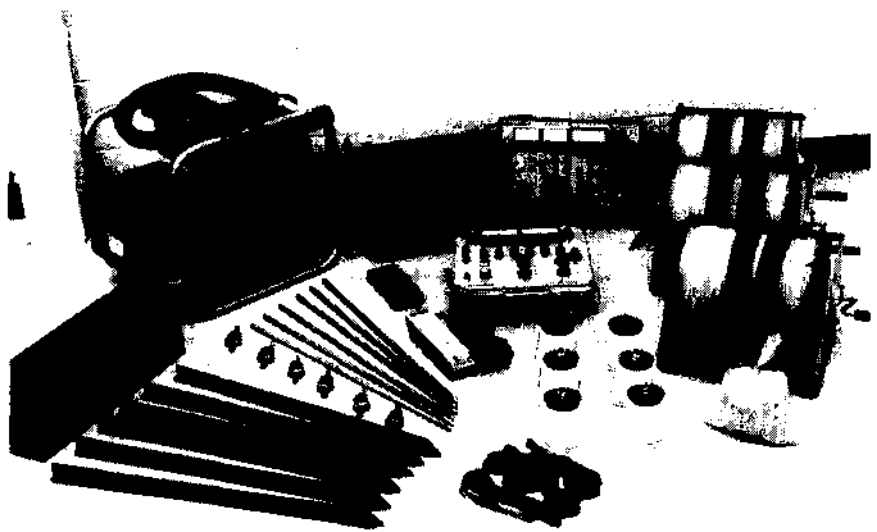

FIGURE 5b

Typical Modern Time Domain I.P. Unit (Scintrex Mk VII)

Array	Domain Employed	Advantages	Disadvantages
Wenner	Time	For local vertical profiling.	Poor depth penetration. Requires four linemen.
Three Electrode (or Pole-Dipole)	Time and Frequency	Three linemen. Universal coupling. Good depth penetration.	Susceptible to surface masking effects.
Dipole-Dipole	Frequency	Good resolution. Universal coupling.	Complex curve forms. Low order signals. Susceptible to surface masking effects.
Gradient	Time	Minimum masking. Two linemen only. Excellent depth penetration. Excellent resolution. Can use multiple receivers for speed.	Couples best with steeply dipping bodies. Low order signals.

measure of the decay curve form, which may be of diagnostic value (see below). In areas of low electric earth noise useful measurements may be made with primary voltages as low as 300 microvolts. Figure 5b shows a complete typical modern time domain induced polarization unit (Scintrex MkVII) of which the Newmont-type receiver above is a part.

Figure 6 shows a block diagram of a typical frequency domain field apparatus and voltage wave form. Since the primary current and earth voltages are usually measured by

separate devices and their ratio employed to obtain the apparent earth resistivity and its variation with frequency, it is common practice to adjust the current to a standard value and maintain it there to the required accuracy.

The primary wave form is usually a commutated D.C. Commonly, up to 6 frequencies are available in the range of 0.05 to 10 c.p.s. Figure 7 shows a typical modern frequency domain measuring unit. This unit has a high degree of power line frequency (50 c.p.s. to 60 c.p.s.) rejection.

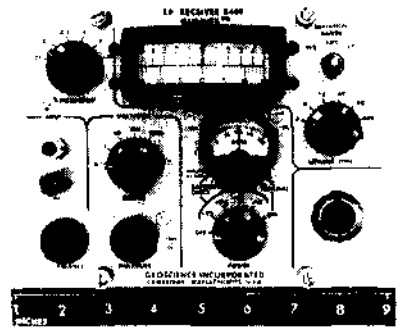

Typical Modern Frequency Domain Receiver (Geoscience).

It measures both the primary voltage and the change of primary voltage with change in operating frequency, the latter to an accuracy of about $\pm 0.3\%$ when the former exceeds 100 microvolts. It has the added feature of a phase lock voltmeter which assists in making measurements under low signal-to-noise conditions.

Common field electrode arrays are shown in Figure 8. The electrodes marked C are current electrodes and those marked P are potential or measuring electrodes. Each of the electrode arrays has its own advantages and disadvantages in respect of depth of penetration, labour requirements for moving, susceptibility to earth noise, electromagnetic earth transients and interline coupling. The following table summarizes the features of these arrays.

For each array (except the gradient array) the basic electrode spacing "a" is selected to give adequate penetration down to the desired depth of exploration. For the pole-dipole and double dipole it is customary to obtain several profiles for different values of "a" or for integral values of n from 1 to as much as 4.

For the symmetric arrays (Wenner and Dipole-Dipole) the measured values are plotted against the midpoint of the array. When using the Three Electrode Array (time-domain) the station position is taken to be the midpoint of the moving current and the nearest potential electrode. When using the Pole-Dipole (frequency domain) the station position is taken as the midpoint between the moving current electrode and the midpoint of the two potential electrodes.

With the Gradient array it is the midpoint of the two potential electrodes. For the Three Electrode array and Pole-Dipole these station locations are not unique and represent conventions only.

I.P. data may be plotted in profile form or contoured, although it should be noted that somewhat different results will be obtained with different line orientations so that contouring is

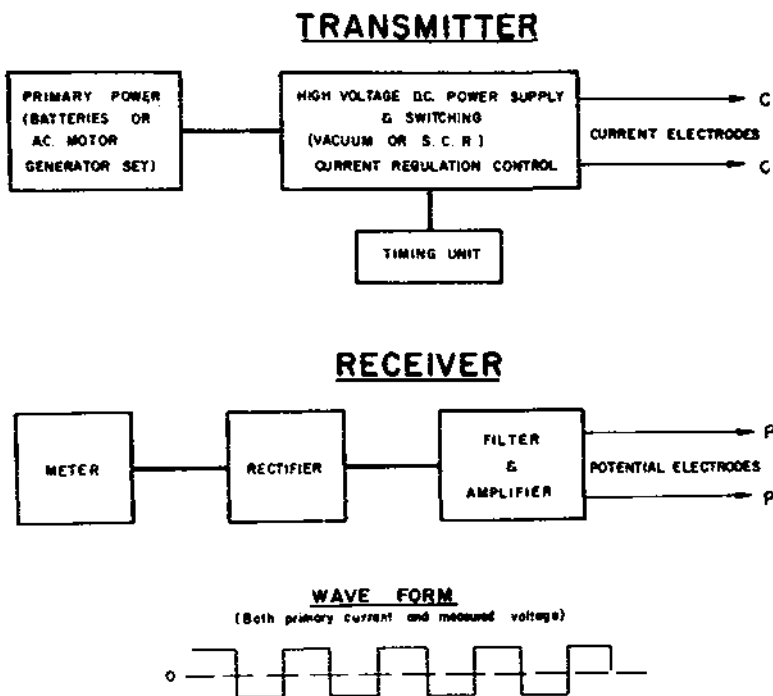

Frequency Domain Apparatus, Block Diagram and Wave Forms.

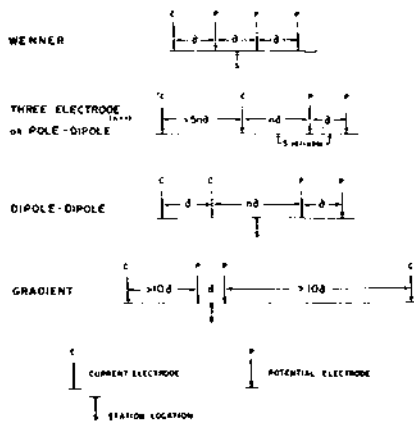

Common Field Electrode Arrays.

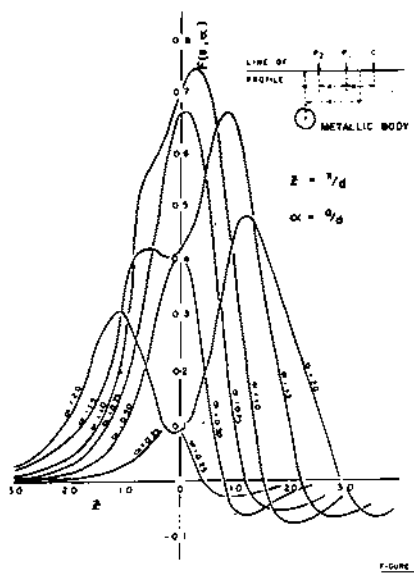

Theoretical Response of a Sphere, Three Electrode Array.

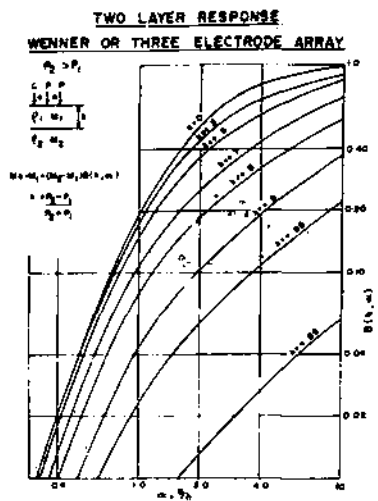

Theoretical Response of Two Layer Earth, Wenner or Three Electrode Array.

not strictly justified. Profile interpretation is superior, particularly for shallow, confined bodies, because multiple peaked curves may arise from such bodies using certain electrode arrays, and the plotted peaks may give an erroneous impression of the location of the polarizable body.

To obtain the variation of physical properties with depth, expanding arrays may be used with any of the electrode systems, keeping the spread centre fixed and simply changing the relative spacing "a". This is of particular value where it is known or expected that vertical variations of physical properties will be much greater than lateral variations.

As the spacing is increased the influence of the deeper regions becomes more significant, and the resultant resistivity and I.P. curves may often be interpreted to give the depth to discontinuities in physical properties and the physical properties themselves.

Common practice in presenting frequency domain results is to plot the measured data below the line at a depth equal to the distance of the station position (as defined above) from the midpoint of the potential dipole. When this is done for a variety of values of "n" a pseudo two-dimensional section, results which show, albeit in a markedly distorted fashion, the variation of physical properties with depth.

A mathematical representation of I.P. effects has been developed by the writer (Seigel, 1959), which relates the observed I.P. response of a heterogeneous medium to the distribution of resistivities and I.P. characteristics. To a first approximation it is equally applicable to any I.P. parameter measured in the time and frequency domains.

From this theory, one may predict the anomalous response to be

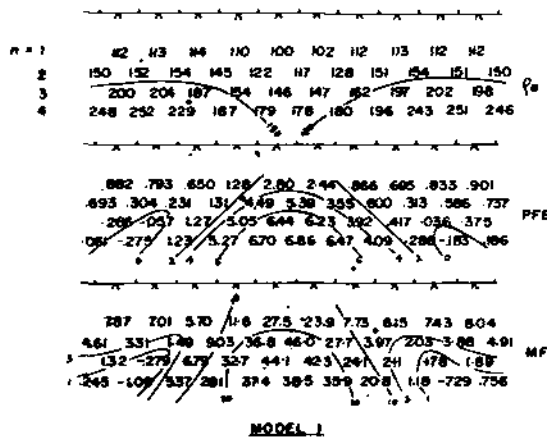

Model Response of a Dike, Dipole-Dipole Array (courtesy K. Vozoff).

expected from a specific body with a given chargeability and resistivity contrast. For example, Figure 9, shows the form factor F plotted for the Three Electrode Array for a sphere for various values of λ , where λ is the ratio of the electrode spacing to the depth to the centre of the sphere. The sphere response is proportional to F times the chargeability contrast, times its volume and times a resistivity-ratio factor. A number of such theoretical curves, for the pole-dipole and gradient arrays, using spheres and ellipsoids as models, may be seen in the paper by Dieter (1969) et al.

Curves of this sort permit one to interpret anomalies due to localized bodies. It will be seen that for each array there is an optimum spacing for a body at a particular depth, and, therefore, there is some meaning to the term "depth of penetration", except for the gradient array.

When the dimensions of the polarizable medium are large in comparison with its depth below surface, as is often the case, particularly in investigation of porphyry copper type deposits, a two layer approximation is adequate. Theoretical curves based on this approximation (Figure 10) may be used to interpret the results of expanding Wenner or Three Electrode array depth determinations.

For more complex geometries, mathematical solutions in closed form are often lacking. For such cases one may resort to model studies (e.g. Figure 11 for buried dike) or to computer calculated solutions.

The most productive use of the I.P. method to date has been in the exploration for deposits of metallically conducting minerals, where the amounts and degree of interconnection of these minerals are too low to give rise to an electromagnetically detectable body.

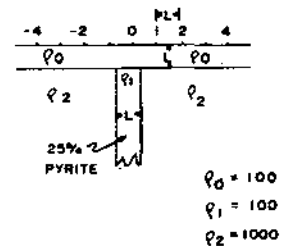
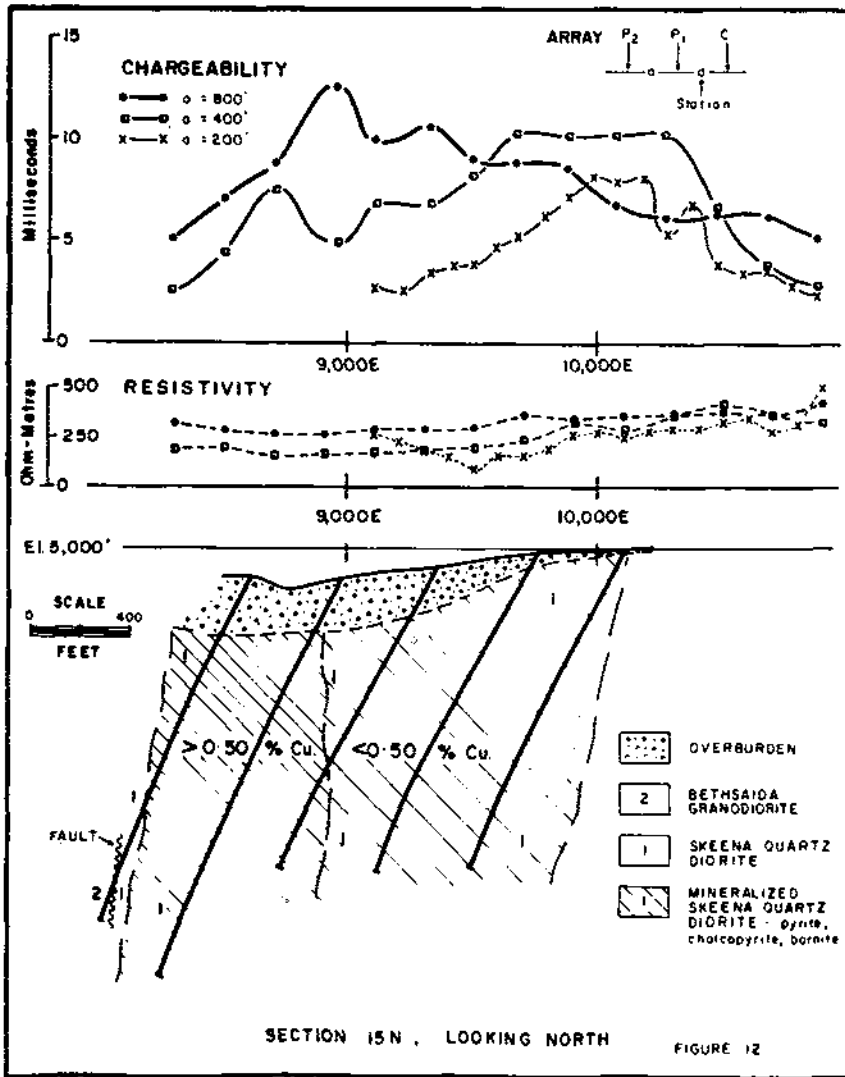
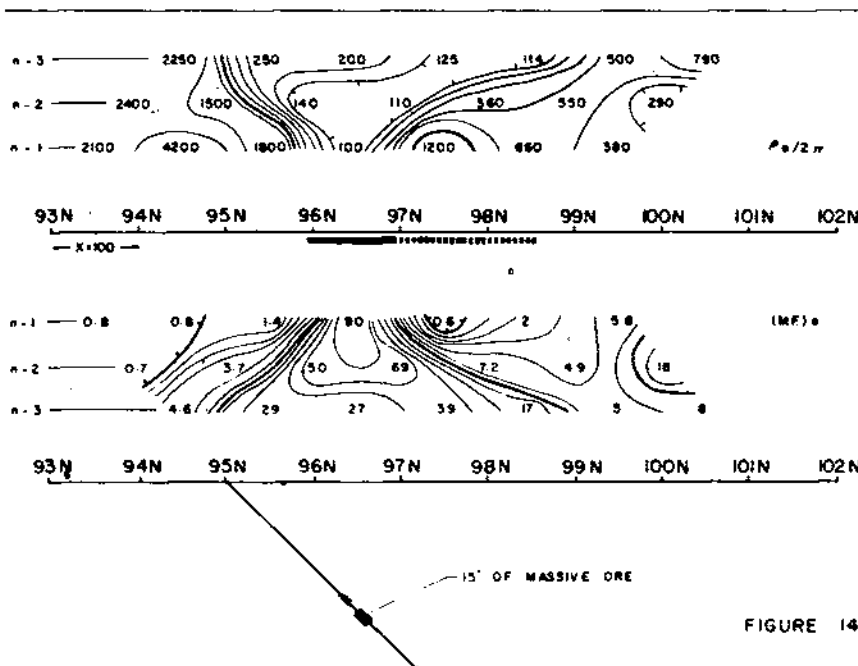

FIGURE 11



Geophysical and Drilling Results, Lornex Porphyry Copper Ore Body, British Columbia, Canada (courtesy Lornex Mining Corp. Ltd.)



Geophysical and Drilling Results Lead-Zinc-Copper Ore Body, Heath Steele Mine, New Brunswick, Canada (courtesy P. Hallof).

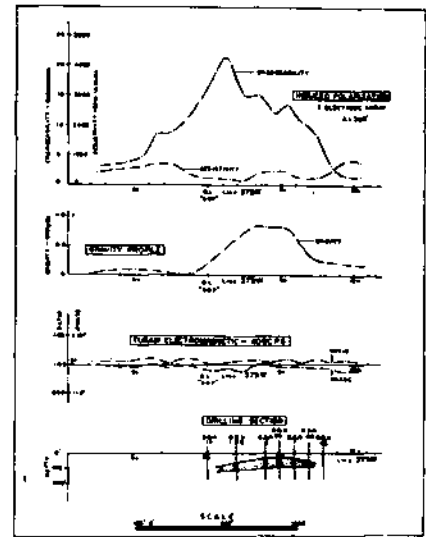

FIGURE 13

Geophysical and Drilling Results, Pyramid No. 1 Lead-Zinc Ore Body Pine Point Area, Northwest Territories, Canada (courtesy Pyramid Mines, Ltd.).

Where electromagnetic detection is feasible it is usually far more rapid and economical to apply electromagnetic induction methods to the problem. The I.P. method is the only geophysical tool available which is capable of direct detecting 1 percent or less by volume of metallic conducting sulphides.

It is best used, therefore, where there is a high ratio of economic minerals to total sulphide mineralization. Included in the proper I.P. range are such types of deposits as disseminated copper ores, in porphyry or bedded forms; lead-zinc deposits, particularly of the bedded type in carbonate rocks; gold and other deposits which have an association with disseminated metallic conductors. For many of these mineral occurrences the I.P. method is unique in providing detection.

Figure 12 shows time-domain discovery traverses over a typical newly discovered porphyry copper deposit in British Columbia. The lateral limits of the mineralization can be readily determined from the geophysical data, as well as the depth to the upper surface of the mineralization.

Figure 13 shows a discovery traverse over a major bedded body of sphalerite-galenamarcasite mineralization in carbonate rocks in the Pine Point area, Northwest Territories, Canada. For comparison purposes both gravity and Turam electromagnetic profiles on the same section are shown.

It is interesting to note that, despite an appreciable resistivity depression over the mineralization there is no significant Turam response at 400 c.p.s. The conductivity of the ore is, in fact, no higher than that of the surficial deposits in the general area, so that

electromagnetic and resistivity methods yield, in themselves, no useful information.

The gravity method, although yielding a positive response in this instance, does not provide a good reconnaissance tool in this area because of karst topography and other sources of changes in specific gravity.

One occasionally encounters a deposit of the "massive sulphide" type which is normally thought of as an electromagnetic type of target because of its high conducting sulphide content, but which, obviously because of the lack of large scale continuity of the conducting sulphides, does not respond to the electromagnetic techniques. Figure 14 shows an intersection of ore grade material of this type, in New Brunswick, Canada, where electromagnetic methods had yielded negative results.

In many types of ore deposits the bulk of the I.P. response is due to the accessory non-economic sulphides, usually pyrite and pyrrhotite, and the ore minerals themselves are in the minority. A true test of the sensitivity of the I.P. method is an example of a low grade disseminated deposit with no such accessory minerals. Figure 15 illustrates such a case, with an I.P. discovery section over the Gortdrum copper-silver-mercury deposit in Ireland. The ore minerals consist of chalcocite, bornite and chalcopyrite in a dolomitic limestone, and there is less than 2% average by volume of metallic conducting minerals.

Whereas the bulk of I.P. measurements in mineral exploration has, naturally, been made on surface, the technology of drill hole exploration has been well developed, particularly by the Newmont group (see Wagg, 1963). The time-domain method is suitable for drill hole applications since it permits a relatively close coupling of the current and potential lines in a small diameter bore hole.

The three electrode array has been extensively employed for logging purposes, with a variety of electrode spacings to give varying ranges of detection away from the hole. In this fashion the variation of electrical properties with distance from the hole may be determined. A second, "directional log" then gives information on the direction of any anomalous material indicated by the detection log.

Whereas the I.P. method is usually employed as a primary exploration tool it may play an auxiliary role as well, e.g. to distinguish between metallic and ionic conducting sources of other types of electrical anomalies, e.g. electromagnetic.

Figure 16 shows a typical conducting zone revealed by a ground

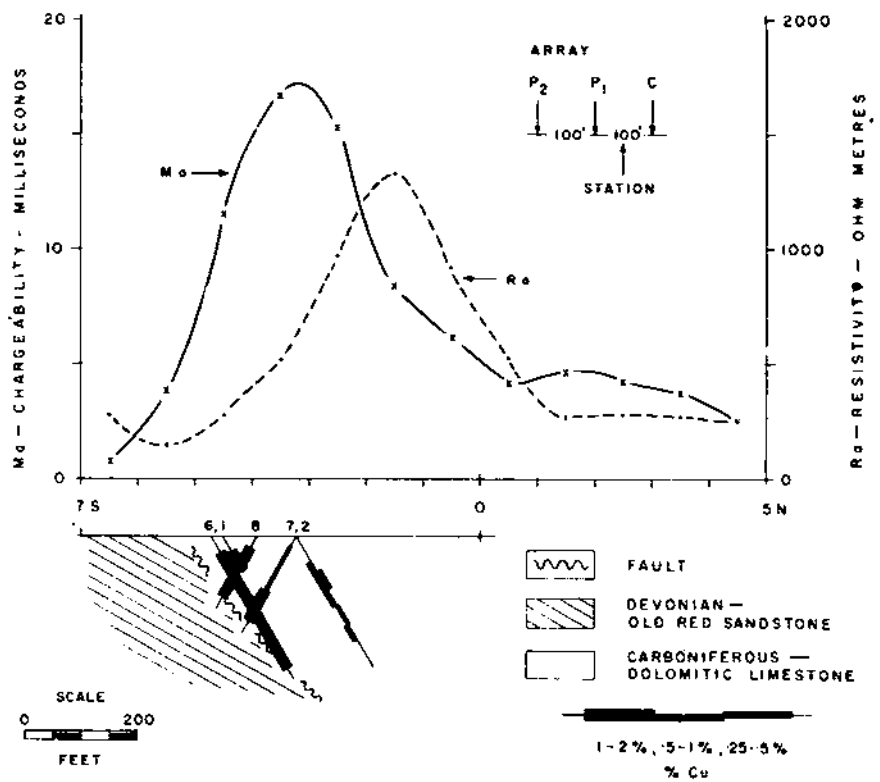

SECTION 200 E, FACING WEST
3 ELECTRODE ARRAY - a=100'

FIGURE 15

Geophysical and Drilling Results, Copper-Silver Ore Body, Gortdrum Mines, Ireland (courtesy Gortdrum Mines, Ltd.).

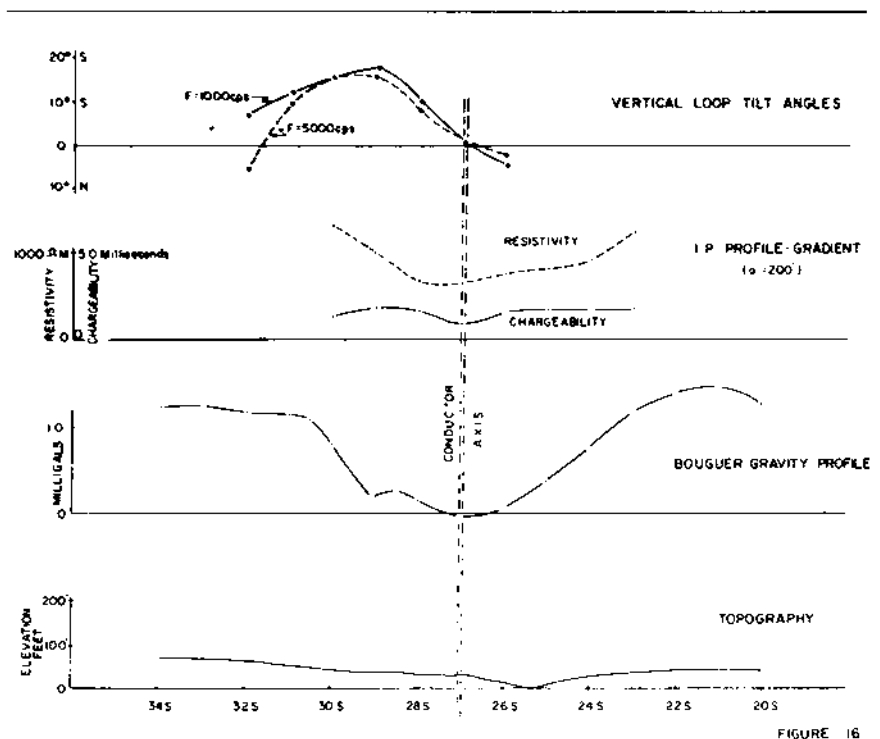

FIGURE 16

Geophysical Recognition of Overburden Trough, Northwest Quebec, Canada.

electromagnetic survey which was later proven, by drilling, to be due to overburden conduction in a bedrock trough. The I.P. response is in the low-normal range. The gravity profile, also shown, corroborates the presence of the bedrock depression.

Attempts have been made by a number of workers to employ the I.P. method in the field of groundwater exploration (e.g. Vacquier, 1957, Bodmer, 1968) but with no consistent success as yet. There are variations of chargeability from one type of non-consolidated sediment to another, but these fall, in general, within a relatively small range compared to the usual sulphide responses.

More investigation remains to be done in this area before a definitive conclusion can be reached. It is clear that more accurate measurements will have to be made in groundwater I.P. than in base metal I.P. investigations.

The I.P. method has a number of recognized limitations, some of a fundamental nature and others of a temporary nature reflecting the current state of the art. On a unit coverage basis the method is relatively expensive to apply, costing between \$200 and \$500 per line mile surveyed, in most instances. This cost has, however, been progressively reduced by advances in instrumentation resulting in decreased weight, increased

sensitivity and rejection of earth noise effects. Some degree of improvement is yet to be expected in this area.

The same geometric limitations apply as with the resistivity method employing the comparable array. As a rule, a body of up to 10 per cent disseminated metallic conductors cannot be detected at a distance from its nearest point much exceeding its mean diameter. This detectability may be somewhat improved by the use of secondary criteria, but such improvement is likely to be only marginal.

Since Overvoltage is essentially a surface phenomenon the I.P. response from a given volume percentage of metallic conductors generally increases as the individual particle size is decreased. From the usual simple I.P. measurements, therefore, one cannot reliably predict the percentage by volume of such conductors in a deposit as there may be a variation of particle size throughout the deposit.

Still less can one differentiate between metallic conductors (e.g. chalcopyrite, galena, pentlandite) of economic interest and those of non-economic interest (e.g. pyrite, pyrrhotite and graphite). In addition we cannot even reliably differentiate between metallic sources of I.P. responses. The latter may include certain types of clay and, in consoli-

dated rocks, such platy alteration minerals as serpentine, talc and sericite.

Empirically it has been found that, on the average, 1% by volume of metallic sulphides will increase the chargeability by about 2 - 3 times, depending on the host rock type.

Figure 17 shows a section across each of two anomalous I.P. areas in the Pine Point area, Northwest Territories, Canada. Section A is a discovery traverse across an ore body containing one half million tons of 11.4 per cent combined Pb and Zn and coming within 40 ft. of the ground surface. Section B is a traverse across what proved, by drilling, to be a karst sink hole, filled in with a variety of unconsolidated material including boulders and clay.

Based upon the chargeability amplitudes and the relative resistivity depressions the second case would appear to be far more promising than the first. In such cases the gravimeter has sometime proven to be of value in resolving the two types of occurrence but there is the very real possibility of the coincidence of a sink hole and a lead-zinc deposit, which would give rise to an uncertain resulting gravity response.

Any normal transient (time-domain) polarization decay and equivalently any curve of variation of apparent resistivity with frequency may be simulated by means of a mixture of metallic conductors of a suitable particle size distribution.

It is, however, possible in an area of common geology, that the various possible sources of I.P. responses may have significantly different characteristic curves in each of these two domains. A more thorough analysis of these curves at significant points is, therefore, of value.

Modern receivers in both domains (Figures 5 and 7) have the ability to give curve form information as well as a single quantity related to an I.P. amplitude.

Komarov (1967) documents such an example over a copper nickel deposit in the U.S.S.R. where, effectively the sulphide responses have a longer time constant than the normal non-metallic polarization.

An important source influencing I.P. measurements is the electromagnetic response of the earth. For a given electrode array the electromagnetic effect is dependent upon the frequency times the conductivity and the square of the spacing. In the frequency domain this source becomes troublesome (communication from P.G. Hallof) when:

1. The electrode spacing is 500 ft. or over and $n = 3$ or greater.
2. The highest frequency employed is 2.5 c.p.s. or greater.

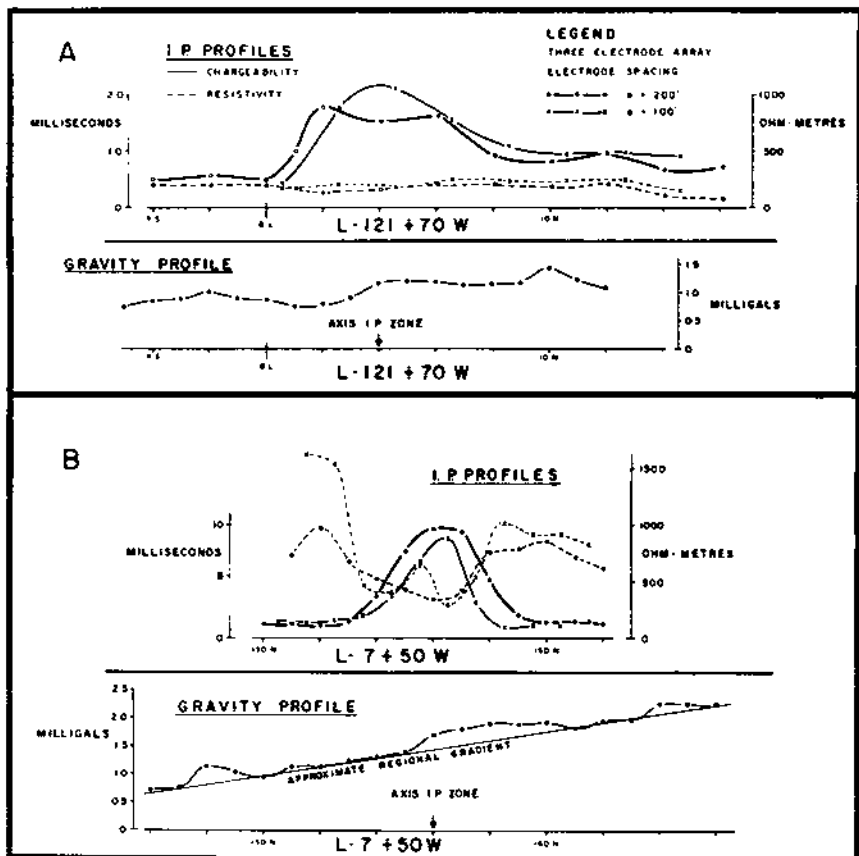

FIGURE 17

Possible Ambiguity of Induced Polarization Results, Pine Point Area, Northwest Territories, Canada.

3. The average earth resistivity is lower than about 25 ohm metres.

Electromagnetic effects are present in the time-domain measurements as well, of course, but are usually of lesser amplitude for the same array and earth conductivity, because the effective frequencies employed in the time domain are considerably lower (commonly 0.03 to 0.125 c.p.s.).

In the extreme, the electromagnetic response of a conducting earth may seriously interfere with useful I.P. measurements in either domain.

In the time domain I.P. measurements commonly only a single amplitude (at a specific time after current interruption) or an average amplitude over an interval of time after the current interruption is used to characterize the transient decay curve and act as a measure of the induced polarization characteristics of the medium in question.

It has been known since 1950 that useful secondary information is available in the shape of the transient decay curve associated with time domain induced polarization measurements. Equivalent remarks may be made in respect of frequency domain measurements where, instead of measuring the average slope of resistivity frequency over one decade of frequency, more information is obtained about the shape of this curve.

The type of information inherent in the curve shape relates primarily to two factors — (a) average metallic particle size associated with the source of an anomalous I.P. response, and (b) the presence of electromagnetic transients arising from highly conducting geologic units. For convenience we will restrict the following remarks to time domain measurements, although equivalent statements may be made in the frequency domain.

It has been established through laboratory measurements that (a) metallic conductors of large average particle size give rise to time domain decay curves of relatively long time constant, and (b) metallic conductors of small average particle size give rise to decay curves of relatively short time constant. For these reasons, if a shape factor as well as an amplitude factor of the decay curve can be established we may obtain information which is helpful in some of the following circumstances:

(1) very large or very small metallic particles — the response from these may distort the shape as well as the amplitude of the transient curve. Thus rather small amplitude anomalous metallic responses may be recognized in the presence of equal I.P. relief due only to non-metallic variations.

(2) two different types of anomalous

response materials, in the same survey area, but differing in average particle size and/or decay curve form — e.g. serpentine, graphitic particles of small average size and coarse grained metallic sulphides.

One additional and rather common circumstance is the presence of (ionically) highly conductive overburden or consolidated rock units (e.g. saline overburden or shales). These units can give rise to electromagnetic transients of sufficiently long time constant to affect the usual I.P. amplitude measurement.

The shape of the E.M. transient is, in practice, markedly different from that of the usual I.P. transient, having a much shorter time constant than the latter. In addition, the polarity of the E.M. transient is often reversed to that of the I.P. transient. Curve shape measurements can provide a clear indication of the presence of significant E.M. interference and even a semi-quantitative estimate of the latter, enough to allow a correction factor to be applied.

Equipment of the type illustrated in Figures 4 and 5 (e.g. Scintrex MK VII System) permit appropriate transient curve shape information to be obtained. Common to all the transmitters in this system is the ability to pass a repetitive, interrupted square wave pattern current

into the ground, as shown on Figure 4. The current-on time may be 2, 4, or 8 seconds and the current-off time may be likewise selected. Measurements of I.P. transient curve characteristics are made during the current-off time.

Figure 18 shows the quantities measured by the Newmont-type receiver. In these receivers one sets the gain of certain amplifiers common to both the primary voltage V_p and transient voltage V_t measurements so that these voltages are essentially normalized.

The usual amplitude measurement performed by these receivers consists of an integration of the area under the transient curve over a specified interval after the interruption of the primary current and is designated by the letter M — the "chargeability" namely, 0.45 seconds to 1.1 seconds.

The 0.45 second delay time allows most E.M. transients, switching transients and interline coupling effects to disappear prior to the making of the measurement. Different measuring intervals may be employed under specific conditions.

In addition to M, the Newmont-type MK VII receiver is equipped to measure a quantity "L" which is defined as the time integral of the area over the transient curve, for a specified time interval, taking as reference voltage the

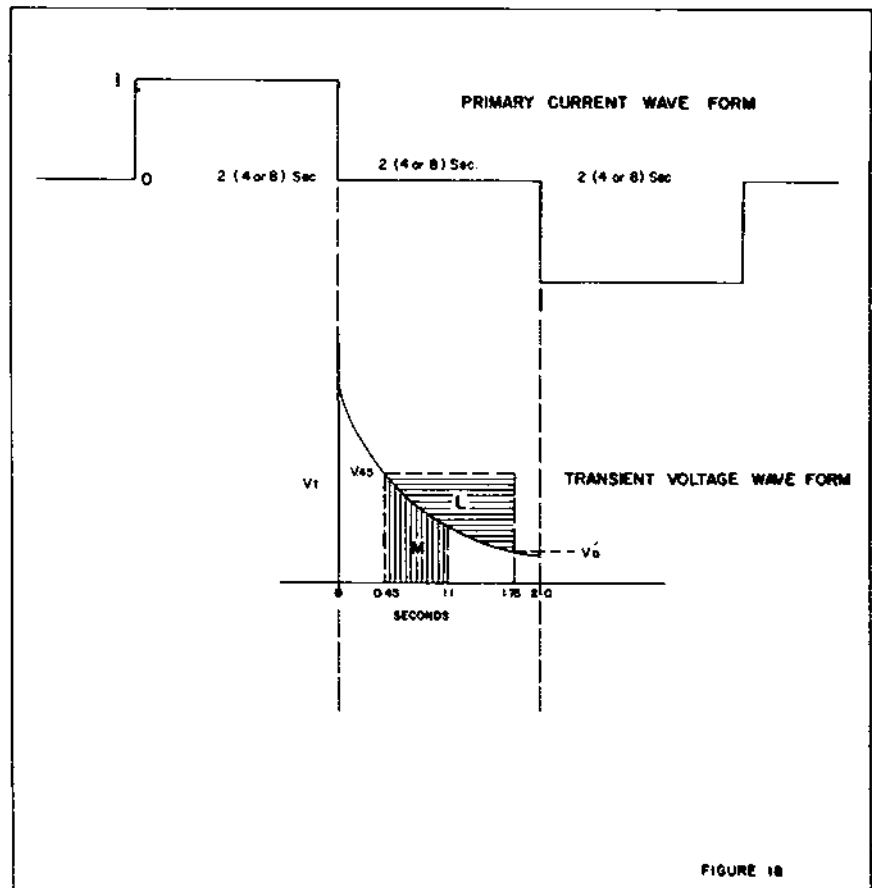

Operation of Scintrex Mk VII (Newmont-type) I.P. System.

transient voltage value at the beginning of the time interval. In practice, the interval selected is 0.45 seconds to 1.75 seconds, as shown on Figure 18, although different intervals may be employed under certain conditions.

The ratio of L/M is taken as a sensitive indication of transient curve shape. It has been well established, by many tens of thousands of I.P. measurements with these systems in many parts of the world, that the L/M measurements in non-metallic-mineralized areas, for a given current wave form, are constant within better than 20%.

Significant departures from these ratios usually imply an abnormal condition — either an anomalous metallic polarization response, electromagnetic or interline coupling.

Figure 19 shows a range of transient curves and their possible cause. For each case the "normal" transient curve is also shown. These cases illustrate the sensitivity of the L/M ratio to the transient time constant. A significant increase in L/M implies an abnormally short time constant, (Case A) reflecting either positive E.M. effects or small particle size. This should, in either case, normally be accompanied by an increase in apparent chargeability M .

A modest increase in L/M ratio, reflecting an increase in time constant (Case B) may reflect either the presence of large particle size metallic conductors, in which event an increase in M may or may not be appreciably reduced.

Cases C and D show the effect of reversed polarity E.M. transients of increasing amplitude. In Case C there is a short term V_t reversal and, although M is only slightly reduced, L/M is considerably reduced. In Case D, which is considerably more extreme, V_t is still rising at 0.45 seconds, so that L and thus L/M are, in fact, negative. M is considerably reduced from its normal value in this case, but a warning to this effect is clearly indicated by the L measurement.

A quantitative estimate of the E.M. transient response and, therefore, correction for it, may be obtained by one of a number of means. One may, for example, vary the current-on time, e.g. from 2 seconds to 8 seconds. The E.M. transient, being of relatively short time constant, will not change. The I.P. response will change by an amount which is fairly predictable, assuming a normal decay form. We thus obtain two equations in two unknowns from which the true I.P. response may be derived.

Curve shape measurements may be made in other ways as well, for example, by actually recording the complete transient decay curve. Whereas theoretically useful, such

measurements have proven unwieldy from a weight and time standpoint. To obtain clean decay curves requires a high signal/noise ratio and thus high powers.

In the frequency domain the equivalent curve form information would be obtained through the use of three or more properly selected operating frequencies.

There is a continuing rivalry between protagonists of time-domain and frequency domain measurements. All that is clear is that neither method is superior in all respects to the other. The same phenomenon is being measured in different ways often with different arrays and the results are presented different formats (pseudo-sections in the frequency domain versus profiles in or contour plans in the time domain).

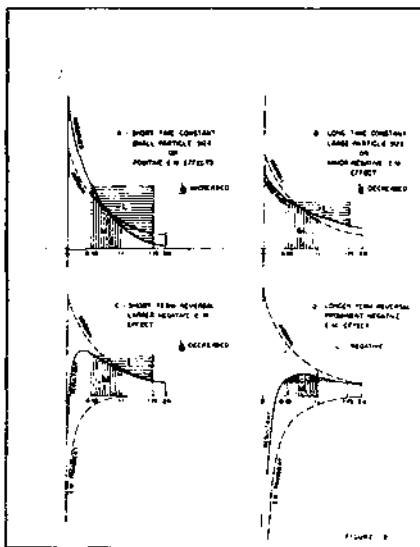

Significance of Curve Shape (L/M) Information.

The "Metal Factor", which is a mixture of physical properties, is commonly presented with frequency domain measurements only. These differences are largely superficial and are based on separate historical developments and subjective preferences.

There is a direct mathematical transformation between I.P. measurements in the two domains. Theoretically, at least, the same information can be obtained in either domain. Practically, however, there are certain differences.

The time domain measurements are absolute, i.e. are measured in the absence of the steady state voltage and are disturbed only by earth noises as a background. The amplitude of these measurements is usually less than 1% of the steady state voltage, but even so they can usually be made to an accuracy of better than 10 per cent even in unmineralized rocks.

The limit of useful sensitivity is related only to the regional uniformity of the background I.P. response. In the frequency domain the I.P. response is measured as a difference in transfer impedances. This difference can be measured with an accuracy of only 0.3% with extremely stable equipment. Since the non-metallic background P.F.E. over the interval of 0.1 to 2.5 c.p.s. is usually less than 1%, the probable error of these measurements may be 30% or more.

For this reason it is seen that it is feasible to obtain greater sensitivity of measurement in the time domain. This increased sensitivity is of value in areas of low "geologic" and electrical noise. By "geologic noise" is meant the range of variation of I.P. parameters within the normal rock types of the area. The application of I.P. to groundwater prospecting may have to develop through the time domain avenue because of the sensitivity requirements.

The frequency domain equipment requires somewhat less primary power than the time domain equipment because the former measurements in an A.C. one with the ability to use tuned filters and amplifiers as well as devices as phase-lock detectors. This advantage is not so marked as it once was, as current time-domain equipment, with its self adjusting earth voltage balance and ability to sum any desired number of integrations, provides a high degree of noise rejection.

Under truly random noise conditions the summation of n integrations provides the usual $1/\sqrt{n}$ reduction in statistical noise and is a powerful non-subjective means of noise suppression. The suppression of A.C. power line noise is much better with the time domain (integrating type) measurements than with frequency domain measurements.

Reference has already been made above to the relative effects of the electromagnetic response of the earth in both methods. Similar remarks apply to capacitive and inductive coupling effects between current and potential cables, although such effects can be largely avoided in any event by careful positioning of the cables, except possibly in drill hole surveying. So far, only in the time domain may useful drill hole measurements be made with both current and potential electrodes lying side by side in a small diameter bore hole.

An individual geologist or geophysicist may have had his first acquaintance with or instruction in the I.P. method using either the time domain or frequency domain. He becomes familiar with the arrays used and with the method of presentation of data employed. Thereafter, he tends to

resist switching to the other domain in the belief that not only will he have to deal with different geophysical equipment and electrode arrays but also with different quantities, presented in quite a different fashion. This is erroneous.

So far as arrays are concerned the time domain uses them all – dipole-dipole, pole-dipole (three electrode) Wenner and gradient (Schlumberger). The frequency domain commonly uses only the first two and is restricted from using the latter two because of interline coupling effects.

Of the quantities measured in both domains the resistivity is, of course, the same, making due allowance for units. The time domain "Chargeability" is, normally very nearly proportional to the "Percent Frequency Effect" or "P.F.E.". The so-called "Metal Factor" is the ratio of P.F.E./Resistivity, and would, therefore, be equivalent to the ratio of Chargeability/Resistivity.

The time domain data presentation

is commonly in the form of profiles and contour plans.

The frequency domain presentation is commonly in the form of "pseudo-sections" showing the different spacing results displaced progressively downwards with increased electrode spacing. Either type of data may be presented in either form of course, to suit the tastes and experience of the individual geologist or geophysicist.

The Gradient array is very useful in obtaining bedrock penetration where the bedrock is highly resistive compared to the overlying overburden. In such cases using the pole-dipole or dipole-dipole array very little current actually penetrates the bedrock and the I.P. characteristics observed are those of the overburden only. As was mentioned above, only time domain measurements may be carried out using this array.

There is a special practical advantage to the time domain measurements in areas where it is very difficult to make good ground contact. In such areas the

problem of keeping the primary current, rigidly constant, necessary for the frequency domain measurements, becomes severe.

In the time domain, if the primary current varies by as much as 10% during the measurement the absolute error in the chargeability may only be about 5%, which is not significant. This problem is often encountered in very arid areas, e.g. parts of Peru, Chile and other desert regions.

Despite these slight effective differences both methods of I.P. exploration have amply demonstrated their value through important mineral discoveries in many parts of the world. The role of I.P. in mineral exploration is well acknowledged and rapidly expanding.

The writer wishes to thank the various sources of case histories and illustrations cited in the text and in particular, Dr. Keeva Vozoff and Dr. Philip Hallof for valuable contributions.

Bibliography

- Bleil, D. F. (1953)
"Induced Polarization, A Method of Geophysical Prospecting" – *Geophysics*, Vol. 18, pp. 636-661.
- Bodmer, R., Ward, S. H. and Morrison, H. F. (1968)
"On Induced Electrical Polarization and Groundwater", *Geophysics*, Vol. 33, pp. 805-821.
- Dakhnov, B. N. (1941)
"Electrical Well Logging, Interpretation of Electric Logs", Moscow, Chapter IV.
- Dieter, K., Paterson, N. R. and Grant, F. S. (1969)
"I.P. and Resistivity Type Curves for Three Dimensional Bodies". *Geophysics*, Vol. 34, pp. 615-632.
- Hallof, P. G. (1957)
"On the Interpretation of Resistivity and Induced Polarization Results" Doctoral Thesis, M.I.T. Department of Geology and Geophysics.
- Komarov, B. A. (1967)
"Induced Polarization Method". Lecture read at Interregional Seminar of UNO on New Methods for Mineral Exploration with Emphasis on Geophysical Techniques. Moscow, U.S.S.R. July 1967.
- Madden, T. R. et al (1957)
"Background Effects in the Induced Polarization Method of Geophysical Exploration", A.E.C. Report R.M.E. 3150.
- Marshall, D. J., and Madden, T. R. (1959)
"Induced Polarization, a Study of its Causes" – *Geophysics* Vol. XXIV, pp. 790-816.
- Schlumberger, C. (1920)
"Etude sur la Prospection Electrique du Sous Sol". Gauthier-Villars et Cie. Paris (1920) Chapter 8, (Revised 1930).
- Scott, W. J. and West, G. F. (1969)
"Induced Polarization of Synthetic, High-Resistivity Rocks Containing Disseminated Sulphides" – *Geophysics*, Vol. 34, pp. 87-100.
- Seigel, H. O. (1948)
"Theoretical Treatment of Selected Topics in Electromagnetic Prospecting" – National Research Council of Canada, Unpublished, pp. 34-53.
- Seigel, H. O. (1949)
"Theoretical and Experimental Investigations into the Application of the Phenomenon of Overvoltage to Geophysical Prospecting" Unpublished Doctoral Dissertation, University of Toronto.
- Seigel, H. O. (1959)
"Mathematical Formulation and Type Curves for Induced Polarization" *Geophysics* Vol. XXIV, pp. 547-563.
- Sunde, E. D. (1949)
"Earth Conduction Effects in Transmission Systems" Van Nostrand Co., N. Y. (Monograph)
- Vacquier, V. et al (1957)
"Prospecting for Ground Water by Induced Electrical Polarization" *Geophysics* Vol. 22, pp. 660-687.
- Wagg, D. M. and Seigel, H. O. (1963)
"Induced Polarization in Drill Holes" *Can. Min. Journ.*, April.
- Wait, J. R. (Editor) (1959)
"Overvoltage Research and Geophysical Applications" – Pergamon Press, London, 1959.

Additional copies of this reprint are available from:

Scintrex Limited,
(HEAD OFFICE),
222 Snidercroft Road,
Concord, Ontario, Canada.

Seigel Associates Limited,
750-890 West Pender Street,
Vancouver,
British Columbia.

Seigel Associates Limited,
222 Snidercroft Road,
Concord, Ontario, Canada.

Scintrex Airborne
Geophysics Inc.,
4425-East 31st Street,
Tulsa, Oklahoma, 74135.

Seigel Associates Limited,
115 Moorgate,
London EC2, England.

Seigel Associates
(International) Ltd.,
P.O. Box 627,
30 Duke Street,
Kingston, Jamaica.

Mineral Surveys Inc
(Western Division),
178 West 2950 South,
Salt Lake City,
Utah, 84115.

Seigel Associates
Australasia Pty. Ltd.,
11 King Street, Boulder,
West Australia, 6432.

Seigel Asociados S.A.
de C.V., Av. Hangares
de Aviacion No. 41,
Mexico 9, D.F.



SCINTREX

W 92 88 84 80 76 72 68 64 60 56 52 48 44 40 36 32 28 24 20 16 12 W

W 42 38 34 30 26 22 18 14 10 W

L-150 N

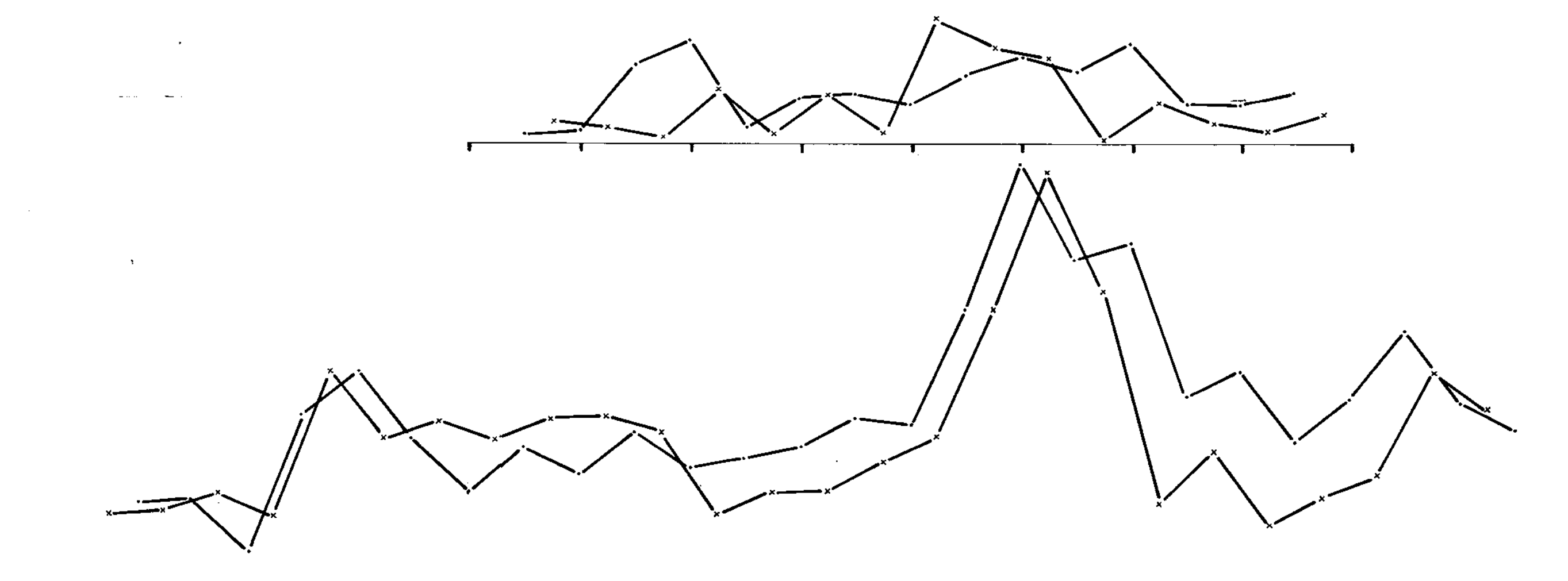

L-72 N

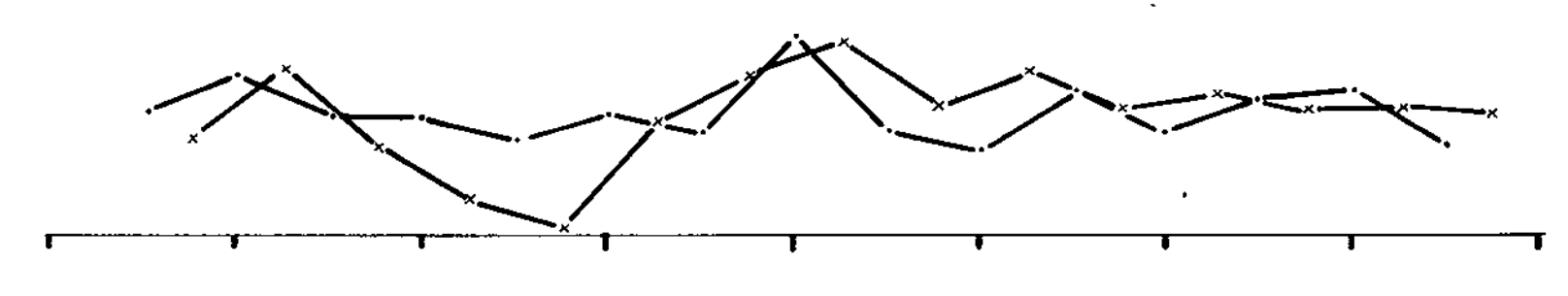

L-136 N

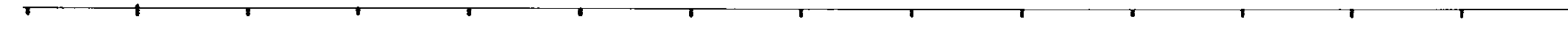

L-64 N

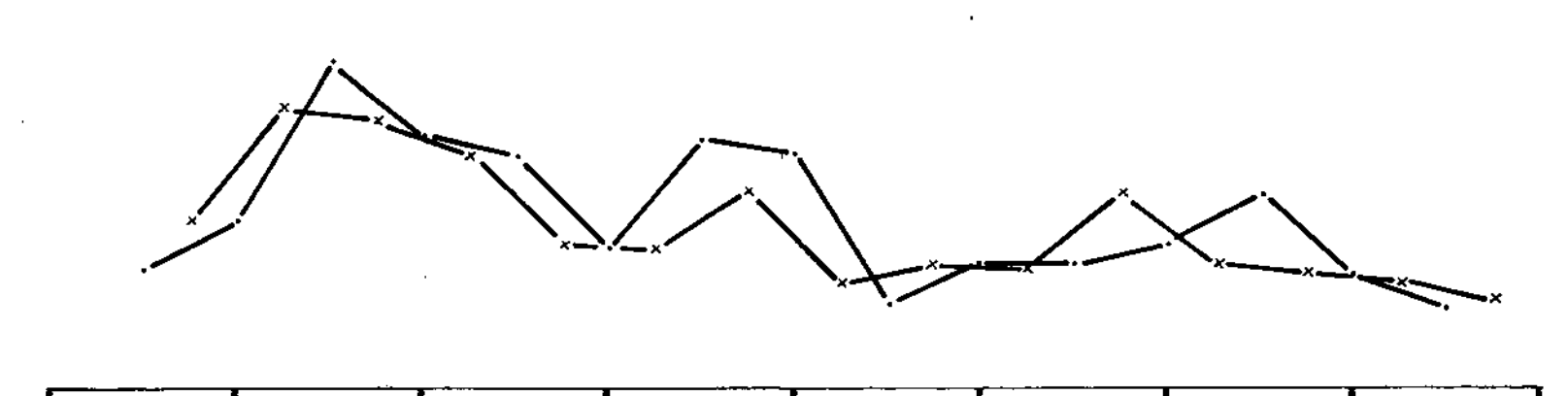

L-128 N

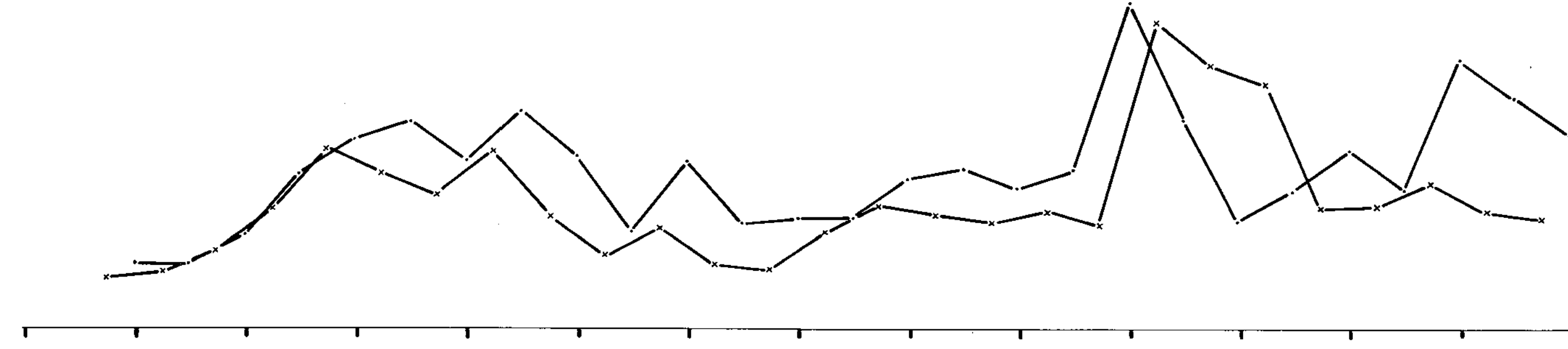

L-56 N

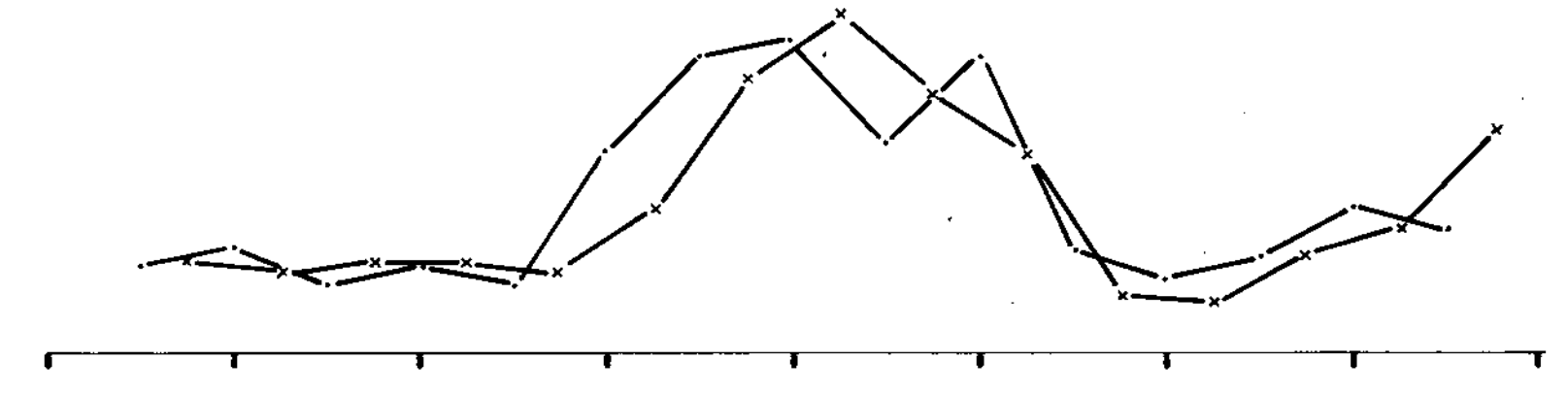

L-120 N

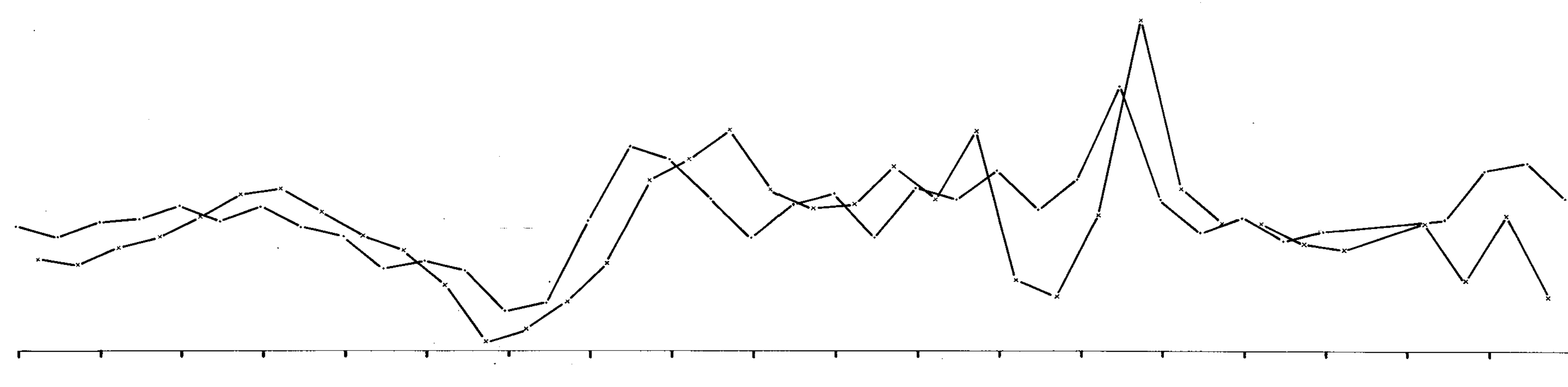

L-48 N

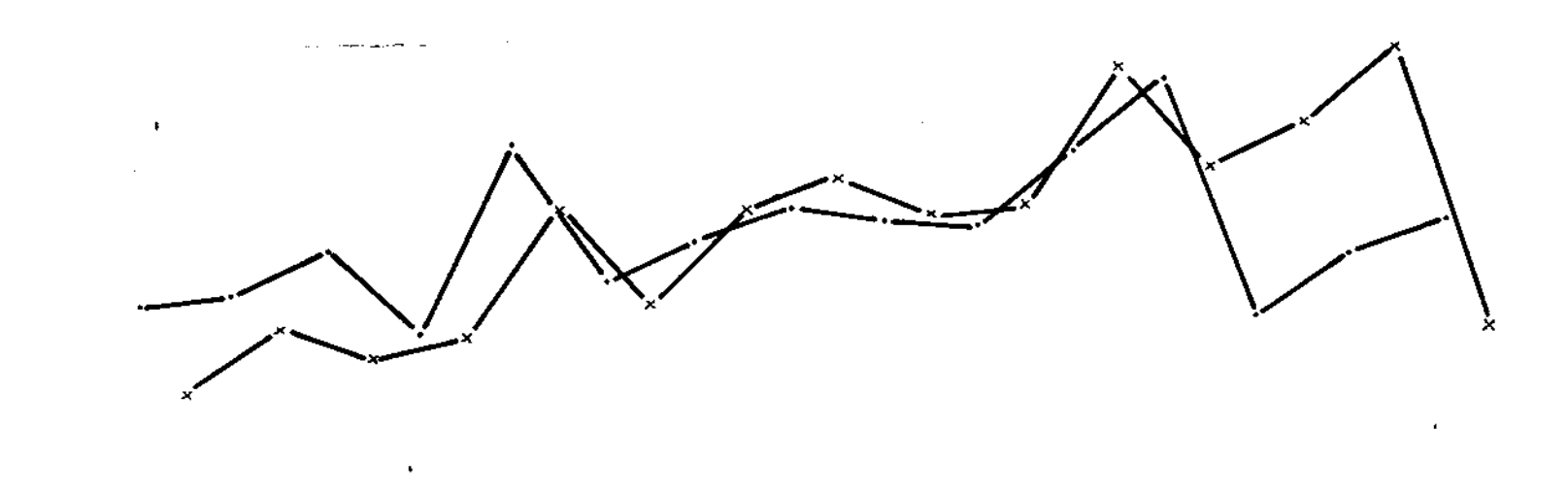

L-112 N

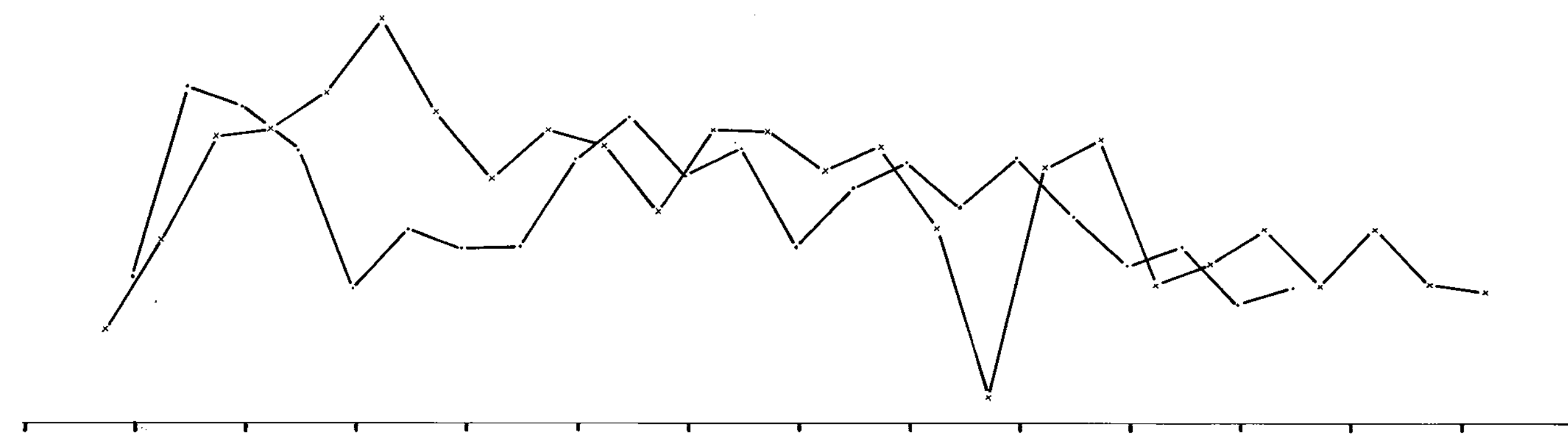

L-40 N

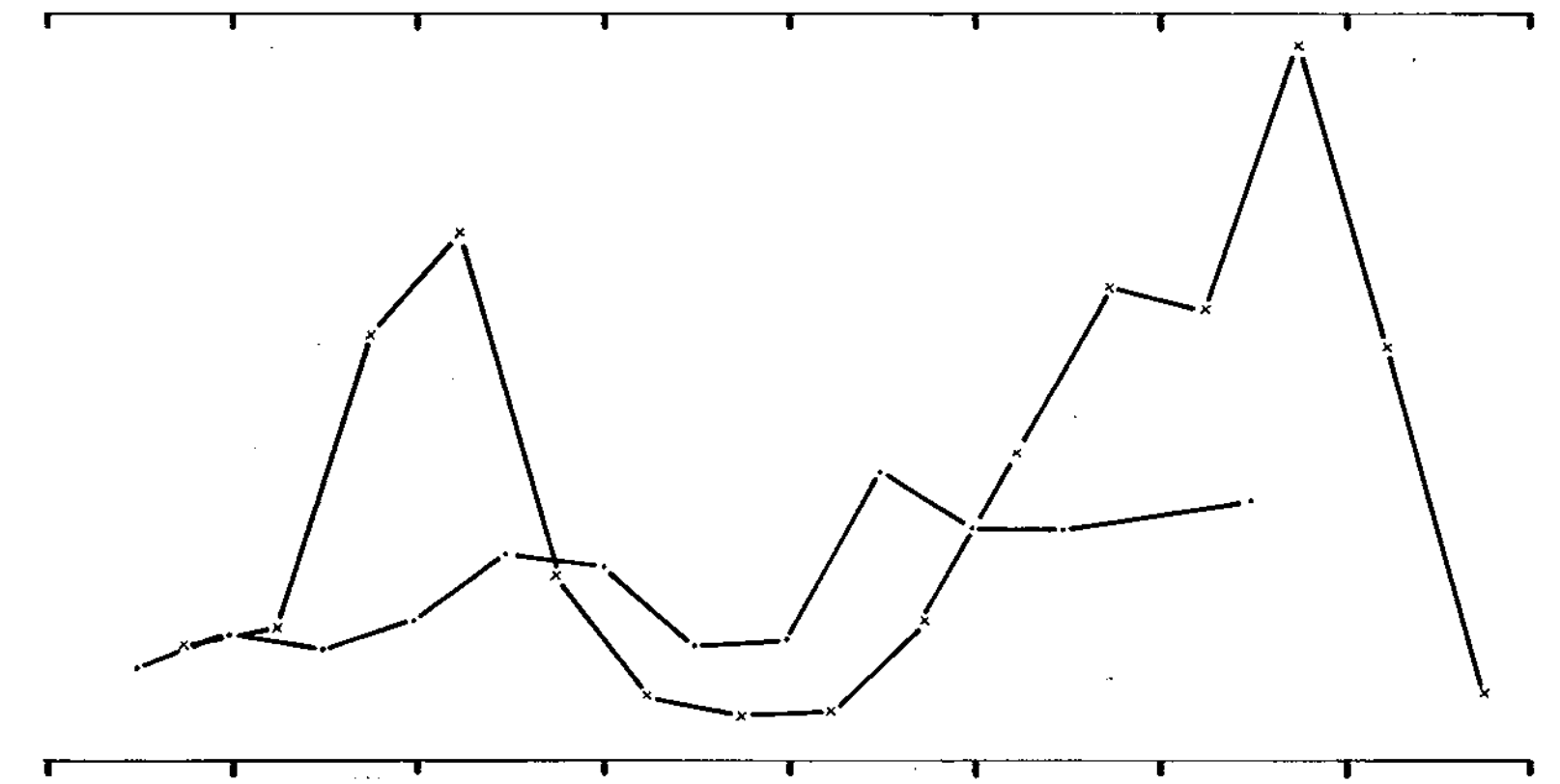

L-104 N

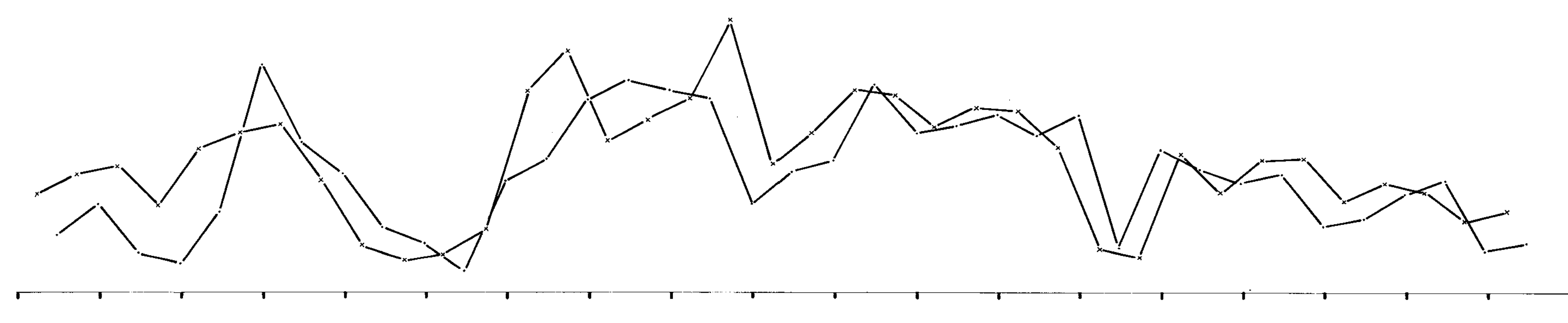

L-32 N

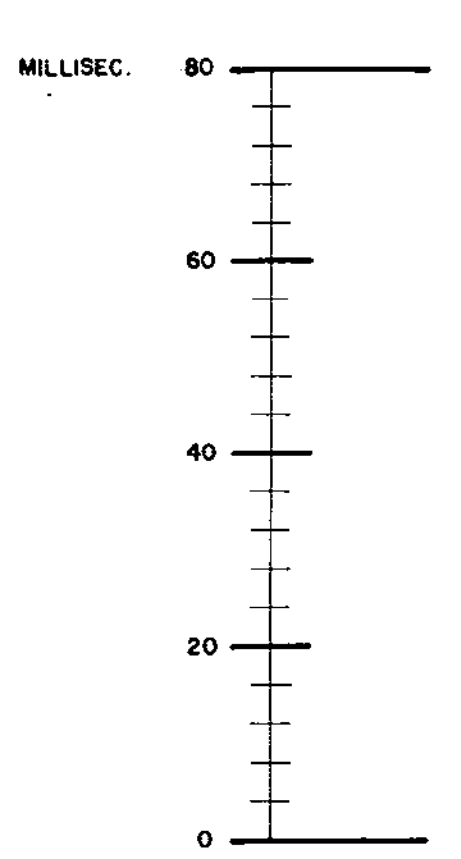
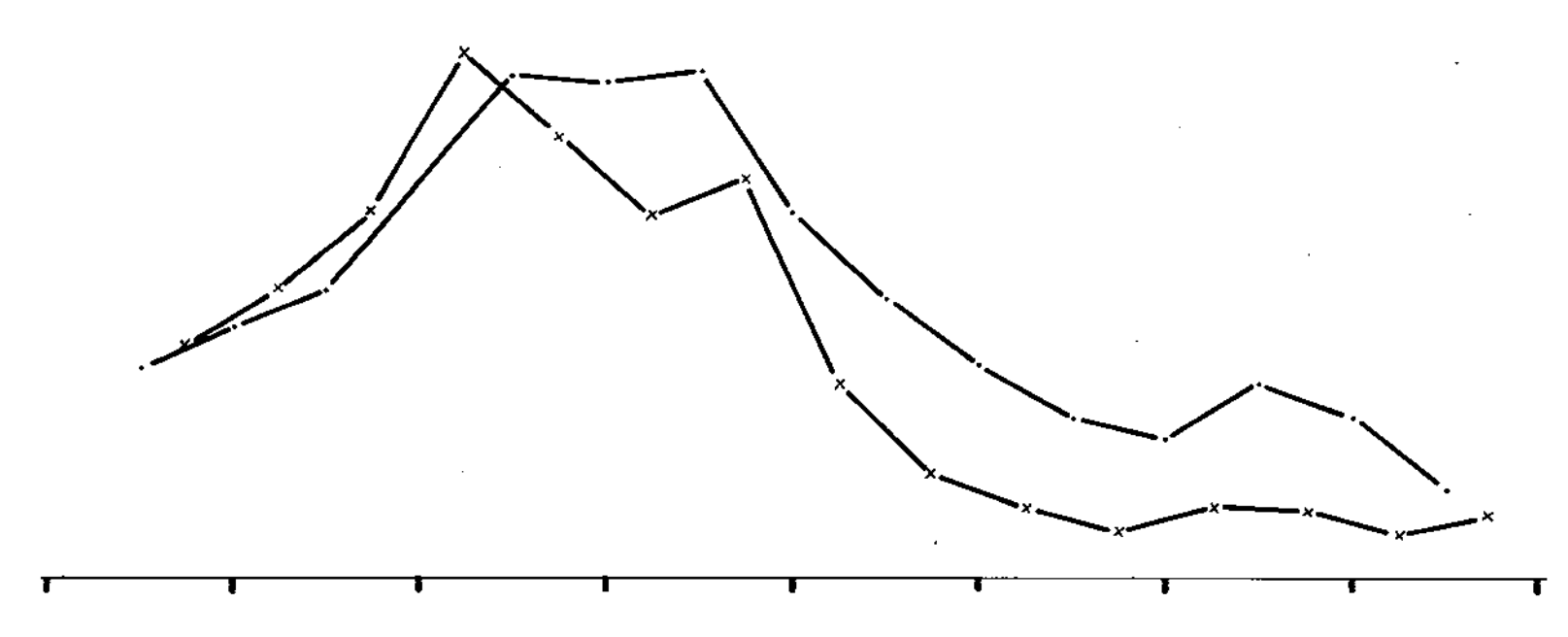

L-96 N

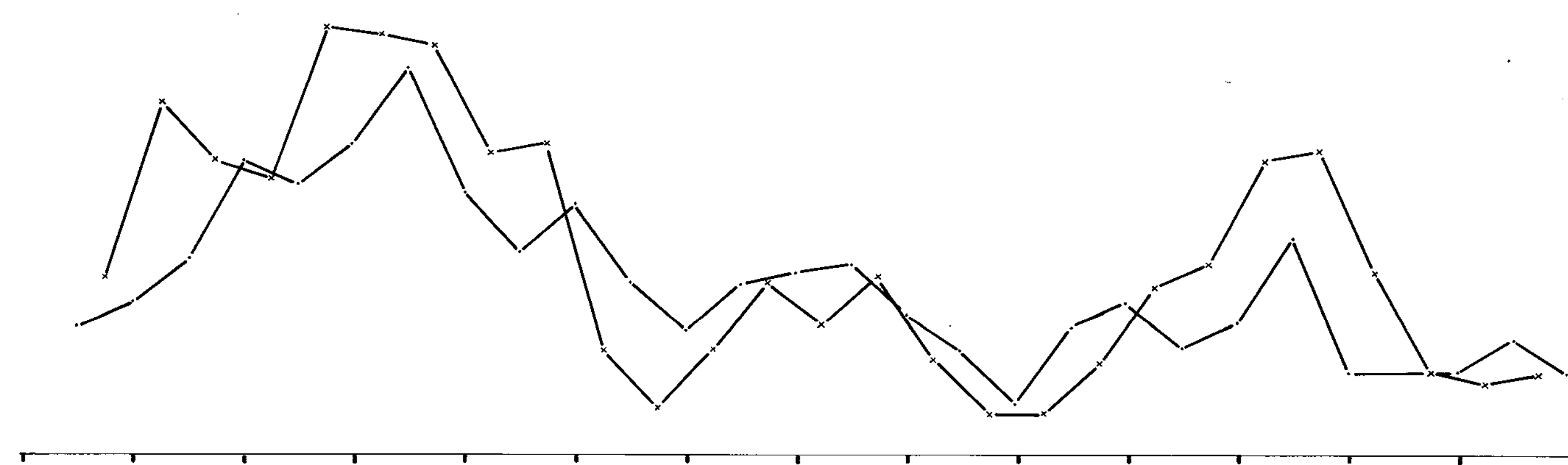

L-24 N

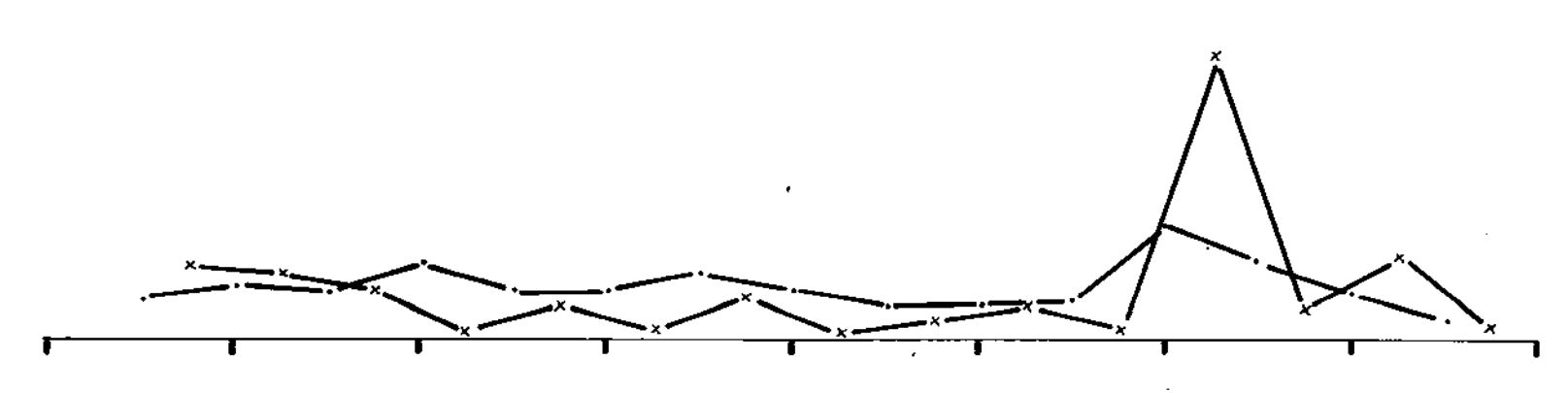

L-88 N

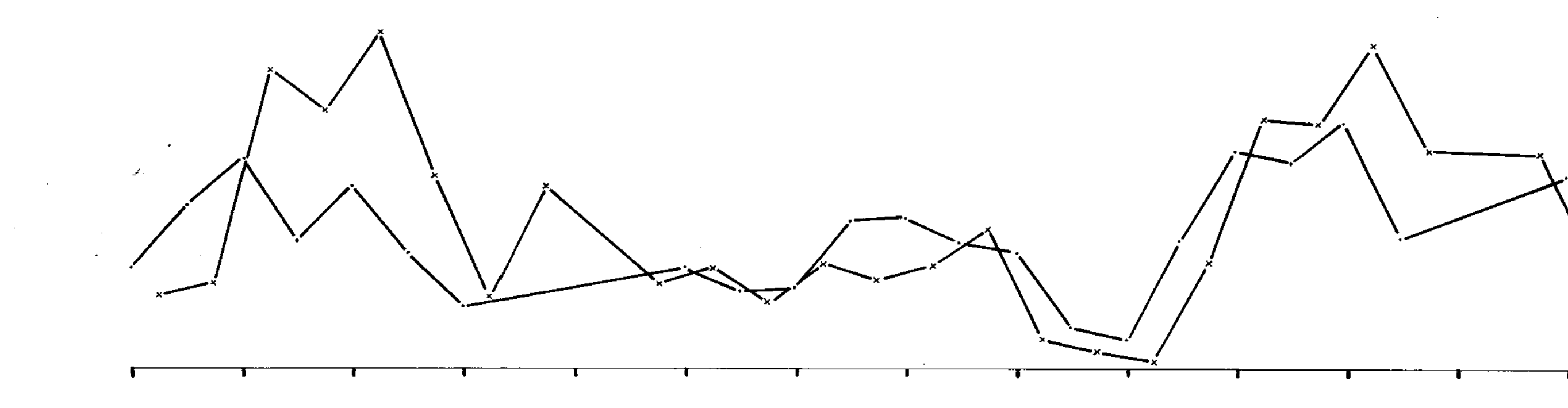

L-16 N

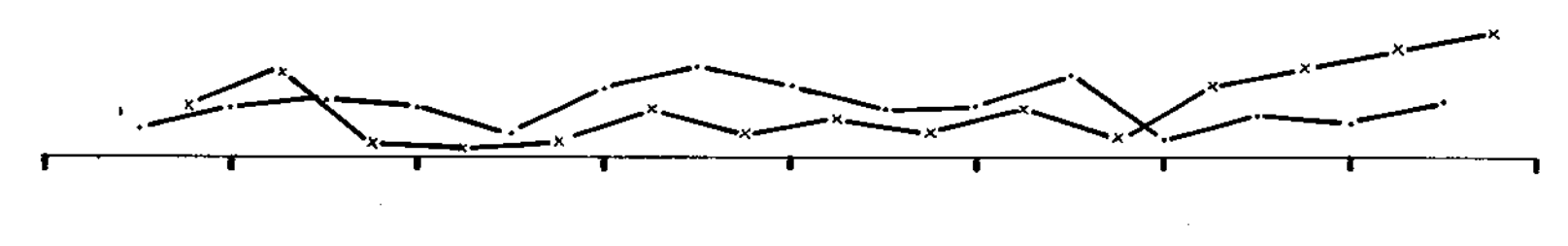

W 92 88 84 80 76 72 68 64 60 56 52 48 44 40 36 32 28 24 20 16 12 W

W 42 38 34 30 26 22 18 14 10 W

4246 M-2

LEGEND

CHARGEABILITY SCALE 1 inch = 20 MILLISECONDS
ELECTRODE SPACING 1: 400 2: 800

NOTES

SCHREX MK VII INDUCED POLARIZATION INSTRUMENTATION.
THREE ELECTRODE ARRAY
infinite current electrode C₂ moving current electrode C₁ potential electrodes P₁ P₂
INTERLINE SPACING NOT TO SCALE.

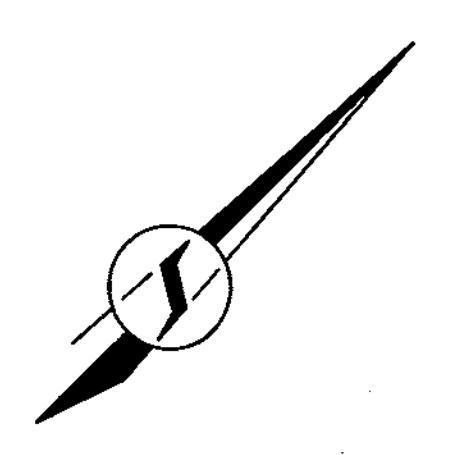

PLATE I
SULLIVAN AND RODGERS
 MANSON CREEK AREA, B.C.

Department of
 Mines and Petroleum Resources
 ASSESSMENT REPORT
 NO. 4246 M-2

CHARGEABILITY PROFILES
 OF
INDUCED POLARIZATION SURVEY
 SCALE 1" = 400'
 BY
 SCHREX SURVEYS LIMITED

TO ACCOMPANY A GEOPHYSICAL REPORT BY
 MICHAEL S. LEWIS AND P. J. FOMOFF
 DATED: 27 OCTOBER 1972

WORK COMPLETED: 28.9.1972
 DRAFTED: 24.10.1972
 REV: 1

JOB NUMBER
 889

SHEET NUMBER
 1 OF 1

W 92 88 84 80 76 72 68 64 60 56 52 48 44 40 36 32 28 24 20 16 12 8 4 W

L-136 N
L-128 N
L-120 N
L-112 N
L-104 N
L-96 N
L-88 N

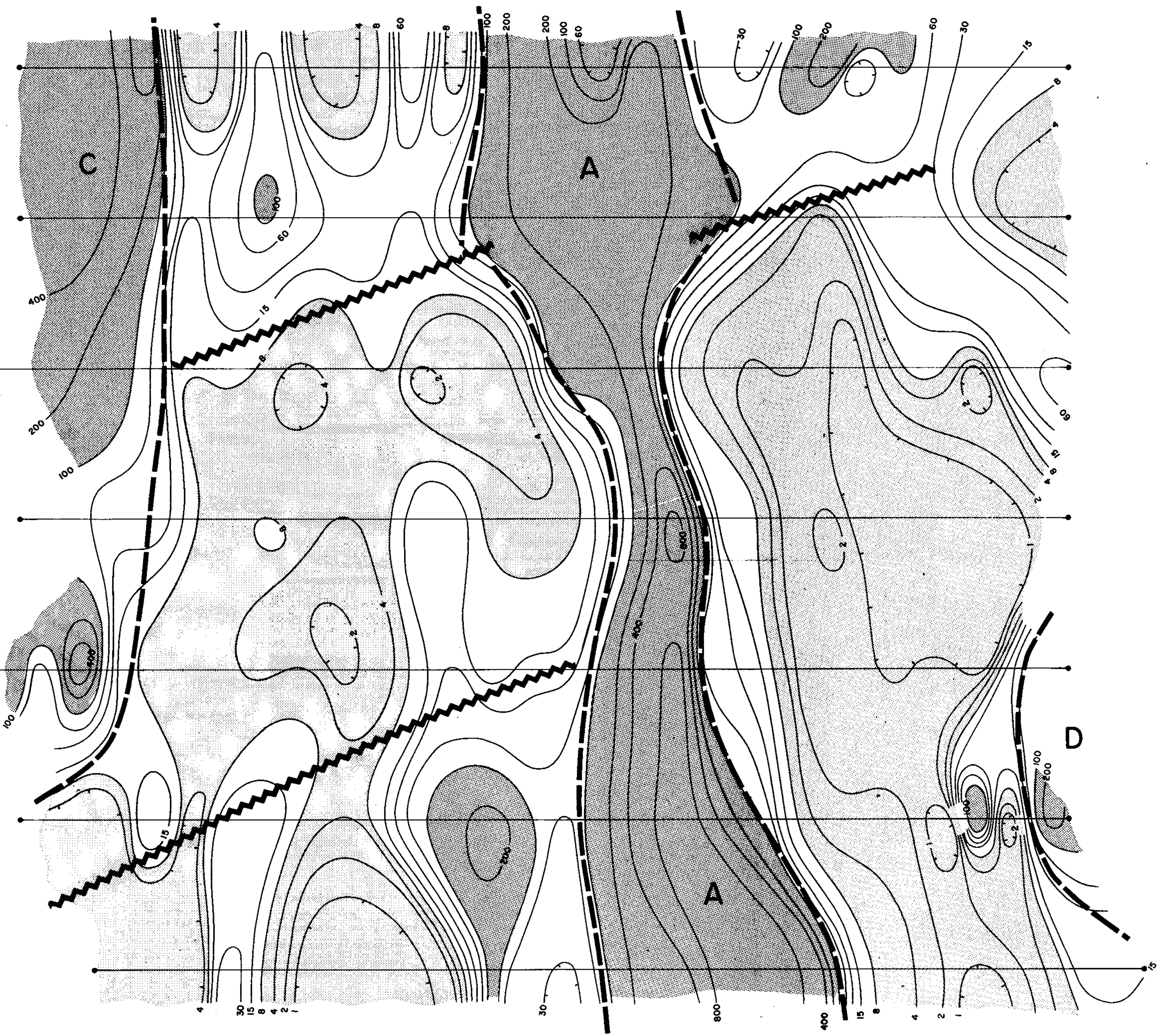

L-72 N
L-64 N
L-56 N
L-48 N
L-40 N
L-32 N
L-24 N
L-16 N

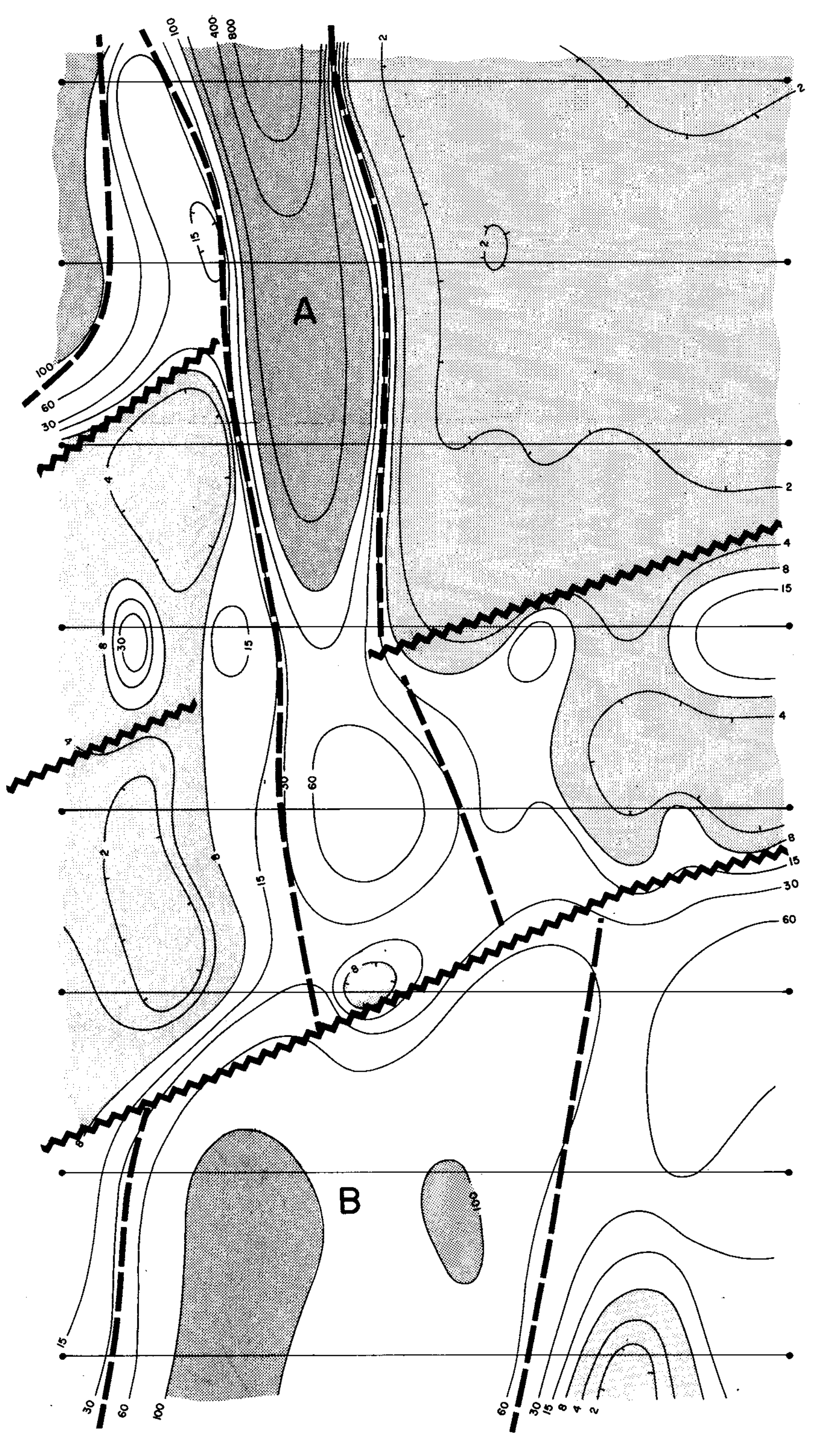

W 92 88 84 80 76 72 68 64 60 56 52 48 44 40 36 32 28 24 20 16 12 8 4 W

LEGEND

- MODIFIED LOGARITHMIC CONTOUR INTERVAL AS INDICATED.
- AREAS EXHIBITING MORE THAN 100 OHM-METERS RESISTIVITY
- AREAS EXHIBITING LESS THAN 8 OHM-METERS RESISTIVITY
- FORMATION BOUNDARY
- FAULT ?

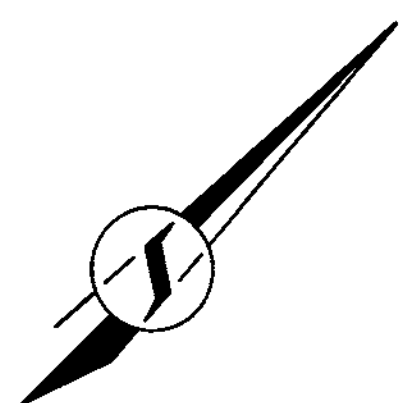
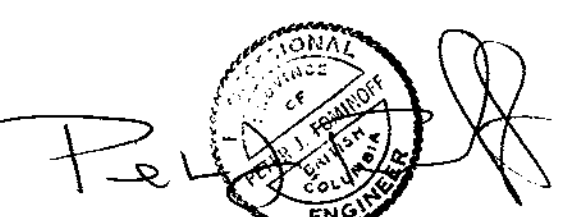

PLATE 4
SULLIVAN AND RODGERS
MANSON CREEK AREA, B.C.

Department of
Mines and Petroleum Resources
ASSESSMENT REPORT
NO. 4246 MAP #5

RESISTIVITY CONTOUR PLAN
OF
INDUCED POLARIZATION SURVEY

200' ELECTRODE SPACING
SCALE 1" = 400'
BY
SCINTREX SURVEYS LIMITED
VANCOUVER B.C.



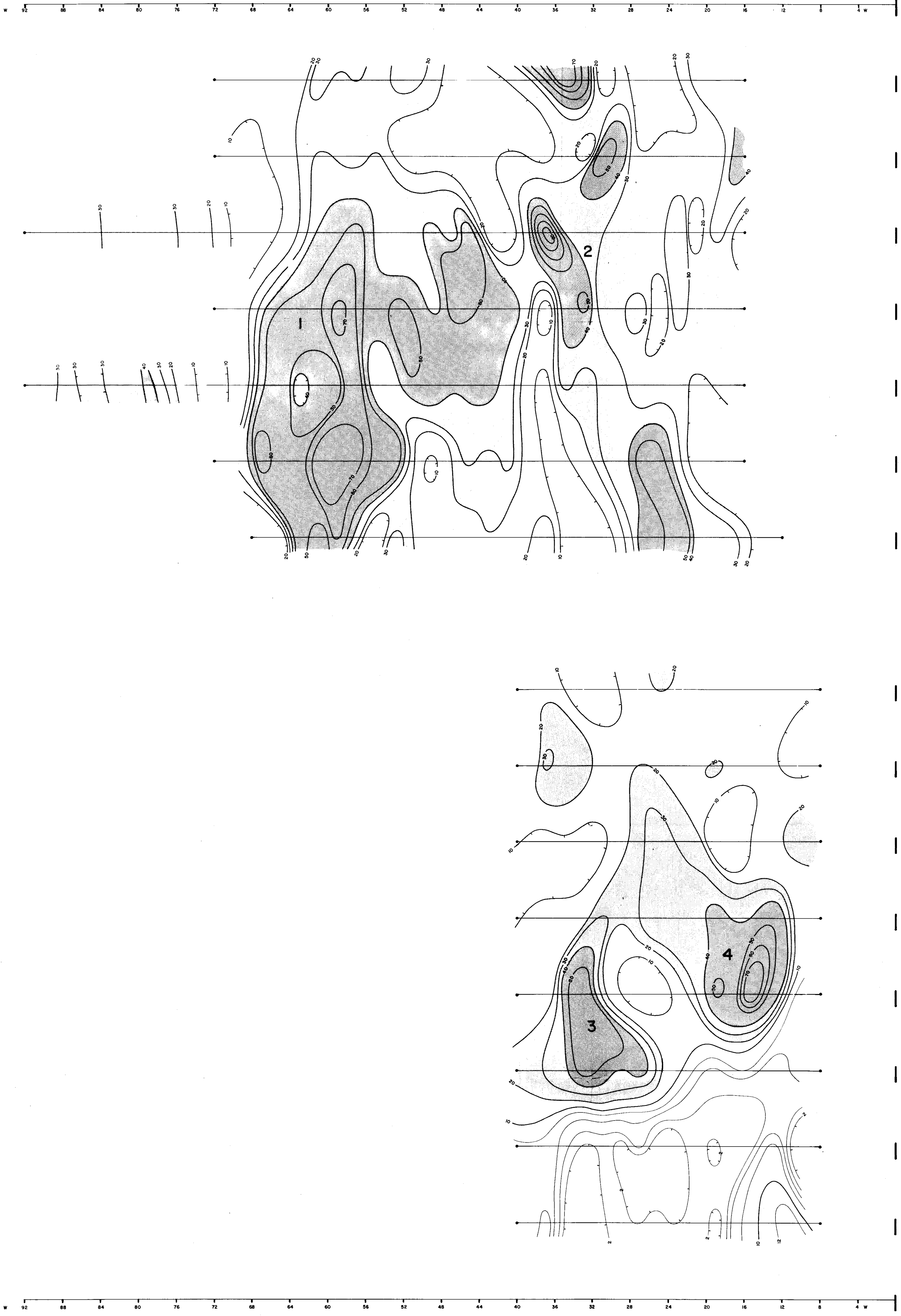

LEGEND

CONTOUR INTERVAL AS INDICATED
 AREAS OF MORE THAN 40.0 MILLISECONDS
 AREAS OF MORE THAN 20.0 MILLISECONDS

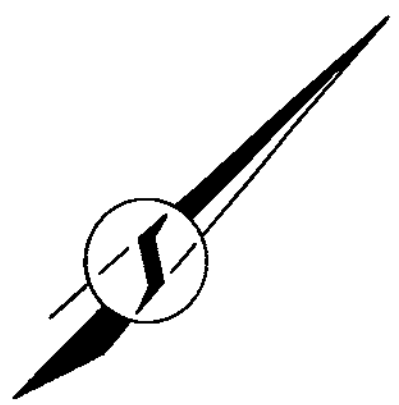

PLATE 3
SULLIVAN AND RODGERS
 MANSON CREEK AREA, B.C.

Department of
 Mines and Petroleum Resources
 ASSESSMENT REPORT
 NO. 4246 MAP #4

CHARGEABILITY CONTOUR PLAN
 OF
INDUCED POLARIZATION SURVEY

200' ELECTRODE SPACING
 SCALE 1" = 400'
 BY
 SCINTREX SURVEYS LIMITED

Michael J. Lewis

TO ACCOMPANY A GEOPHYSICAL REPORT BY MICHAEL J. LEWIS AND P. J. FOMOFF DATED 27. OCTOBER 1972	WORK COMPLETED: 28.9.1972 DRAFTED: 24.10.1972 REV.	JOB NUMBER 889	SHEET NUMBER 1 OF 1
---	--	-------------------	------------------------

W 92 88 84 80 76 72 68 64 60 56 52 48 44 40 36 32 28 24 20 16 12 W

W 42 38 34 30 26 22 18 14 10 W

L-150 N

L-72 N

L-136 N

L-64 N

L-128 N

L-56 N

L-120 N

L-48 N

L-112 N

L-40 N

L-104 N

L-32 N

L-96 N

L-24 N

L-88 N

L-16 N

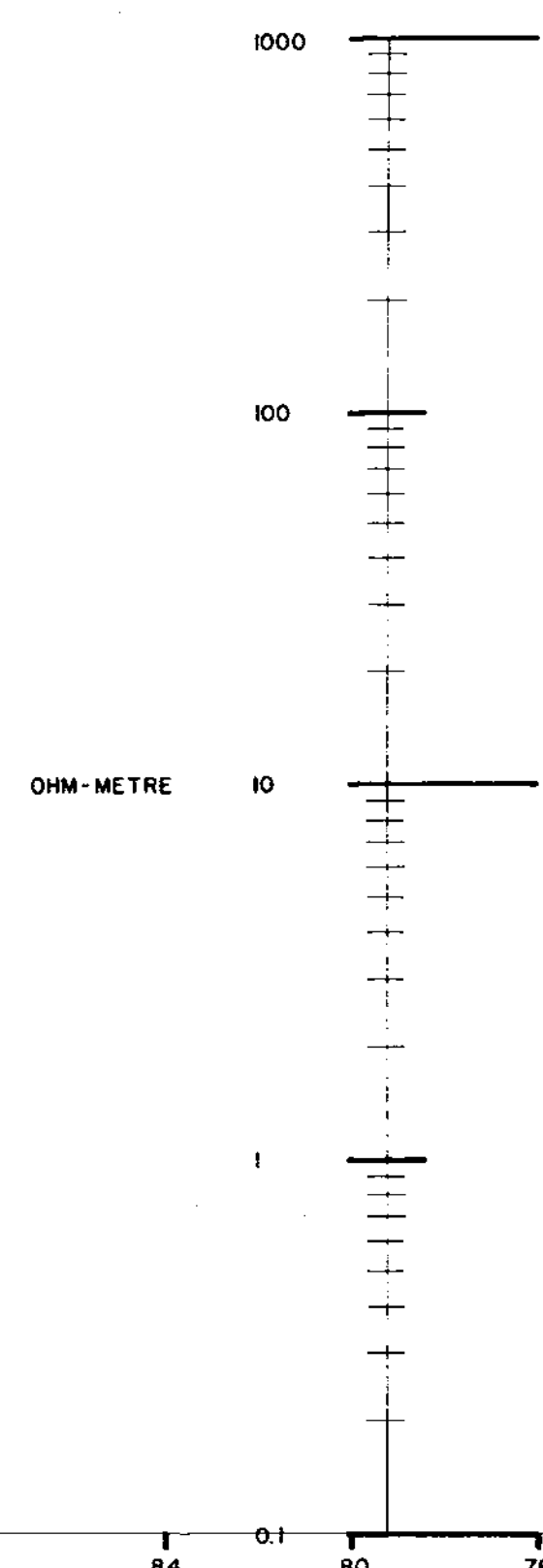

W 92 88 84 80 76 72 68 64 60 56 52 48 44 40 36 32 28 24 20 16 12 W

W 42 38 34 30 26 22 18 14 10 W

LEGEND

RESISTIVITY SCALE: 2 inches = 1 LOGARITHMIC CYCLE WITH BASELEVEL TAKEN AS 10 OHM-METRES

ELECTRODE SPACING: 400' --- 200' - - - - -

NOTES

SCINTREX M6 VII INDUCED POLARIZATION INSTRUMENTATION.

THREE ELECTRODE ARRAY

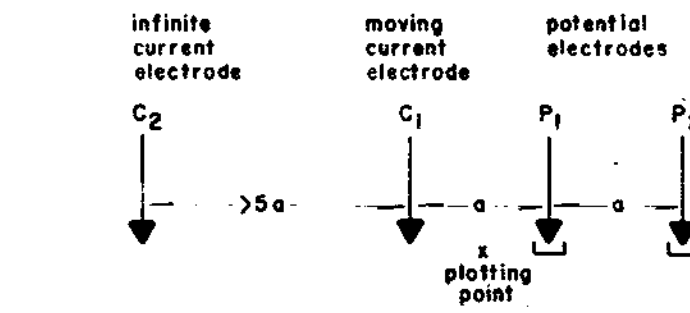

INTERLINE SPACING NOT TO SCALE.

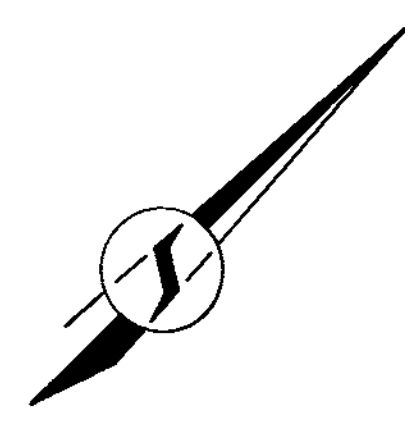

PLATE 2
SULLIVAN AND RODGERS
 MANSON CREEK AREA, B.C.

Department of
 Mines and Petroleum Resources
 ASSESSMENT REPORT
 NO. 4246 M.P. #3

RESISTIVITY PROFILES
 OF
INDUCED POLARIZATION SURVEY
 SCALE 1" = 400'
 BY
 SCINTREX SURVEYS LIMITED

TO ACCOMPANY A GEOLOGICAL REPORT BY MICHAEL A. LEWIS AND P. J. FOSNOFF
 WORK COMPLETED: 26.9.1972
 DATED: 27. OCTOBER 1972

JOB NUMBER: 889
 SHEET NUMBER: 1 OF 1

L-120 N
CHARGEABILITY

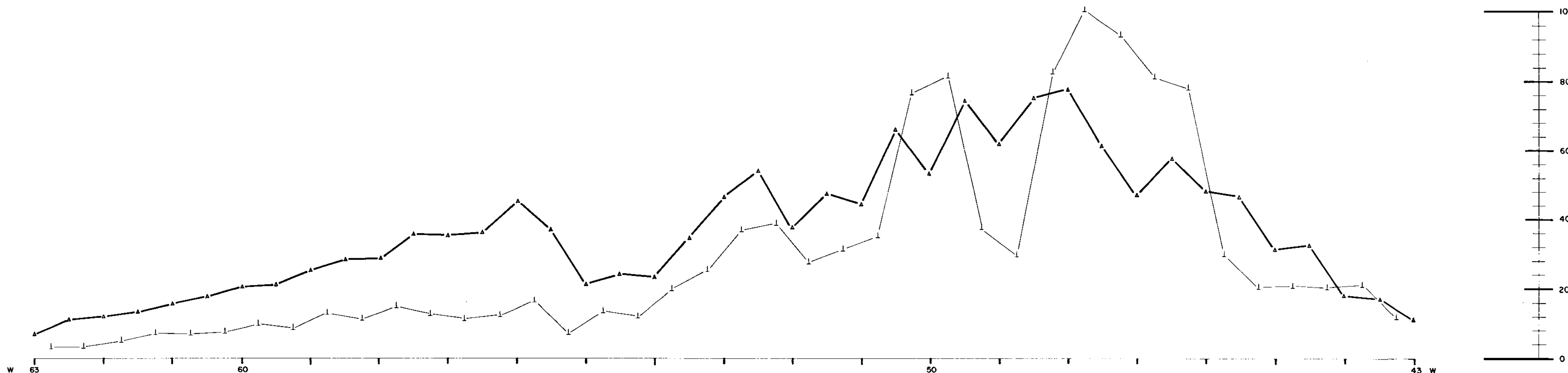

L-120 N
RESISTIVITY

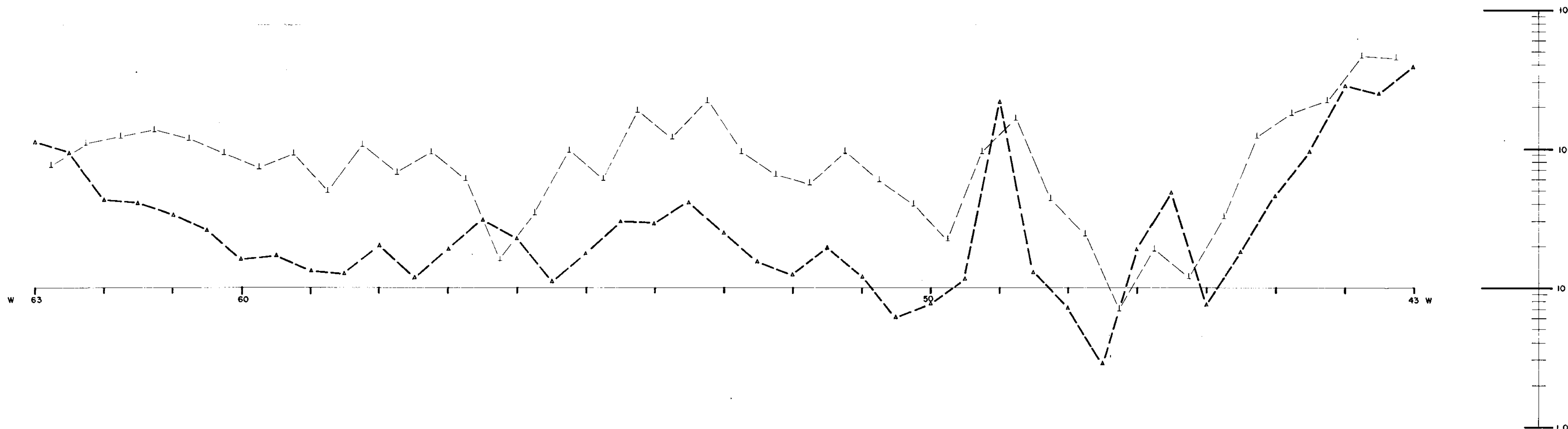

LEGEND

CHARGEABILITY SCALE 1 inch = 20 MILLISECONDS

ELECTRODE SPACING

a = 100' ———▲———▲———
a = 50' ———▲———▲———

RESISTIVITY SCALE: 2 inches = 1 LOGARITHMIC CYCLE WITH BASELEVEL TAKEN AS 10 OHM-METERS

ELECTRODE SPACING

a = 100' ———▲———▲———
a = 50' ———▲———▲———

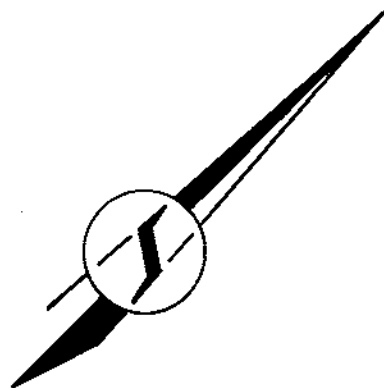

NOTES

SCINTREX MK VII INDUCED POLARIZATION INSTRUMENTATION.

THREE ELECTRODE ARRAY

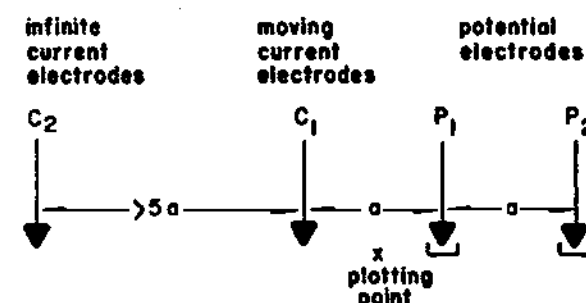

INTERLINE SPACING NOT TO SCALE.

PLATE 5
SULLIVAN AND RODGERS
MANSON CREEK AREA, B.C.

Department of
Mines and Petroleum Resources
ASSESSMENT REPORT
NO. 4246 MAP #6

CHARGEABILITY AND RESISTIVITY PROFILES
OF
INDUCED POLARIZATION SURVEY

SCALE 1" = 100'

BY

SCINTREX SURVEYS LIMITED

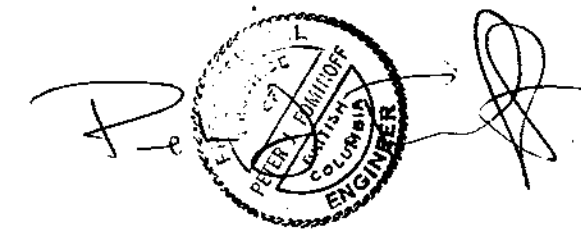

TO ACCOMPANY A GEOPHYSICAL REPORT BY
MICHAEL J. LEWIS AND P.J. FOMINOFF
DATED: 27. OCTOBER 1972

WORK COMPLETED: 28.9.1972
DRAFTED: 25.10.1972 at
REV.

JOB NUMBER
889

SHEET NUMBER
1 OF 1