

GEOLOGICAL BRANCH  
ASSESSMENT REPORT

**12,911** PART 2  
OF 2

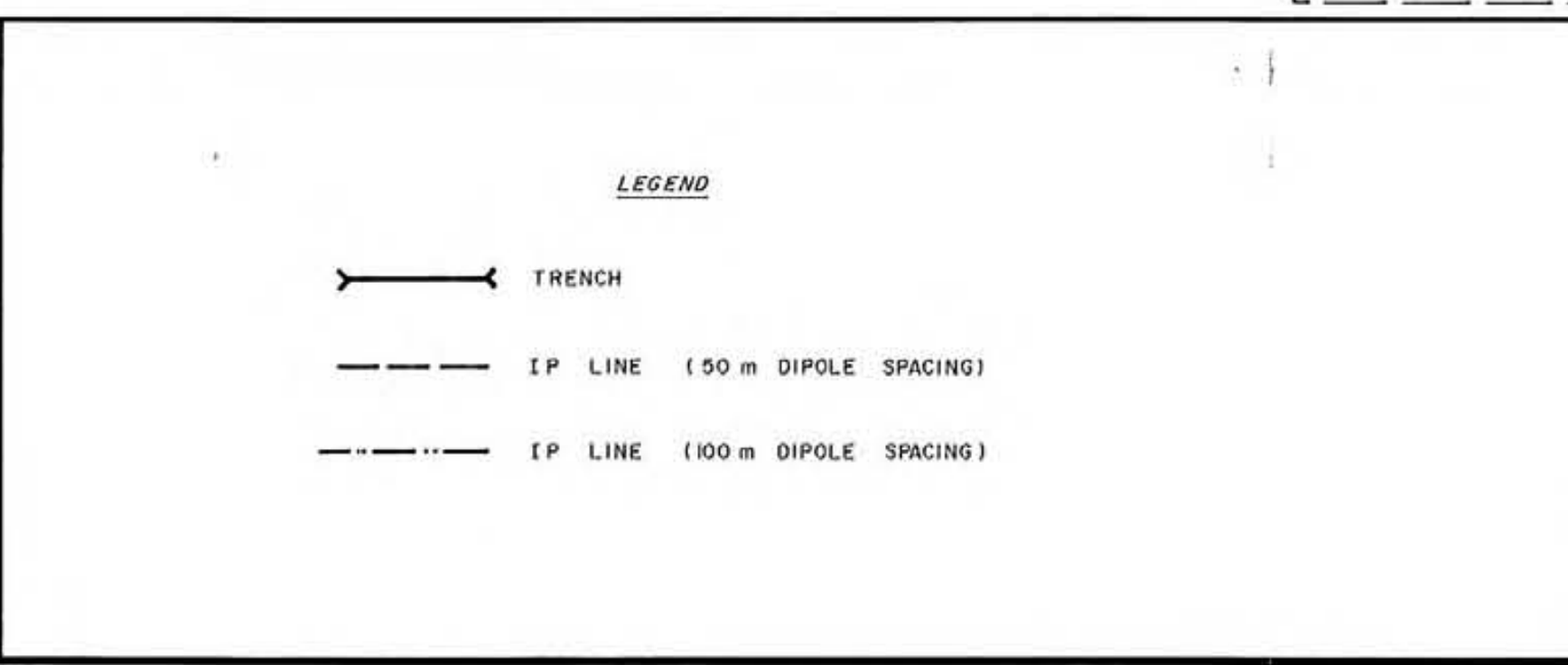
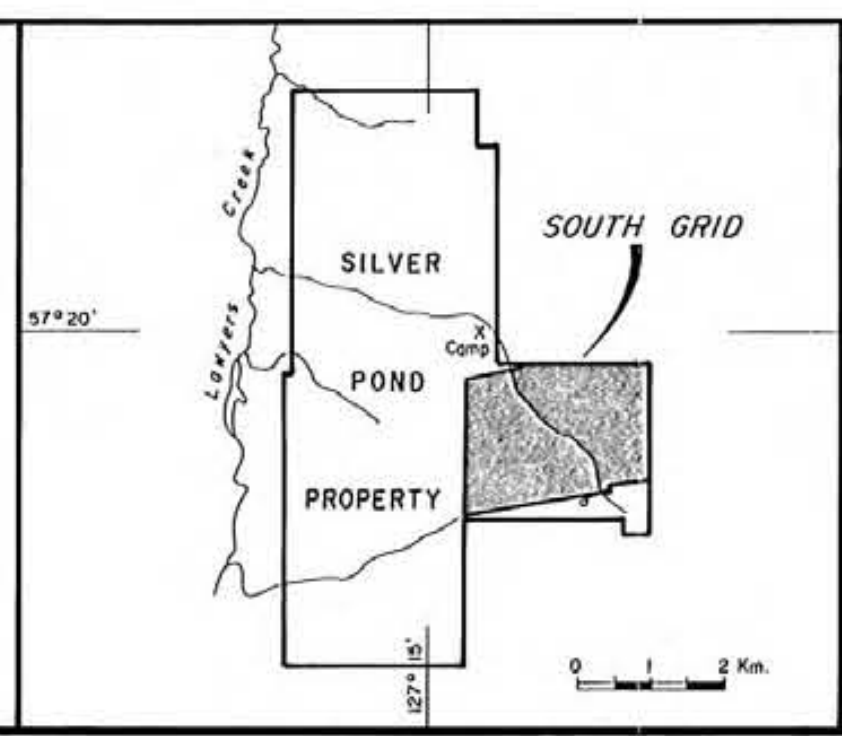
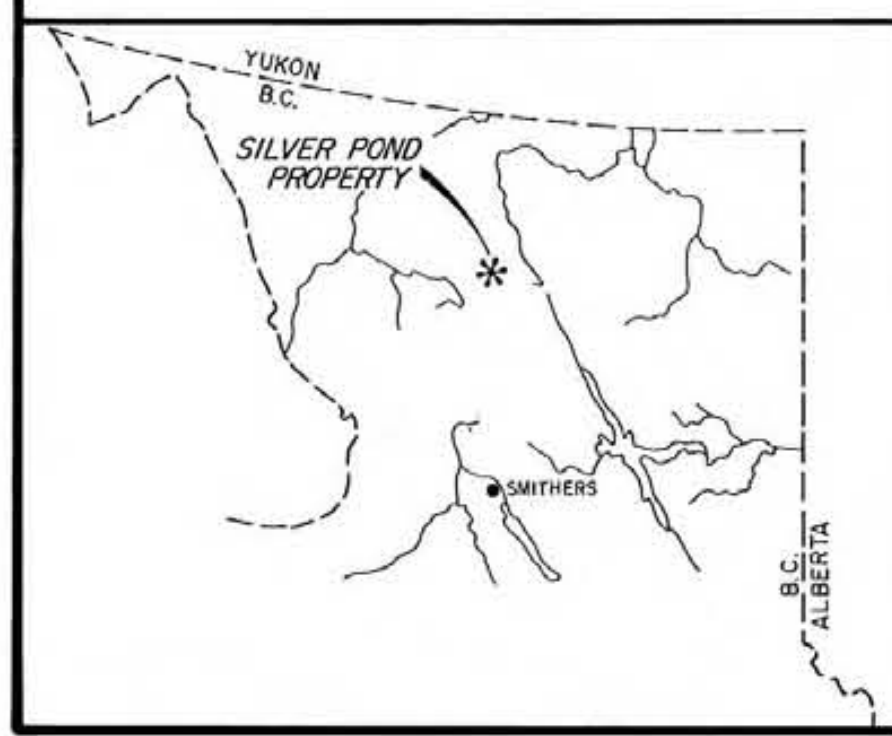

ST. JOE CANADA INC.  
SILVER POND PROPERTY  
SOUTH GRID  
LOCATION MAP  
(I.P. LINES, TRENCHES, SOIL SAMPLES)

SCALE 1:5000  
Metres 0 50 100 200 300 400 500

PLAN No:	DRAWN BY: D.K.	DATE BY:	FIGURE No:
		NTS 94E/6E	18



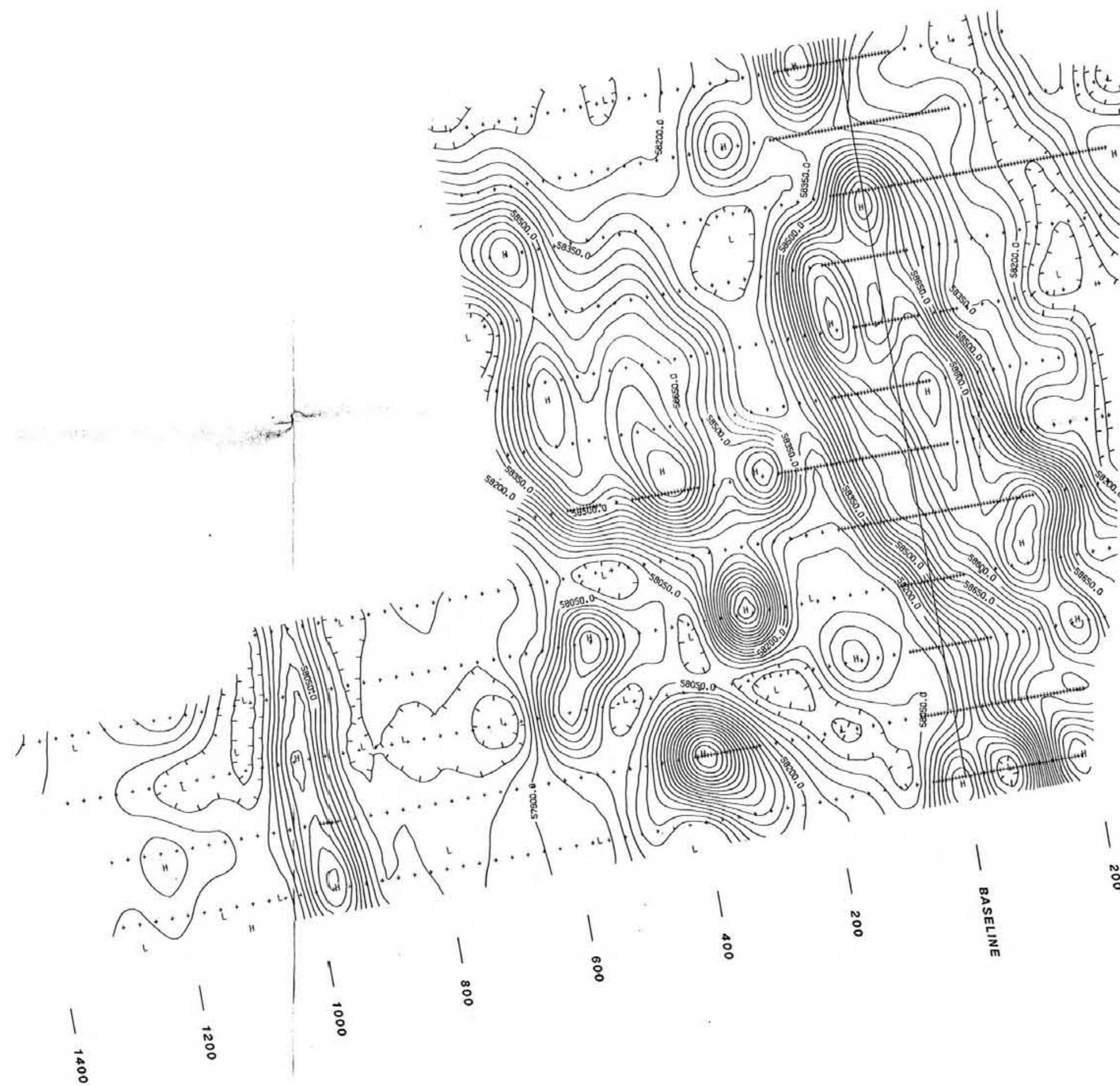

LINE 9 N  
 LINE 8 N  
 LINE 7 N  
 LINE 6 N  
 LINE 5 N  
 LINE 4 N  
 LINE 3 N  
 LINE 2 N  
 LINE 1 N  
 LINE 0  
 LINE 1 S  
 LINE 2 S

CONTOUR INTERVAL: 50 gammas

GEOLOGICAL BRANCH  
ASSESSMENT REPORT

12,911 PART 2 OF 2

TOTAL INTENSITY  
MAGNETIC CONTOUR PLAN

SOUTH GRID

SILVER POND PROJECT  
Toodoggone District, British Columbia

ST JOE CANADA, INC.

SCALE: 1:5000 JULY 1984

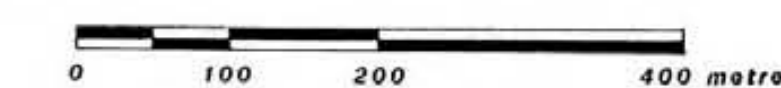

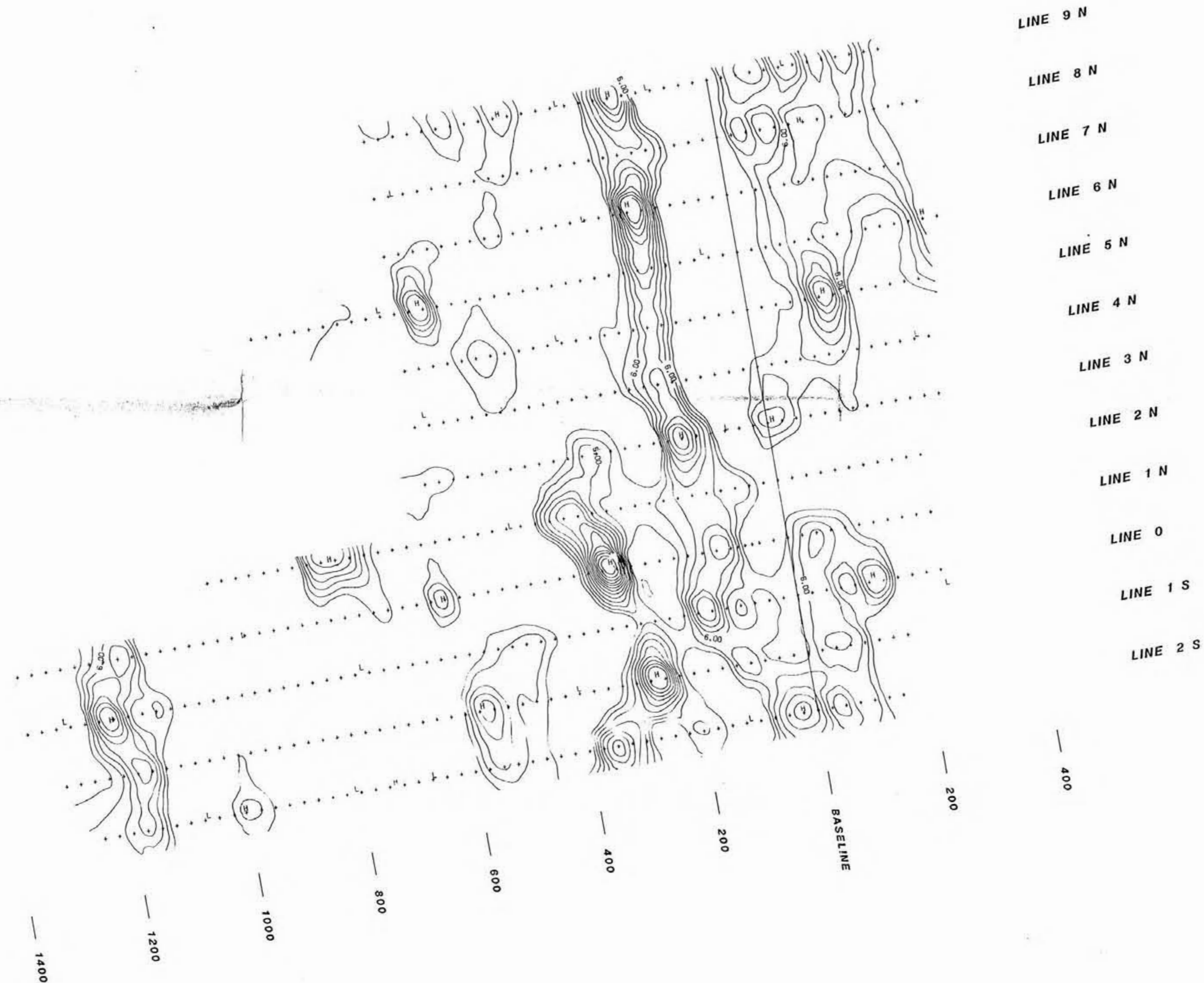

CONTOUR INTERVAL: 2 units  
 TRANSMITTER STATION USED: Seattle

GEOLOGICAL BRANCH  
 ASSESSMENT REPORT

**12,911** PART 2 OF 2  
 FRASER FILTERED  
 VLF-EM CONTOUR PLAN

SOUTH GRID

SILVER POND PROJECT  
 Toodoggone District, British Columbia

ST JOE CANADA, INC.

SCALE: 1:5000 AUGUST 1984

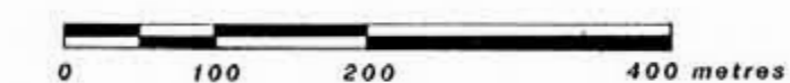



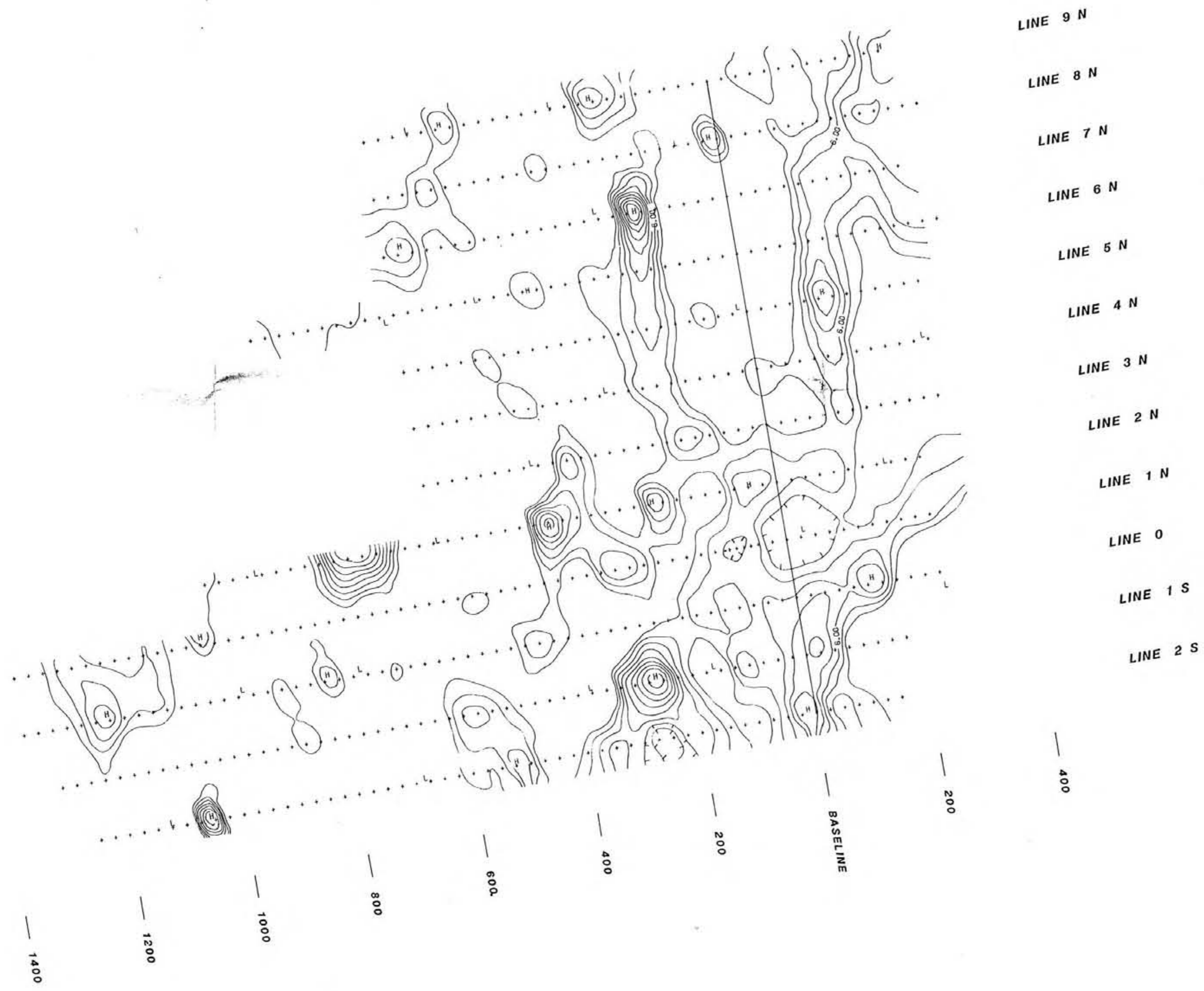

CONTOUR INTERVAL: 2 units  
 TRANSMITTER STATION USED: Hawaii

↑  
N

GEOLOGICAL BRANCH  
 ASSESSMENT REPORT

# 12,911

PART 2 OF 2  
 FRASER FILTERED  
 VLF-EM CONTOUR PLAN

SOUTH GRID

SILVER POND PROJECT  
 Toodoggone District, British Columbia

ST JOE CANADA, INC.

SCALE: 1:5000    AUGUST 1984

0    100    200    400 metres



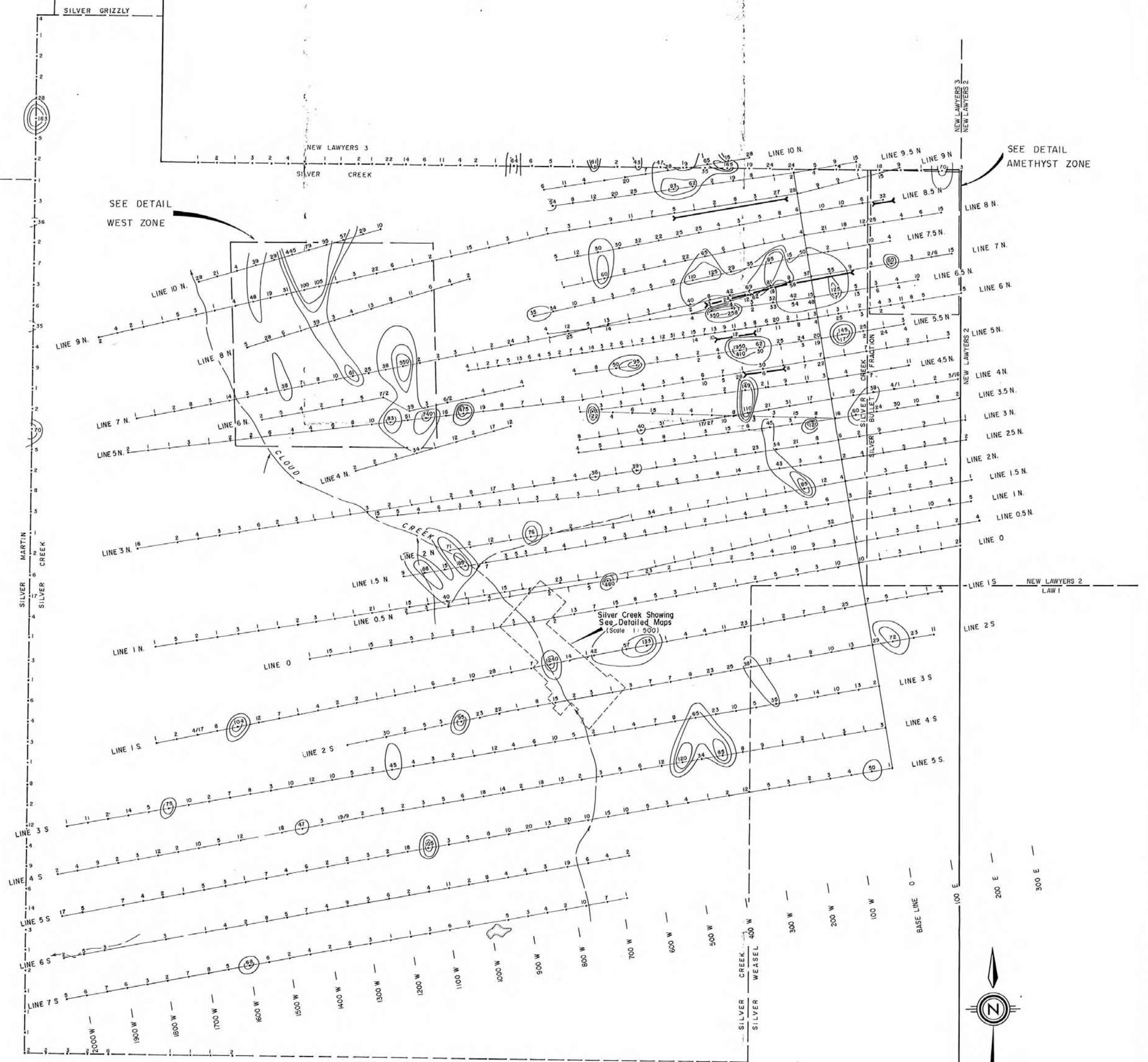

SEE DETAIL  
AMETHYST ZONE

SEE DETAIL  
WEST ZONE

GEOLOGICAL BRANCH  
ASSESSMENT REPORT

**12,911**  
PART 2 OF 2

ST. JOE CANADA INC.

**SILVER POND PROPERTY  
SOUTH GRID  
SOIL GEOCHEMICAL SURVEY  
GOLD IN PPB**

SCALE 1:5000  
Metres 0 50 100 200 300 400 500

PLAN No:	DRAWN BY: A.W.	DATE: NOVEMBER 1984 NTS 94E/6E	FIGURE No: 22
----------	-------------------	---	------------------

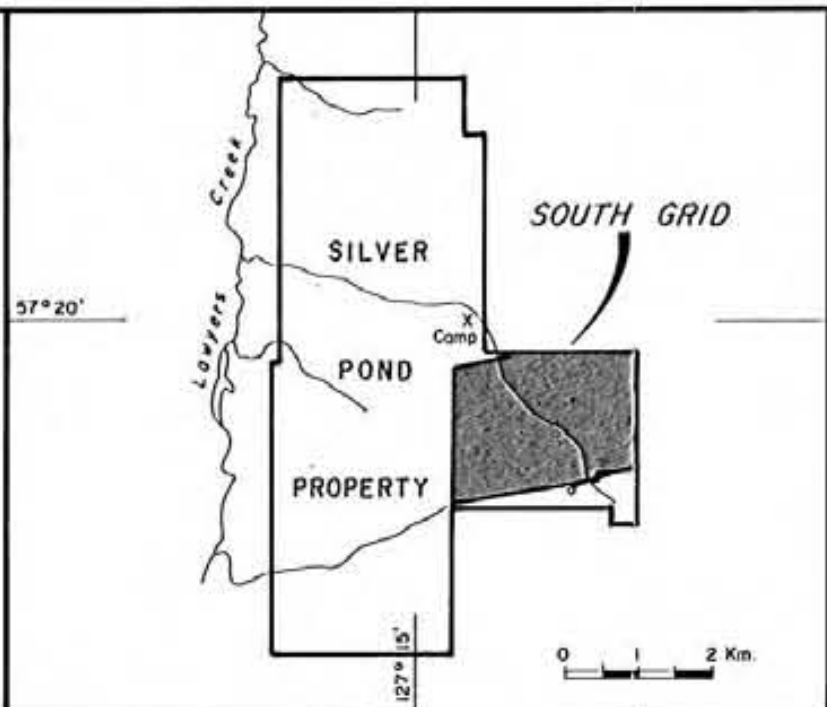
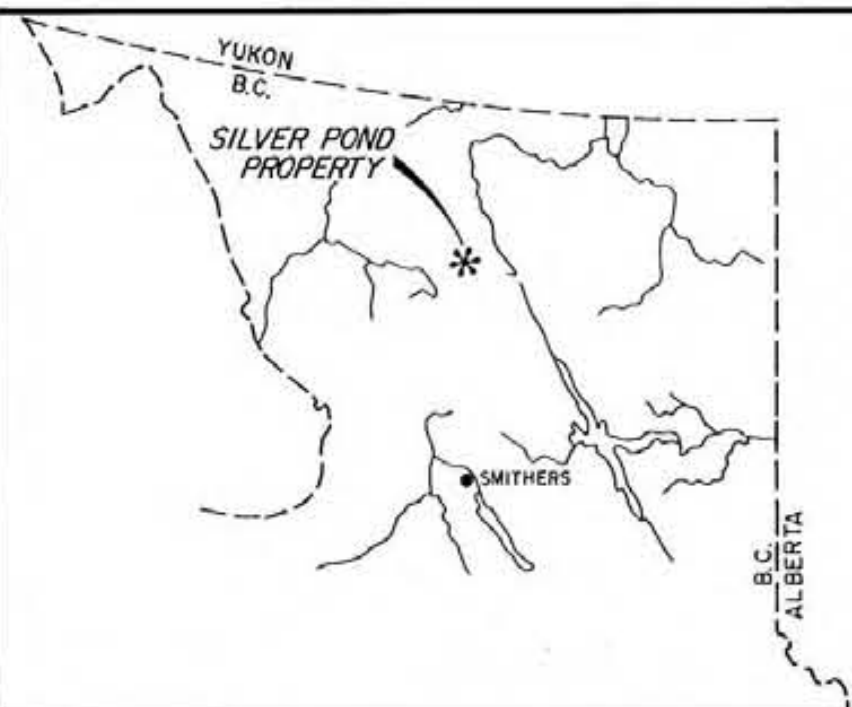

**LEGEND**

- $\frac{4}{6}$  RESAMPLES - SAME LOCATION
- 19/9 DUPLICATE SAMPLES (MISLABELLED?)
- TRENCH

**STATISTICS**

N = 1033 - 10 (OUTLIERS) (2258 ppb)  
 $\bar{X}$  (MEAN) = 12.53  
 $\bar{X} + S$  = 34.32 34  
 $\bar{X} + 2s$  = 56.11 56  
 $\bar{X} + 3s$  = 77.9 78  
 } CONTOURS  
 S (STANDARD DEVIATION) = 21.79



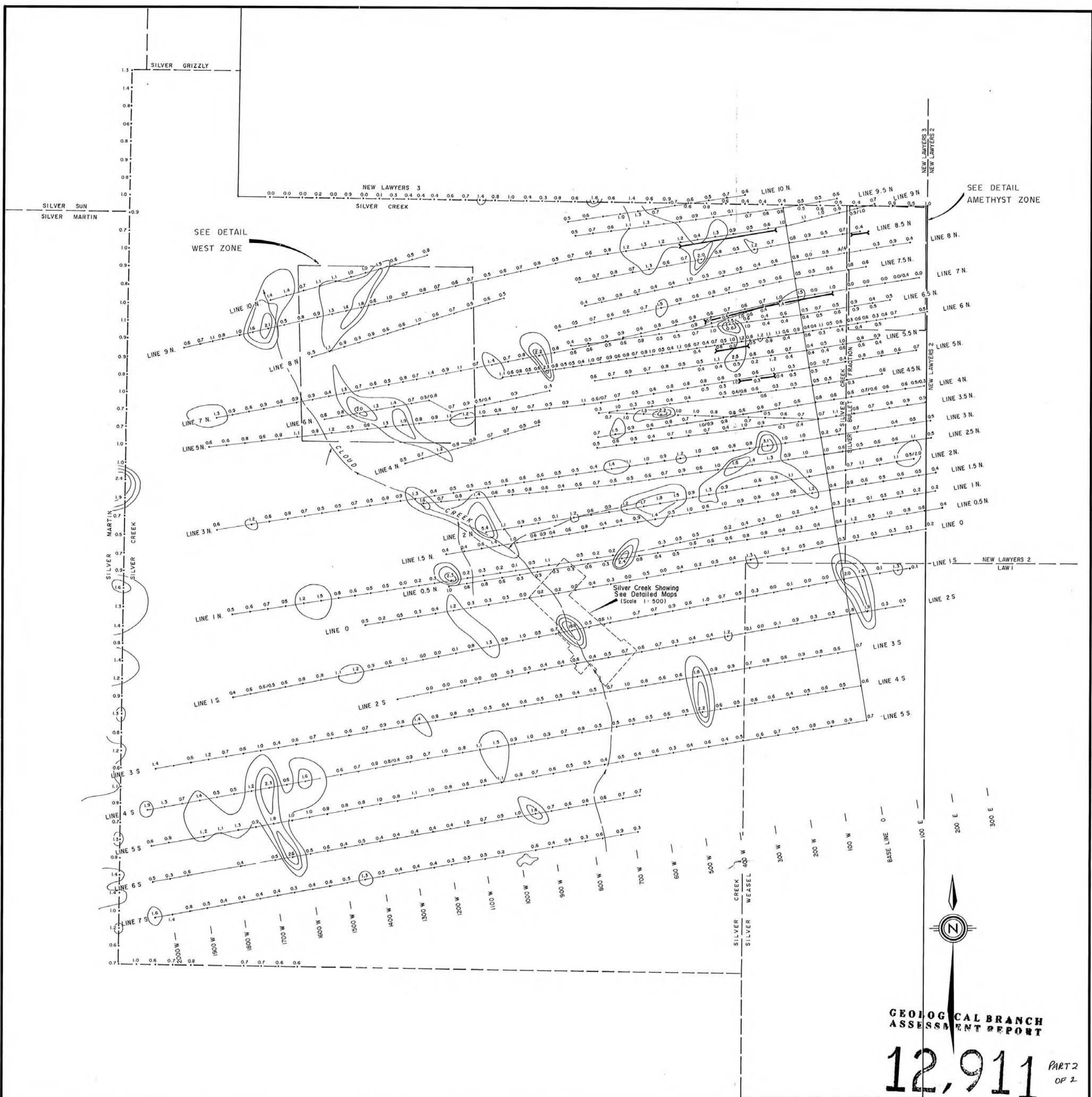

GEOLOGICAL BRANCH  
ASSESSMENT REPORT

**12,911** PART 2  
OF 2

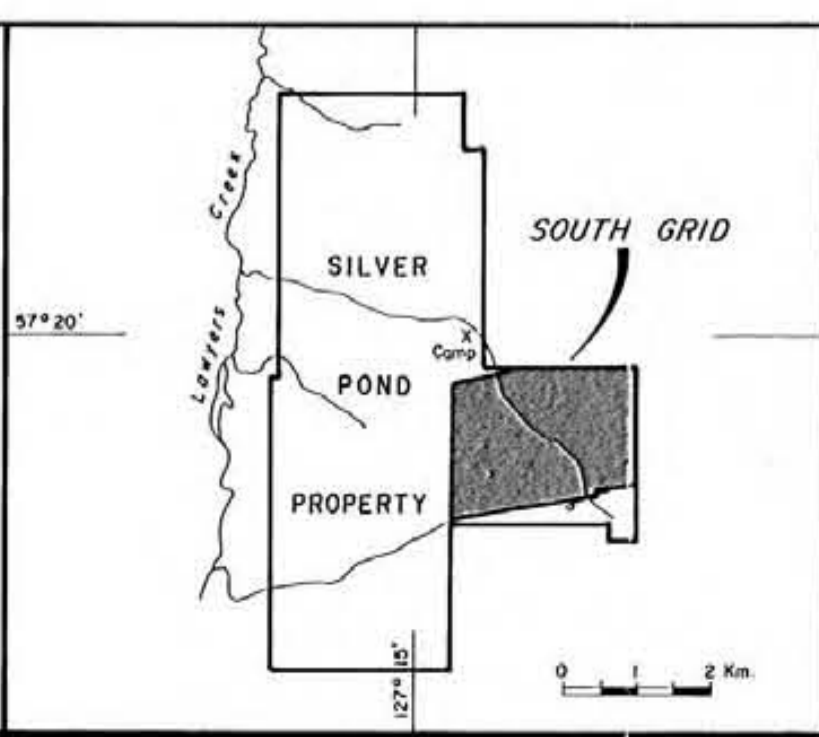
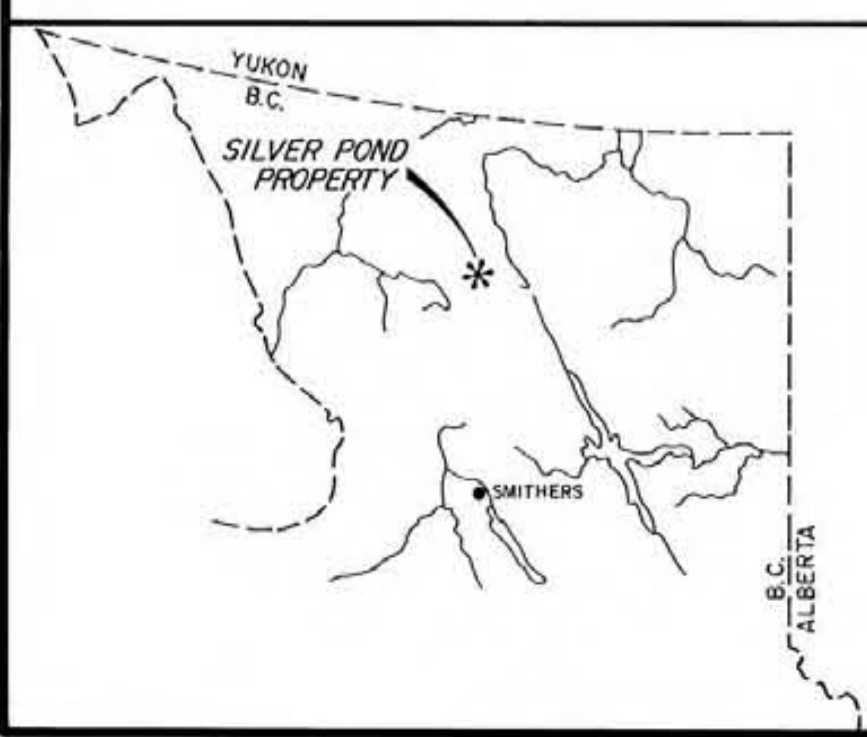

LEGEND		STATISTICS	
$\frac{1.1}{0.8}$	RESAMPLES - SAME LOCATION	N	= 1031 - 4 (OUTLIERS) (2.3 ppm)
1.0/0.9	DUPLICATE SAMPLES (MISLABELLED?)	$\bar{X}$ (MEAN)	= .713 ppm
$\longleftarrow$	TRENCH	$\bar{X} + S$	= 1.094 $\approx$ 1.1
		$\bar{X} + 2s$	= 1.475 $\approx$ 1.5
		$\bar{X} + 3s$	= 1.856 $\approx$ 1.9
		S (STANDARD DEVIATION)	= .381

ST. JOE CANADA INC.			
SILVER POND PROPERTY			
SOUTH GRID			
SOIL GEOCHEMICAL SURVEY			
SILVER IN PPM			
SCALE 1:5000			
Metres 0 50 100 200 300 400 500			
PLAN No:	DRAWN BY: A.W.	DATE: NOVEMBER 1984	FIGURE No:
		NTS 94E/6E	23

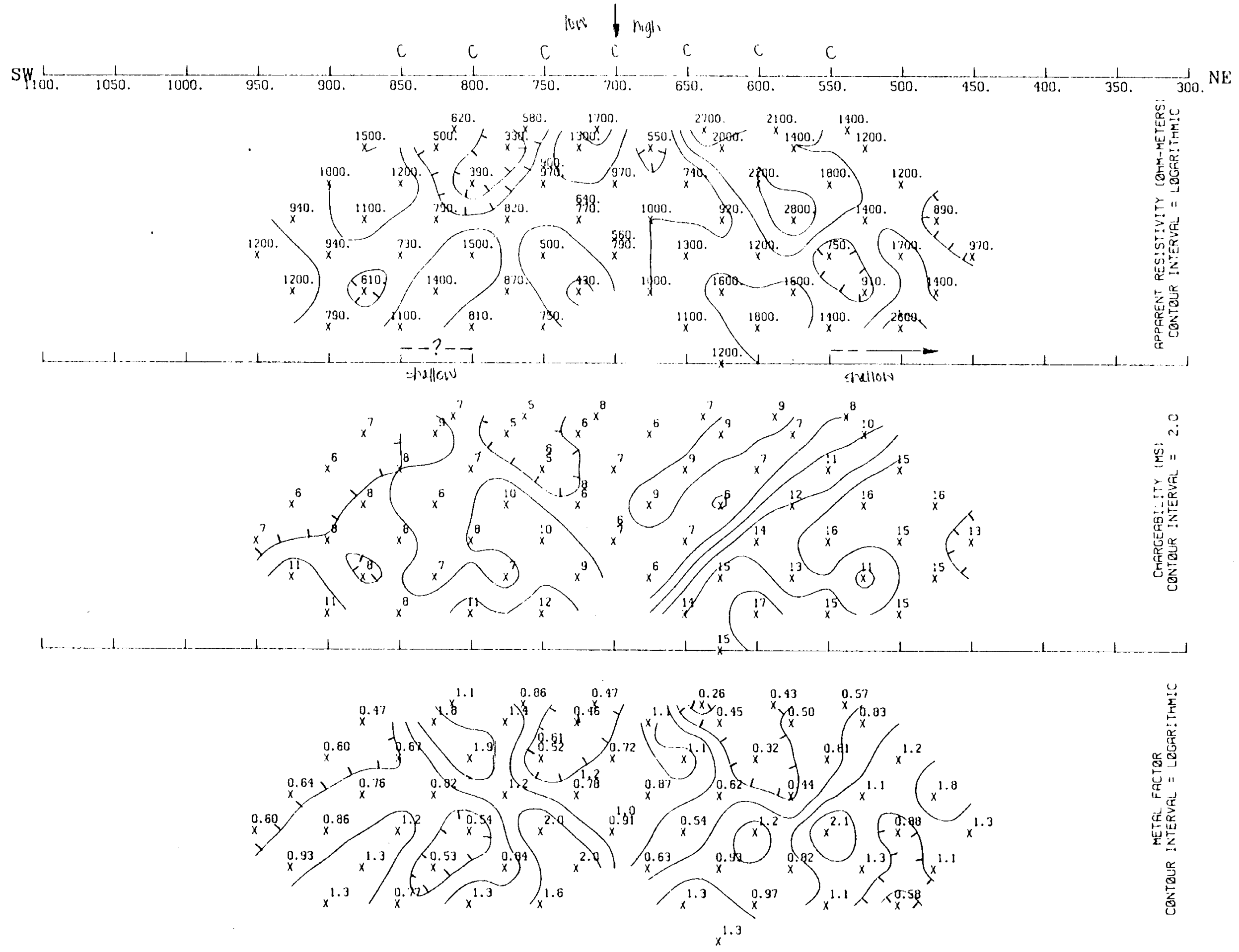

LINE 1 S  
 INDUCED POLARIZATION PROFILE  
 SILVER POND PROJECT  
 SOUTH GRID  
 TOODOGGONE DISTRICT  
 BRITISH COLUMBIA  
 ST. JOE AMERICAN CORPORATION  
 BEARING N80E  
 JULY 1984  
 DIPOLE SPACING = 50.0 METERS  
 FIGURE 24

GEOLOGICAL BRANCH  
 ASSESSMENT REPORT

12,911  
 PART 2 OF 2



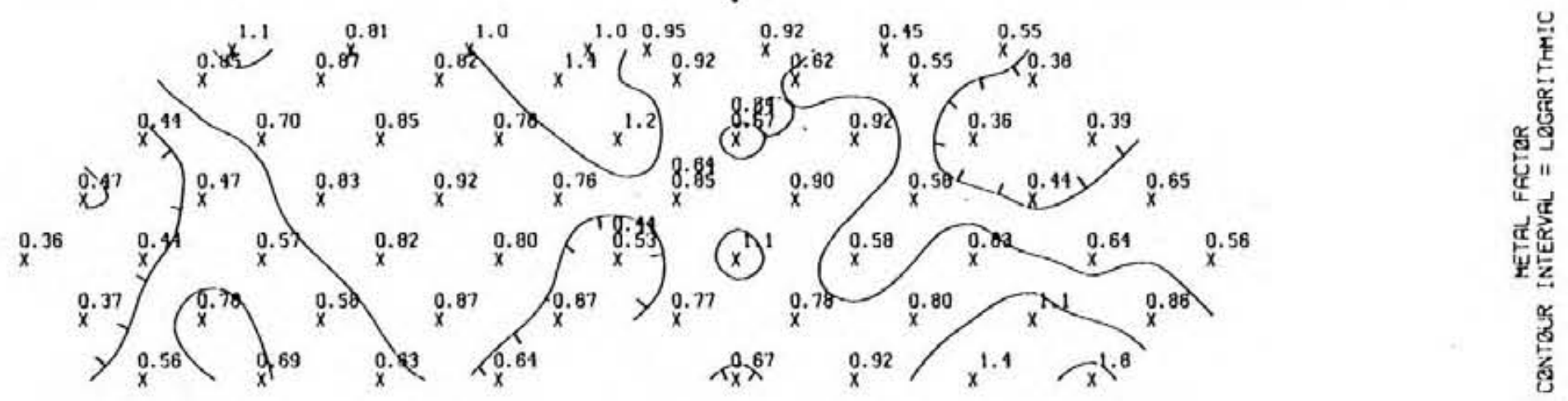
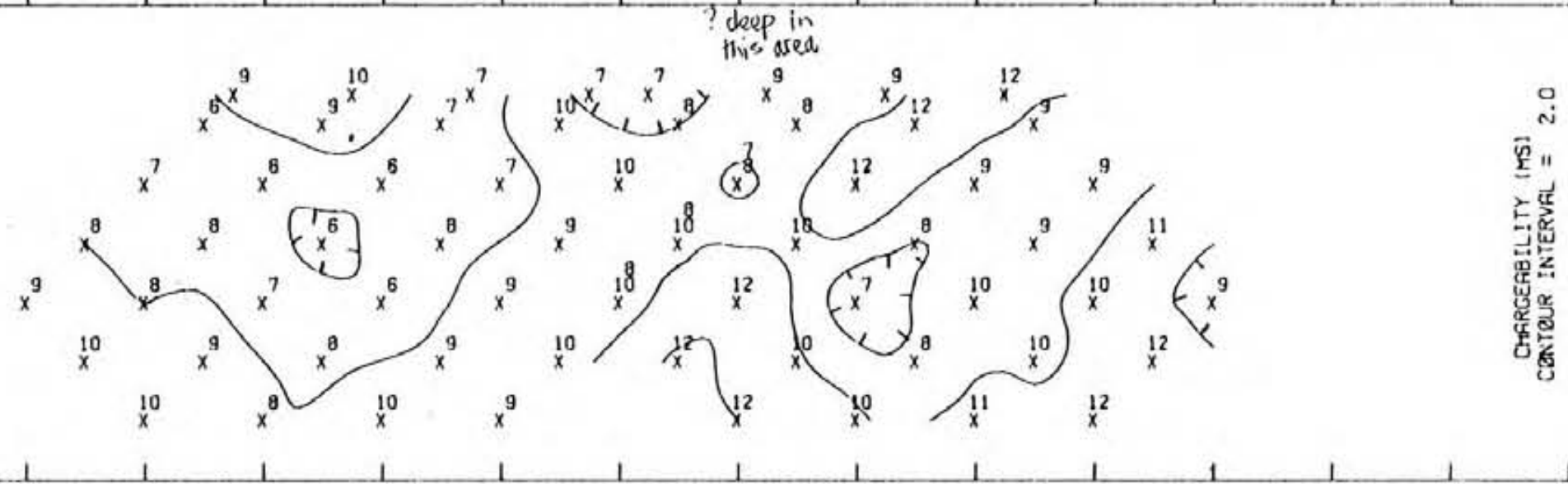
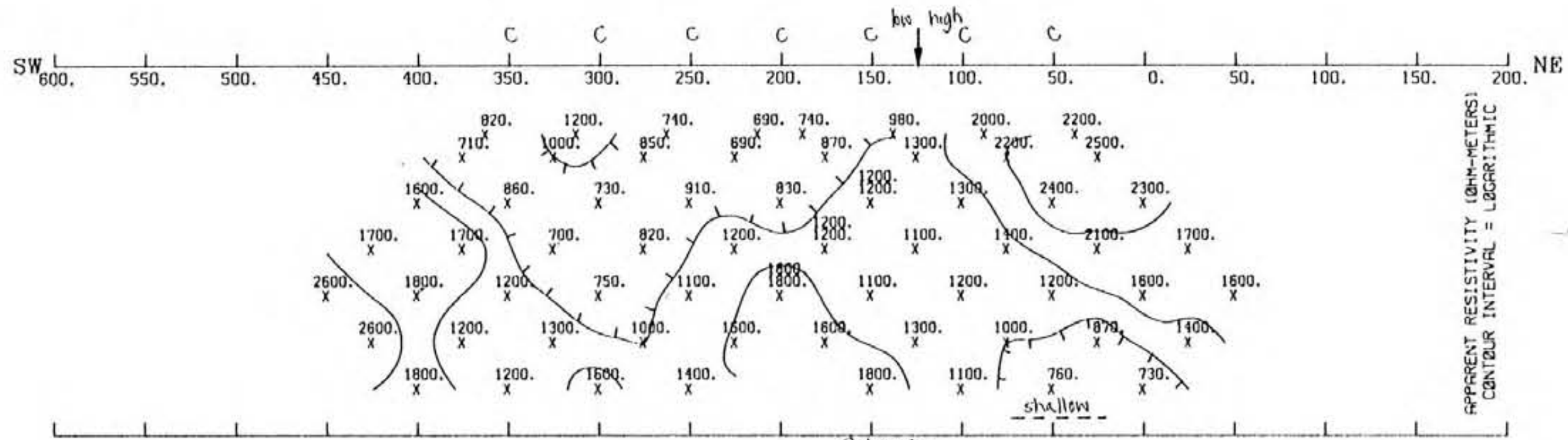

**LINE 4.5 N**  
**INDUCED POLARIZATION PROFILE**  
**SILVER POND PROJECT**  
**SOUTH GRID**  
**TOODOGGONE DISTRICT**  
**BRITISH COLUMBIA**  
**ST. JOE AMERICAN CORPORATION**  
**BEARING N80E**  
**JUNE 1984**  
**DIPOLE SPACING = 50.0 METERS**

FIGURE 25

**GEOLOGICAL BRANCH**  
**ASSESSMENT REPORT**

12,911

PART 2 OF 2



SW 800. 750. 700. 650. 600. 550. 500. 450. 400. 350. 300. 250. 200. 150. 100. 50. 0. 50. 100. 150. 200. 250. 300. 350. NE

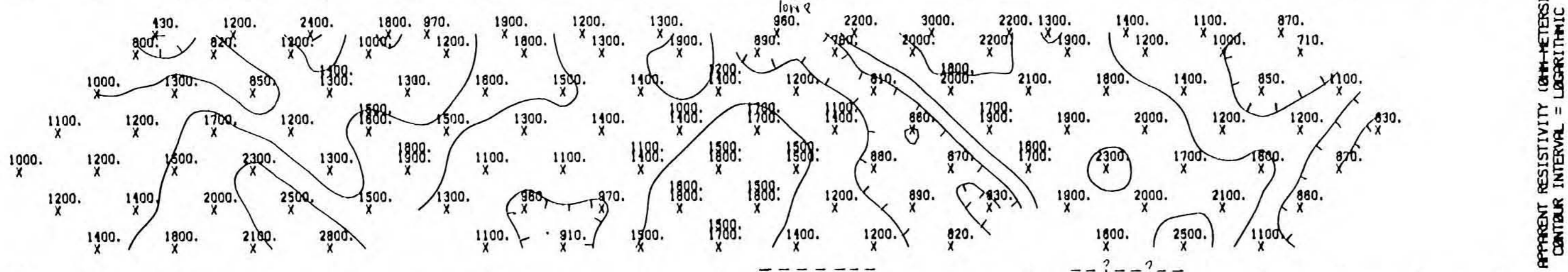

APPARENT RESISTIVITY (OHM-METERS)  
CONTOUR INTERVAL = LOGARITHMIC

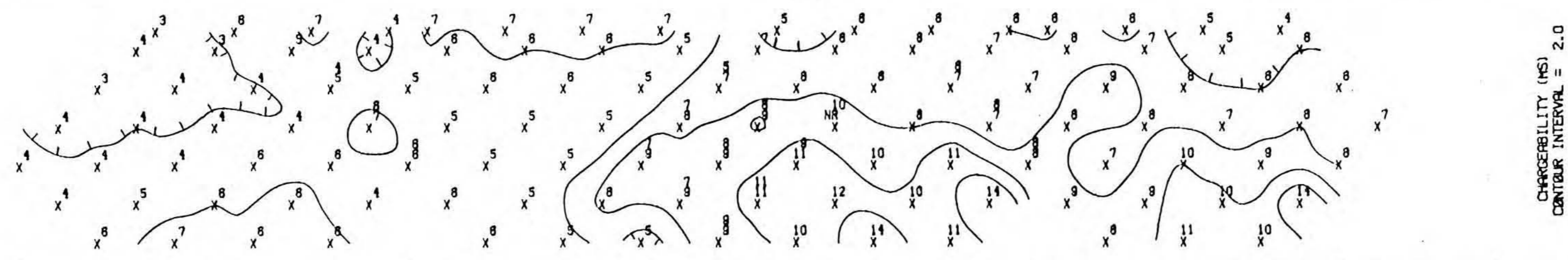

CHARGEABILITY (MS)  
CONTOUR INTERVAL = 2.0

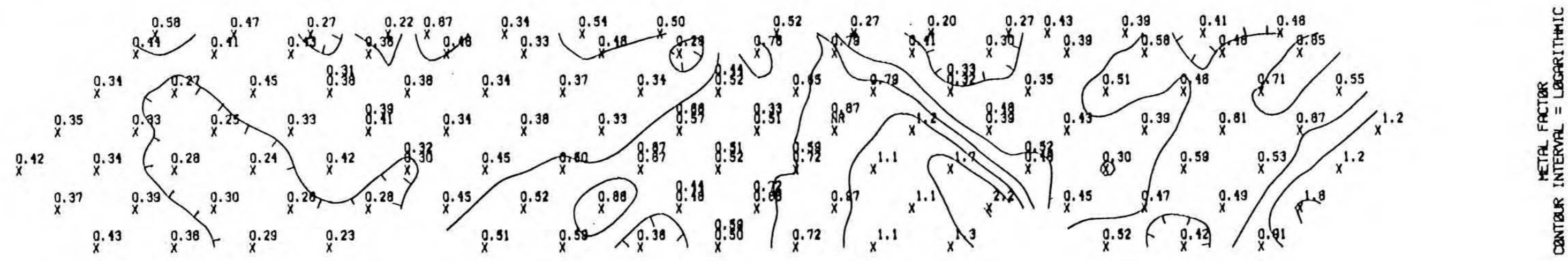

METAL FACTOR  
CONTOUR INTERVAL = LOGARITHMIC

LINE 6 N  
INDUCED POLARIZATION PROFILE  
SILVER POND PROJECT  
SOUTH GRID  
TOODOGGONE DISTRICT  
BRITISH COLUMBIA  
ST. JOE AMERICAN CORPORATION  
BEARING N80E  
JUNE 1984  
DIPOLE SPACING = 50.0 METERS  
FIGURE 26

GEOLOGICAL BRANCH  
ASSESSMENT REPORT

12,911

PART 2 OF 2

SW 550. 500. 450. 400. 350. 300. 250. 200. 150. 100. 50. 0. 50. 100. 150. 200. NE

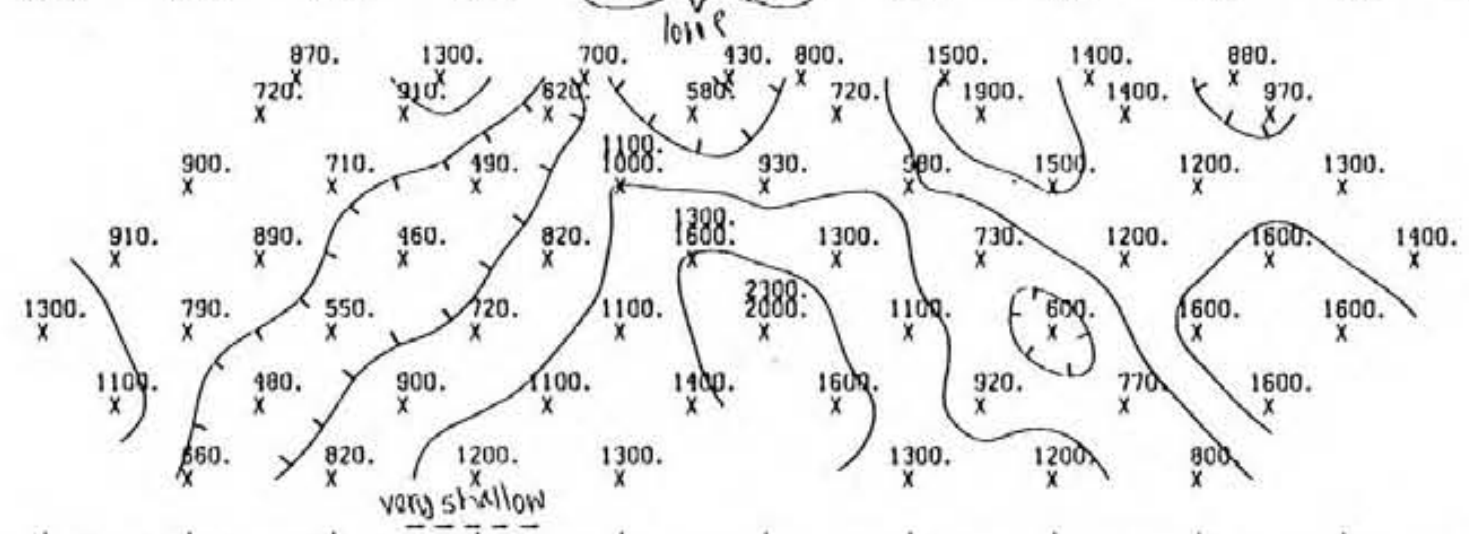

APPARENT RESISTIVITY (OHM-METERS)  
CONTOUR INTERVAL = LOGARITHMIC

~ 75 m deep

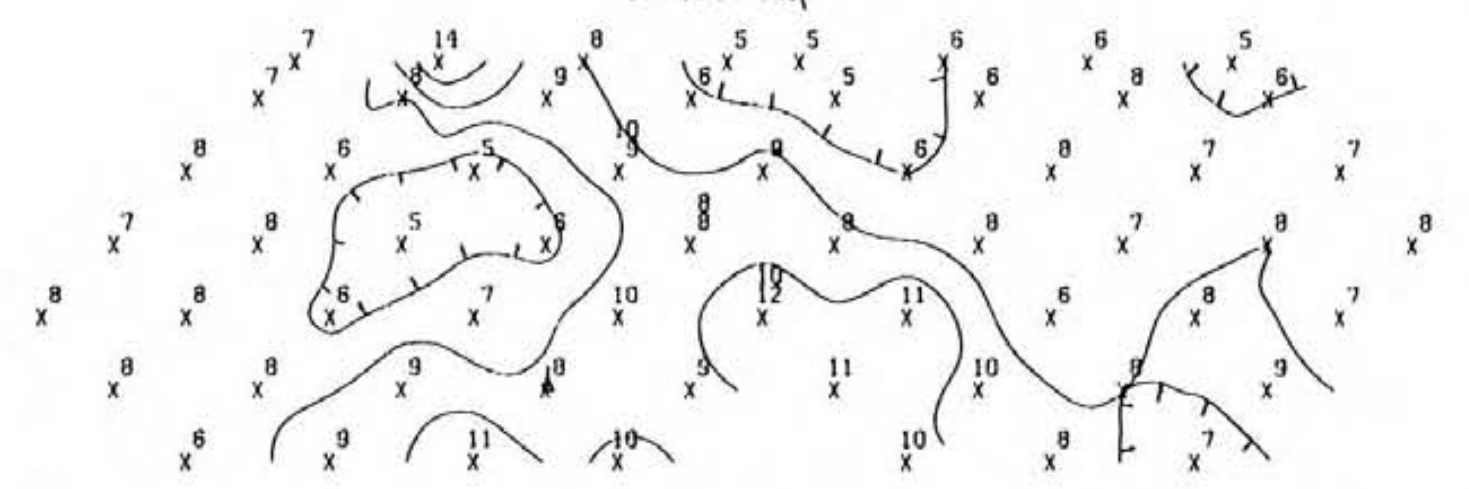

CHARGEABILITY (MS)  
CONTOUR INTERVAL = 2.0

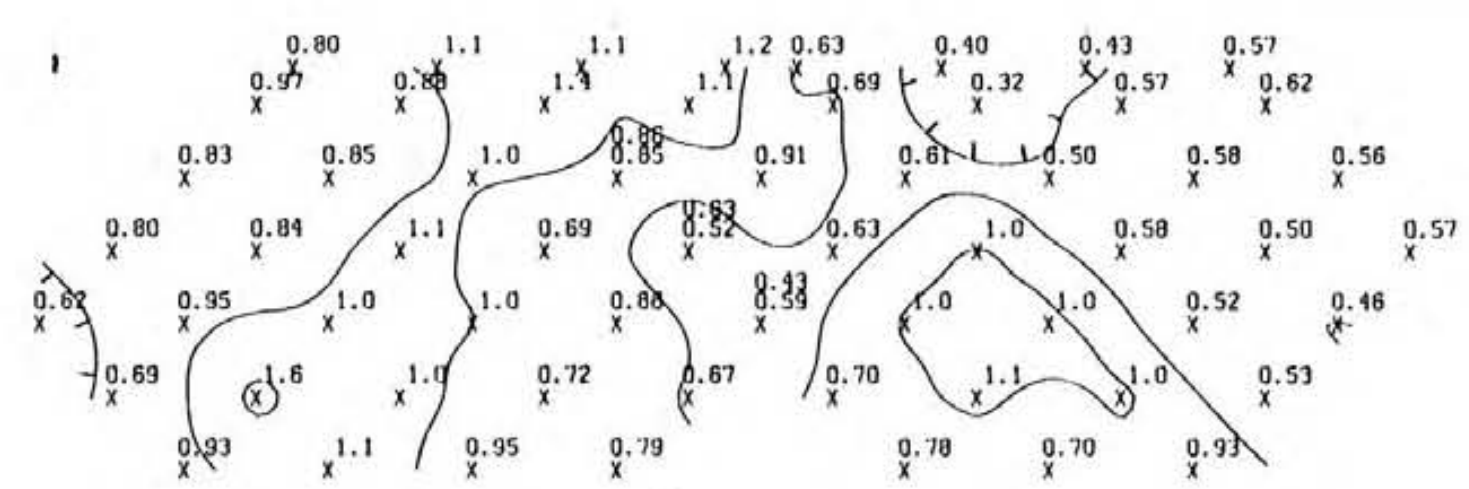

METAL FACTOR  
CONTOUR INTERVAL = LOGARITHMIC

LINE 9 N  
INDUCED POLARIZATION PROFILE  
SILVER POND PROJECT  
SOUTH GRID  
TOODOGGONE DISTRICT  
BRITISH COLUMBIA  
ST. JOE AMERICAN CORPORATION  
BEARING N80E  
JULY 1984  
DIPOLE SPACING = 50.0 METERS  
FIGURE 27

GEOLOGICAL BRANCH  
ASSESSMENT REPORT

12,911

PART 2 OF 2



SW 1000. 900. 800. 700. 600. 500. 400. 300. 200. 100. 0. 100. 200. 300. 400. 500. 600. NE

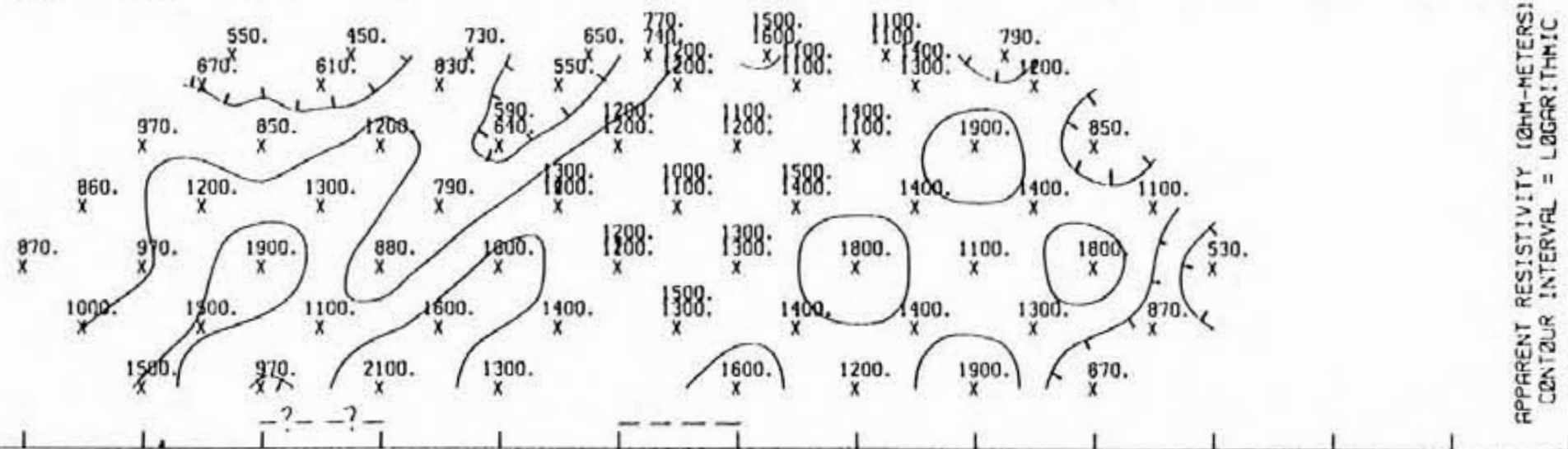

APPARENT RESISTIVITY (OHM-METERS)  
CONTOUR INTERVAL = LOGARITHMIC

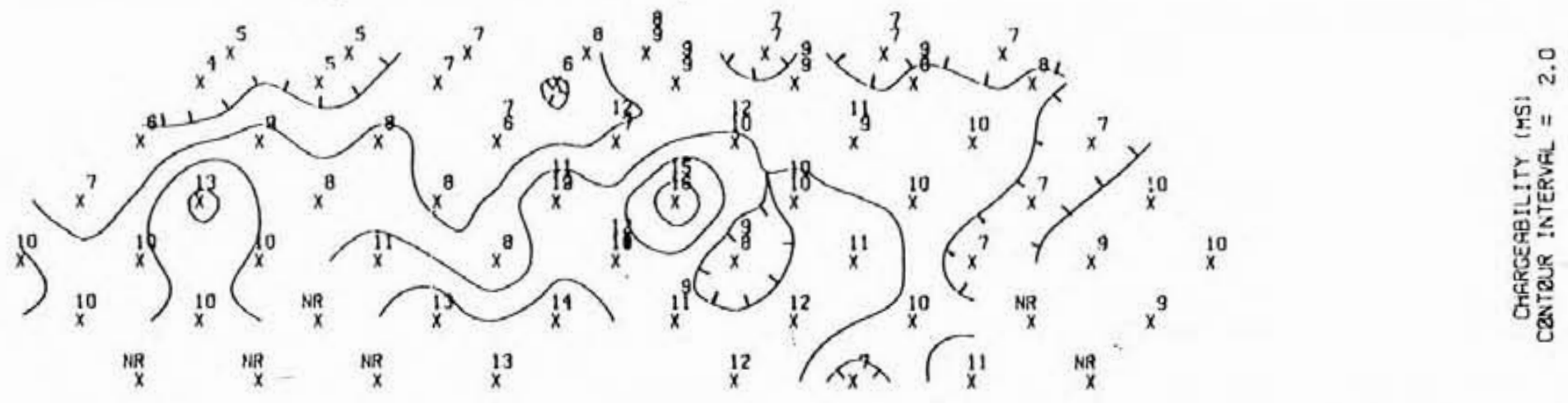

CHARGEABILITY (MS)  
CONTOUR INTERVAL = 2.0

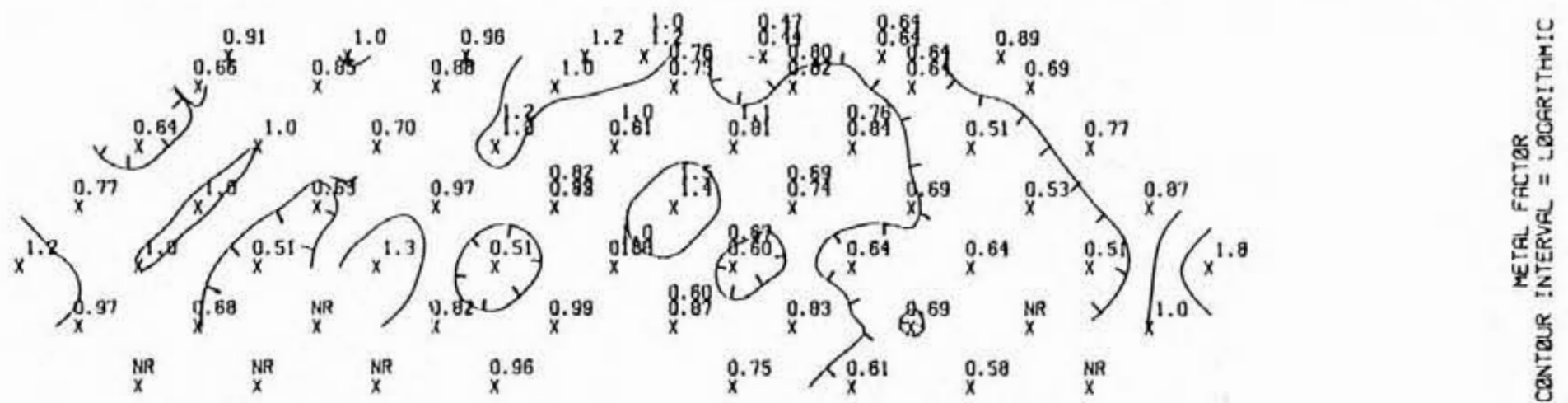

METAL FACTOR  
CONTOUR INTERVAL = LOGARITHMIC

LINE 9 N  
INDUCED POLARIZATION PROFILE  
SILVER POND PROJECT  
SOUTH GRID  
TOODOGGONE DISTRICT  
BRITISH COLUMBIA  
ST. JOE AMERICAN CORPORATION  
BEARING N80E  
JULY 1984  
DIPOLE SPACING = 100.0 METERS  
FIGURE 28

GEOLOGICAL BRANCH  
ASSESSMENT REPORT

12,911  
PART 2 OF 2

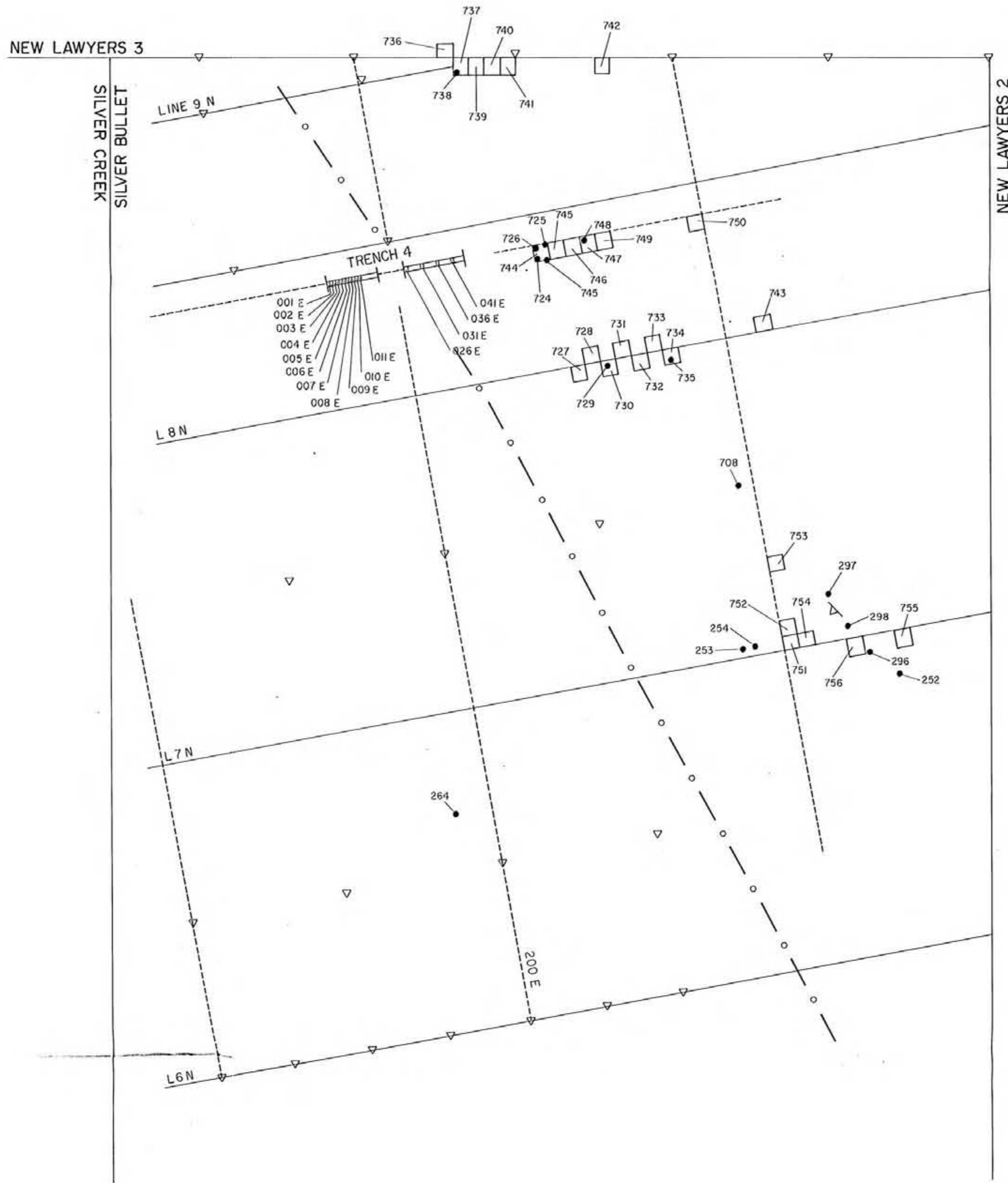

**GEOLOGICAL BRANCH  
ASSESSMENT REPORT**

**12,911**

PART 2 OF 2

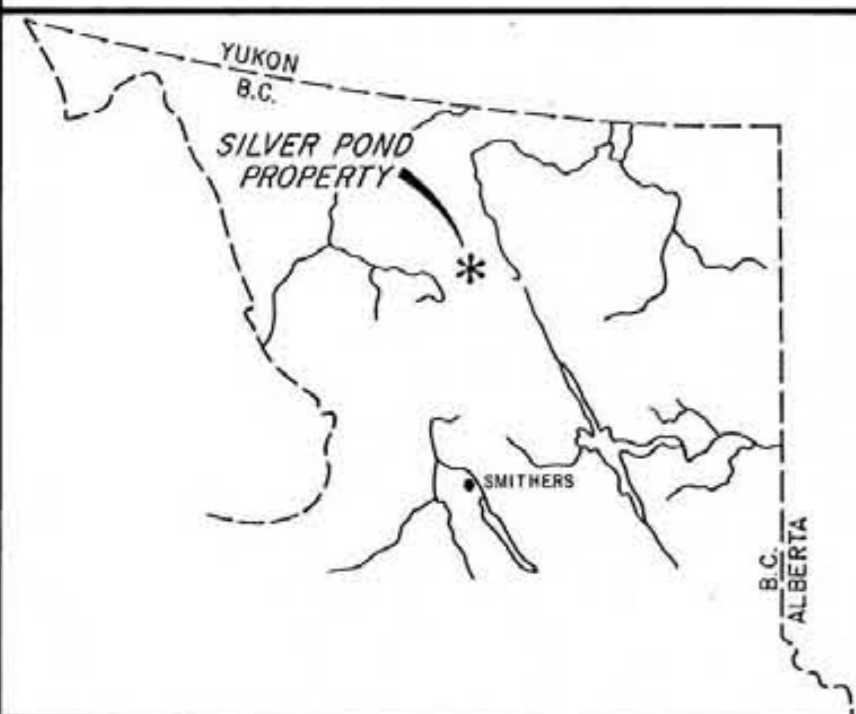

**LEGEND**

- Talus Panel Sample (5 x 5 m)
- Grab Sample
- ▽ Soil Sample, Au (ppb)
- Trend of Magnetic Low
- F Float
- Amethyst
- c Chalcedony

ST. JOE CANADA INC.  
SILVER POND PROPERTY  
AMETHYST ZONE  
**SAMPLE NUMBERS**

SCALE 1:1000  
Metres 0 10 20 40 60 80 100

PLAN No:	DRAWN BY: A.V.	DATE: NOVEMBER 1984 NTS 94E / 6E	FIGURE No: 29
----------	-------------------	--	------------------



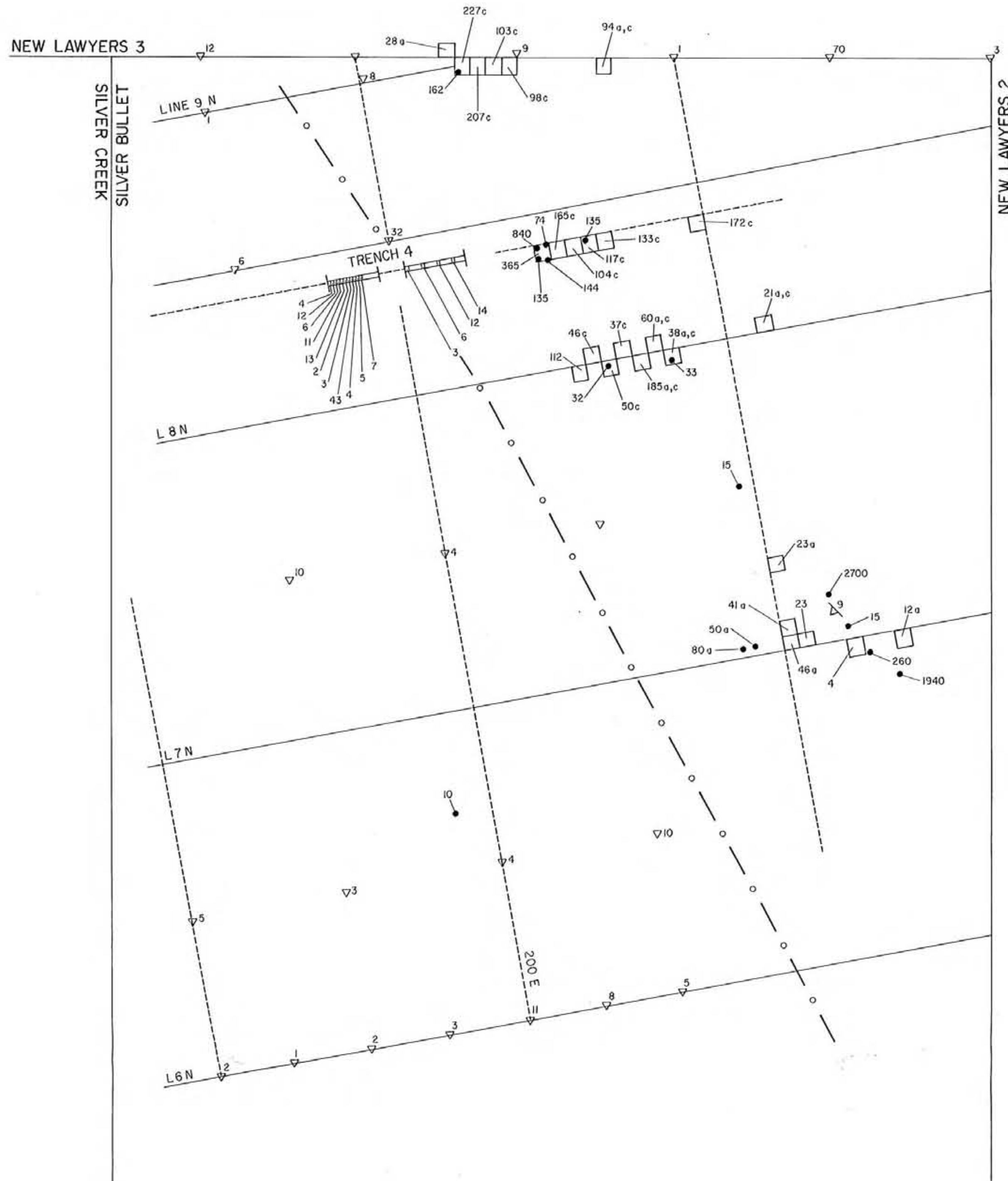

**GEOLOGICAL BRANCH  
ASSESSMENT REPORT**

**12,911**

PART 2 OF 2

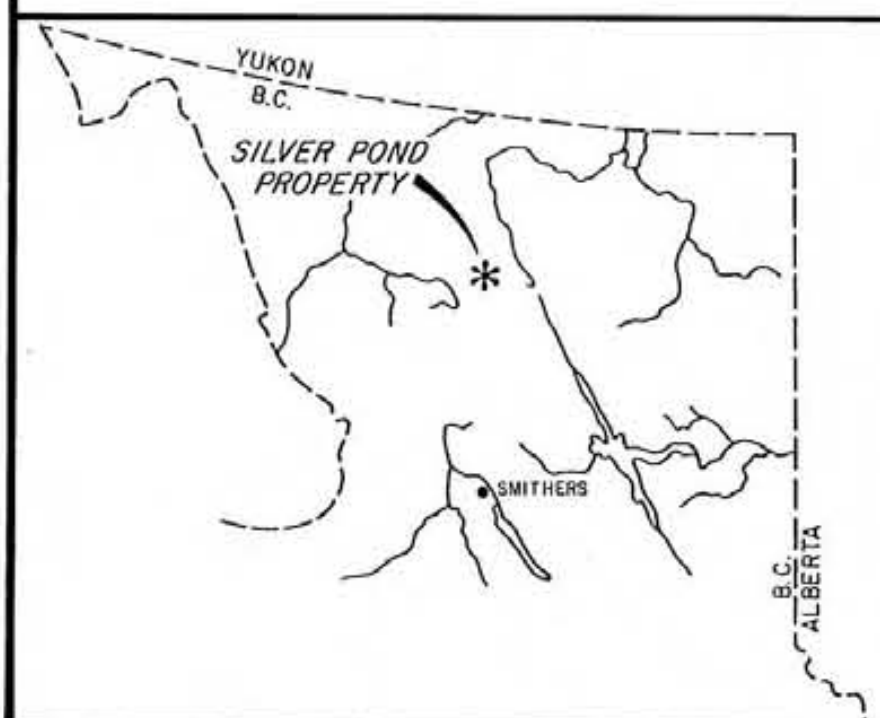

**LEGEND**

- Talus Panel Sample (5x5 m)
- Grab Sample
- ▽ Soil Sample, Au (ppb)
- Trend of Magnetic Low
- F Float
- a Amethyst
- c Chalcedony

ST. JOE CANADA INC.			
SILVER POND PROPERTY			
AMETHYST ZONE			
GOLD (ppb)			
SCALE 1:1000			
Metres 0 10 20 40 60 80 100			
PLAN No:	DRAWN BY: A. V.	DATE: NOVEMBER 1984	FIGURE No: 30
		NTS 94E/6E.	

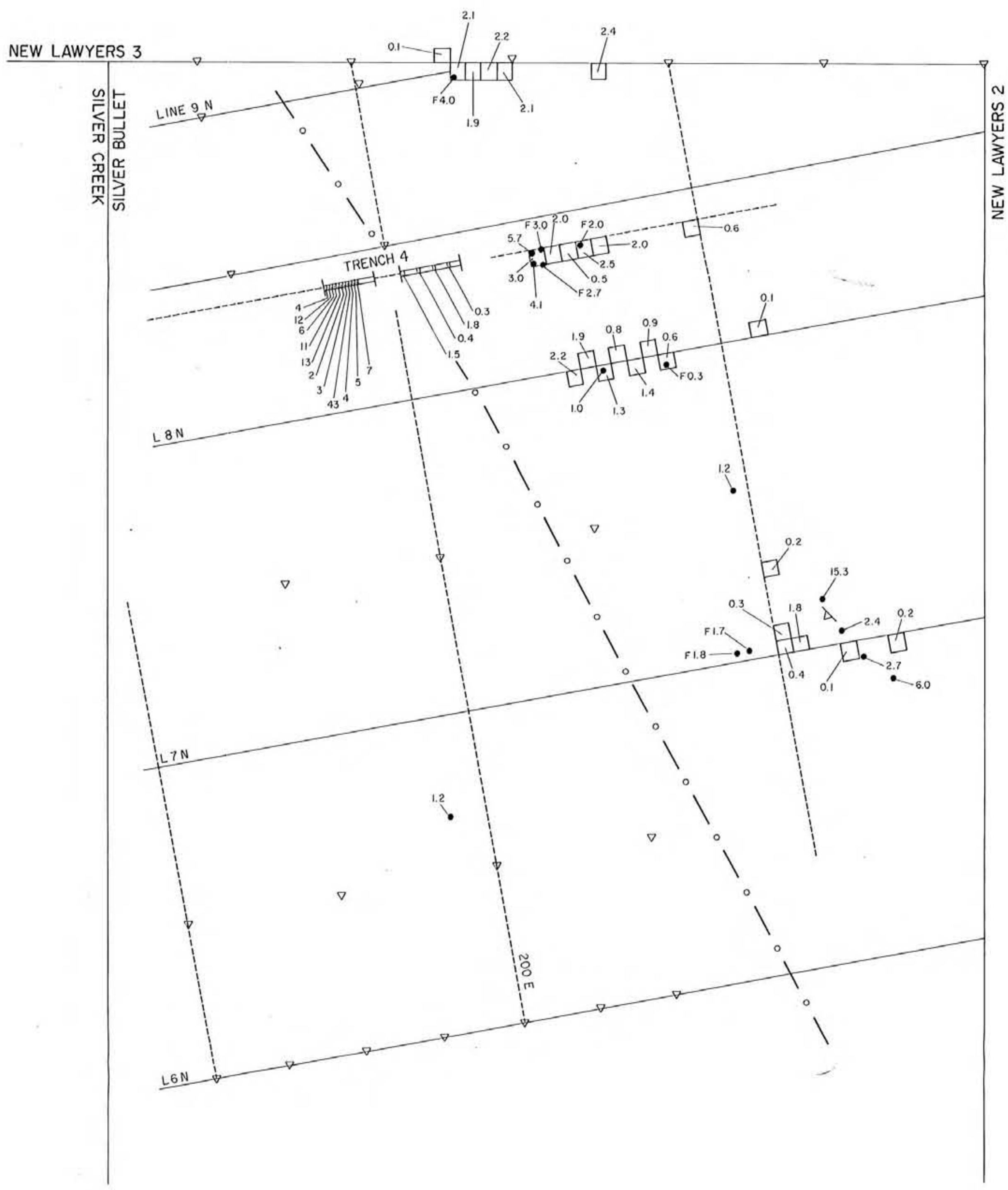

GEOLOGICAL BRANCH  
ASSESSMENT REPORT

12,911

PART 2 OF 2

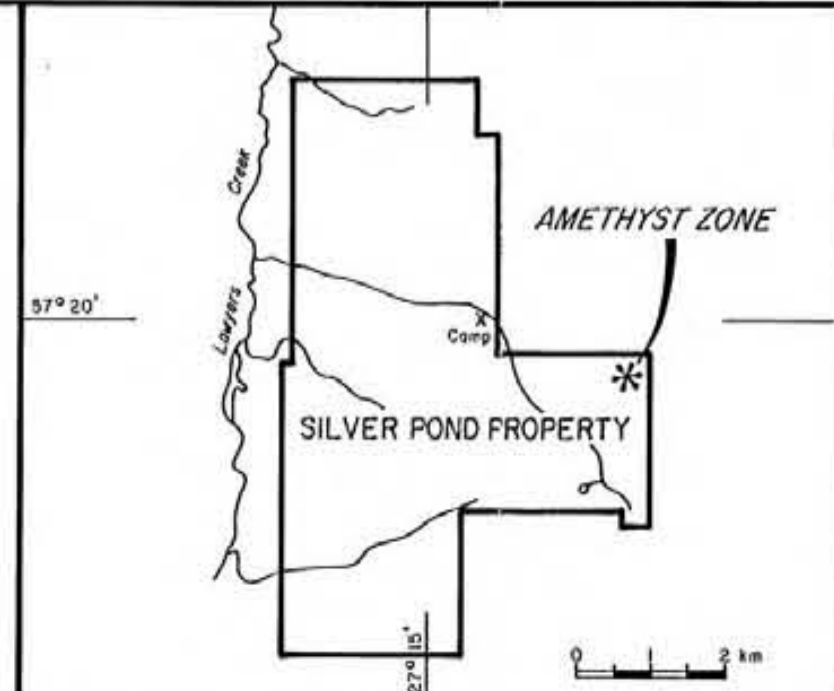
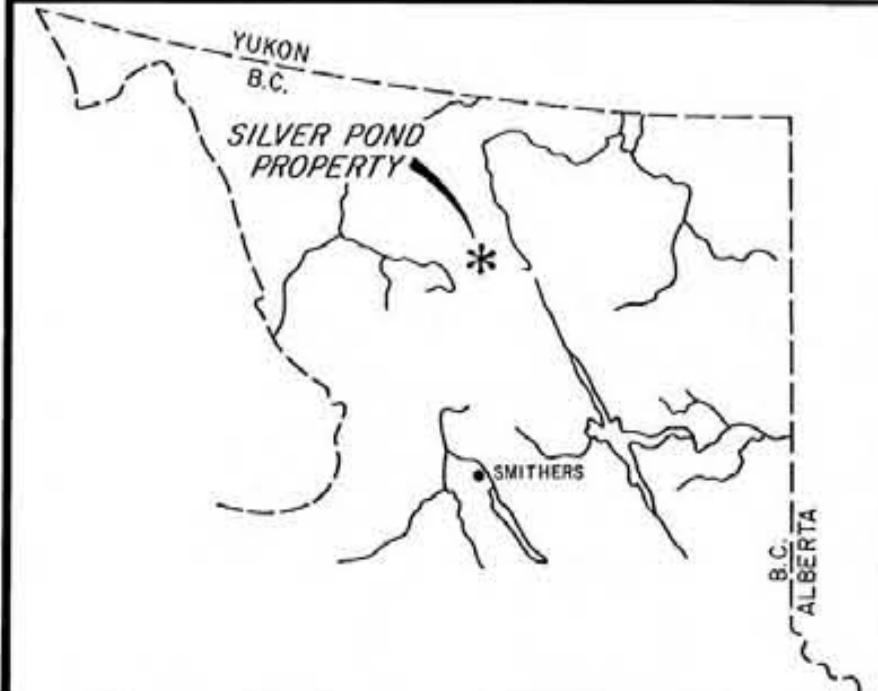

**LEGEND**

- Totus Panel Sample (5 x 5 m)
- Grab Sample
- ▽ Soil Sample, Au (ppb)
- Trend of Magnetic Low
- F Float
- Amethyst
- c Chalcedony

ST. JOE CANADA INC.			
SILVER POND PROPERTY			
AMETHYST ZONE			
SILVER (ppm)			
SCALE 1:1000			
Metres 0 10 20 40 60 80 100			
PLAN No:	DRAWN BY: A.V.	DATE: NOVEMBER 1984	FIGURE No:
		NTS 94 E / 6 E	31



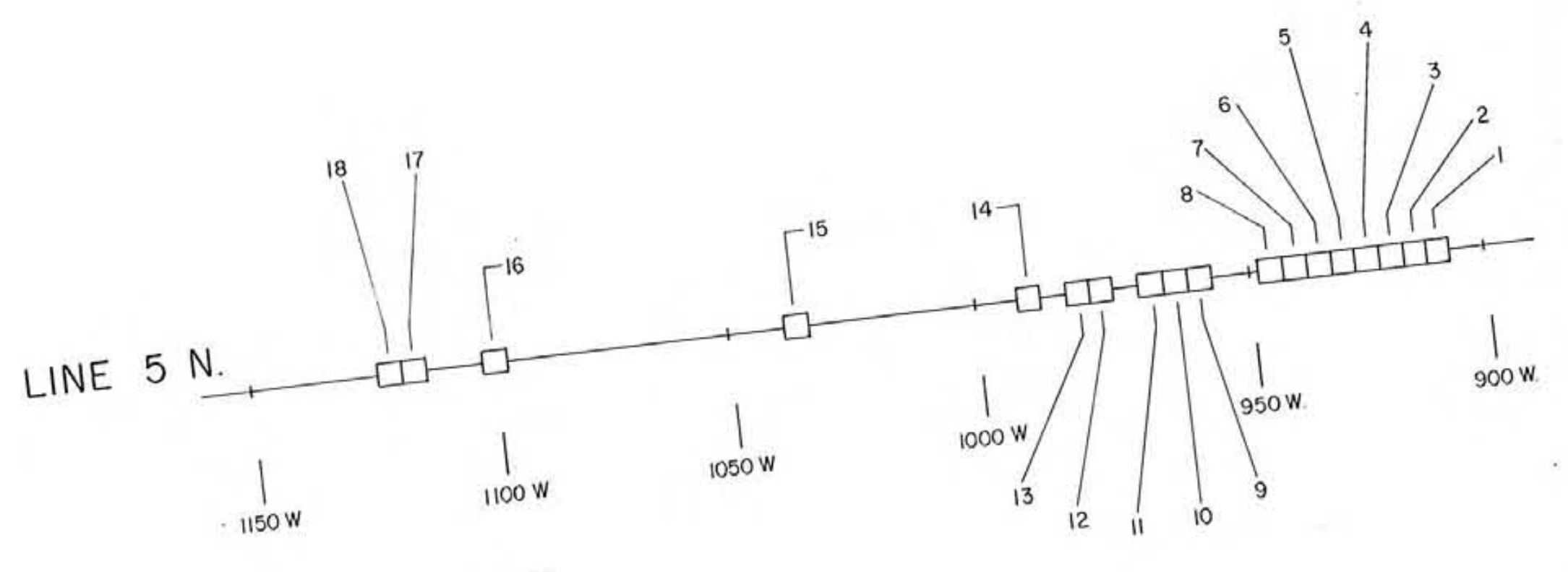
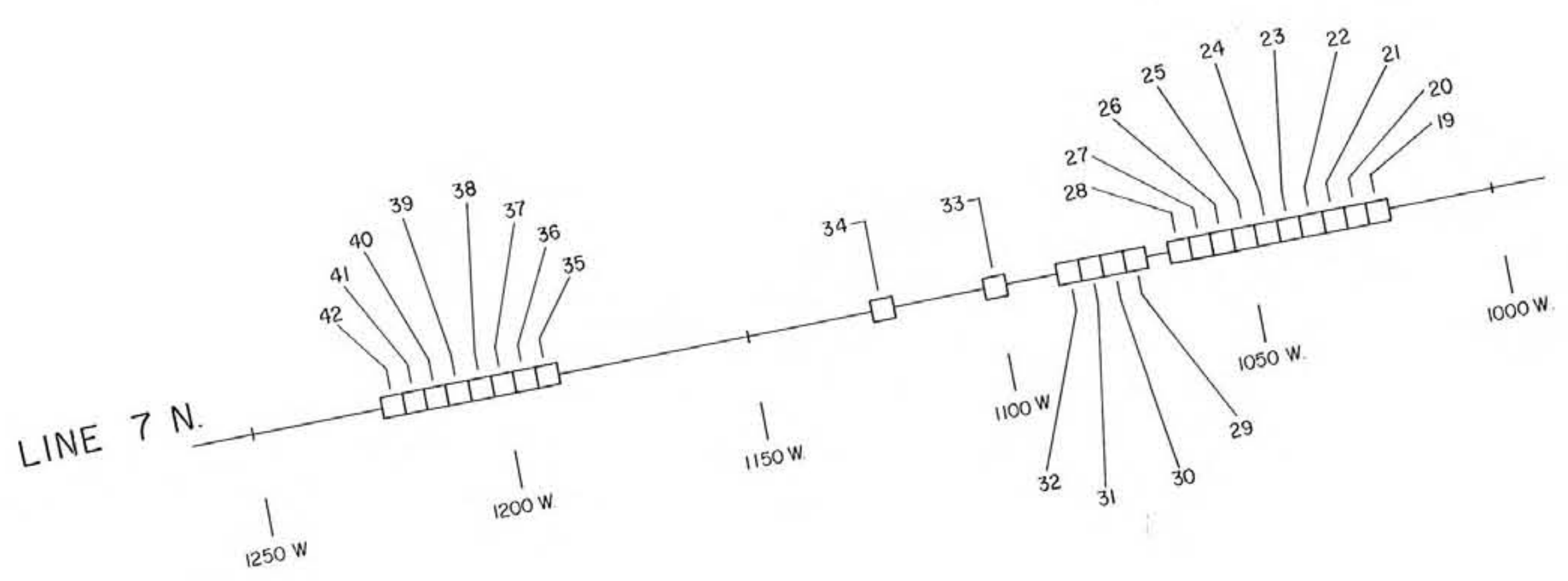
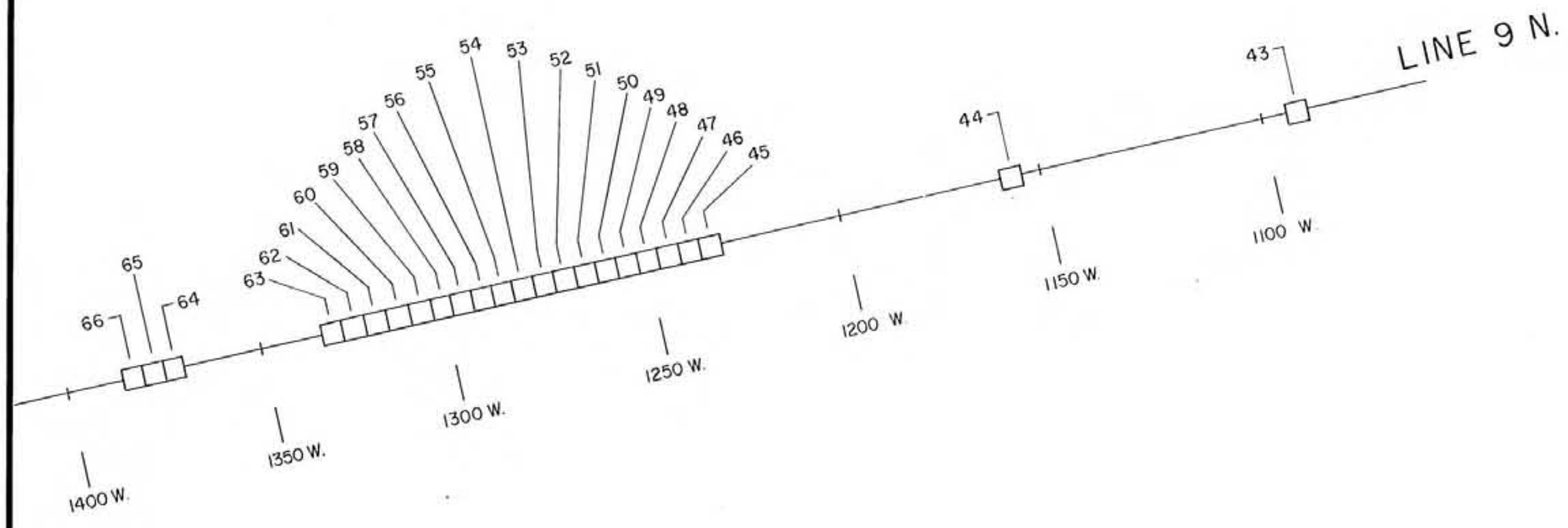

GEOLOGICAL BRANCH  
ASSESSMENT REPORT

12,911  
PART 2 OF 2

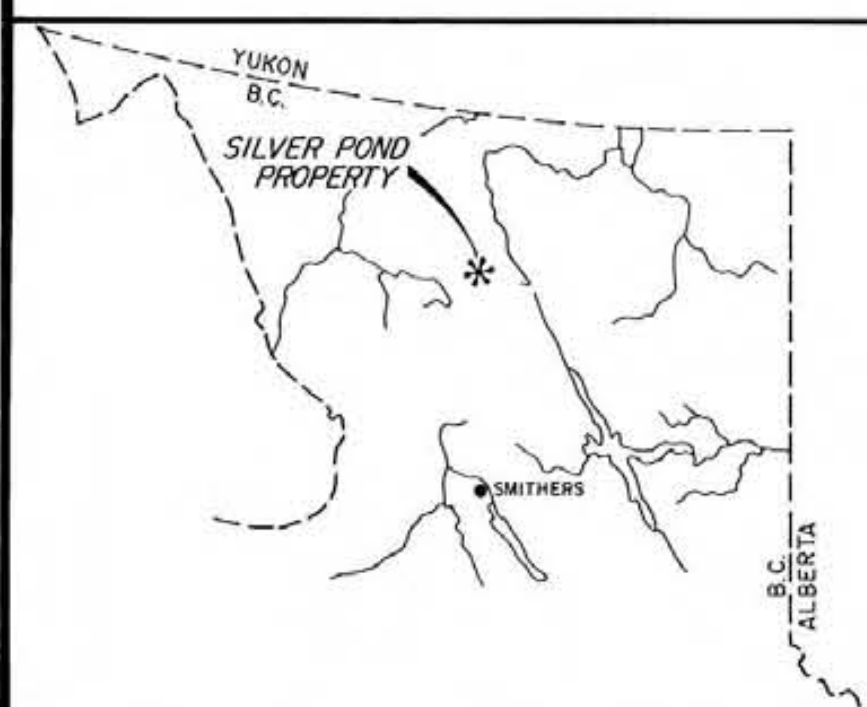

ST. JOE CANADA INC.

SILVER POND PROPERTY  
WEST ZONE - SOUTH GRID  
TALUS PANEL SAMPLES  
SAMPLE LOCATIONS

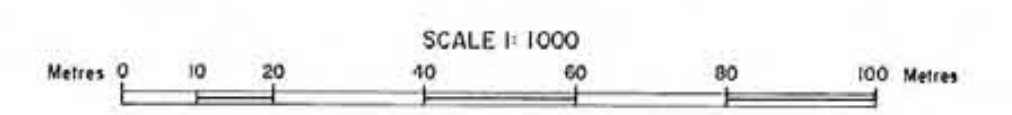

PLAN No:	DRAWN BY: A.W.	DATE: NOVEMBER, 1984	FIGURE No: 32
		NTS 94E/6E	

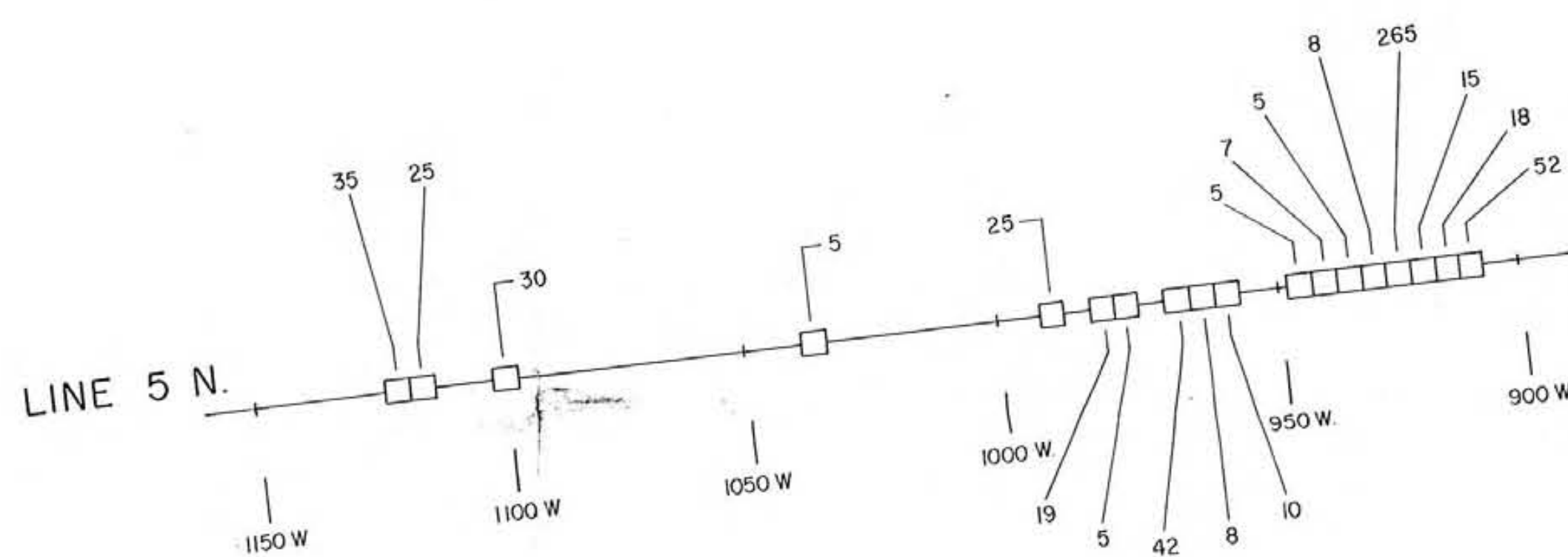
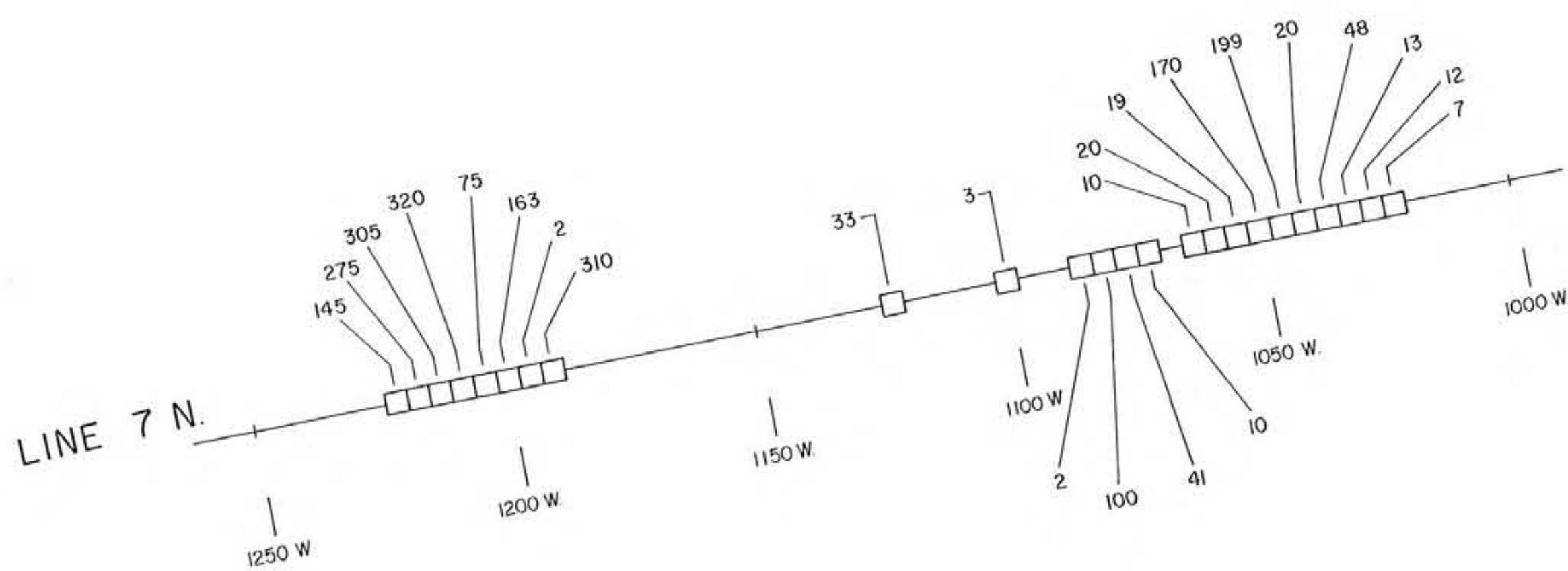
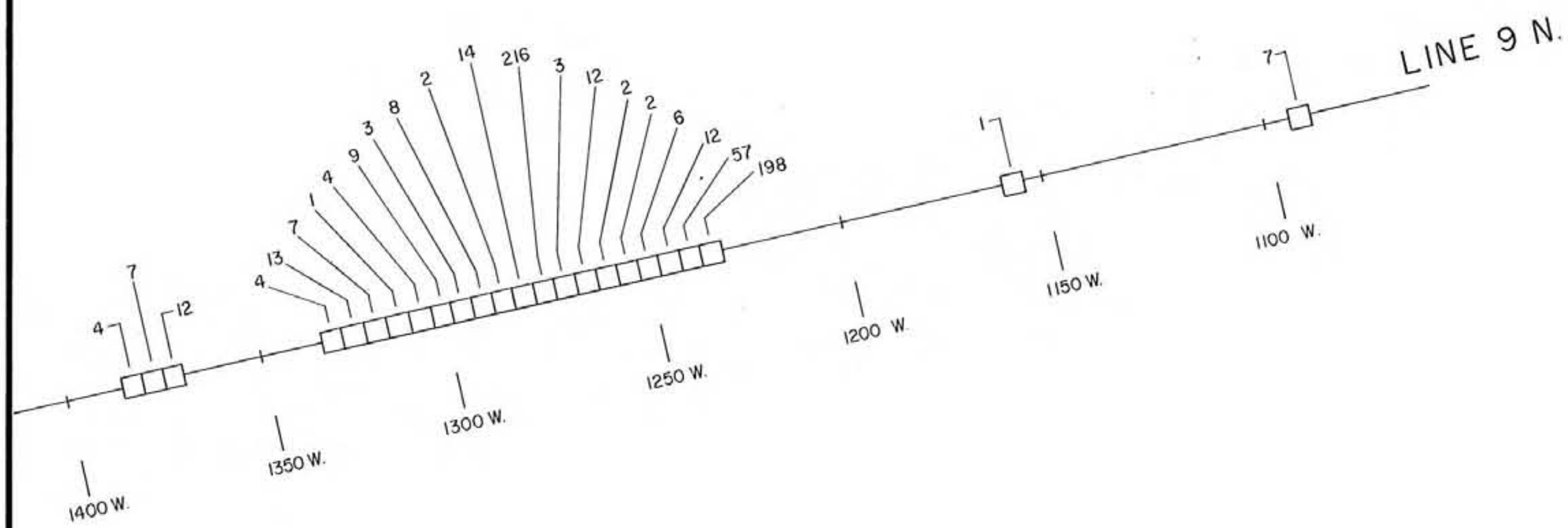

GEOLOGICAL BRANCH  
ASSESSMENT REPORT

12,911

PART 2 OF 2

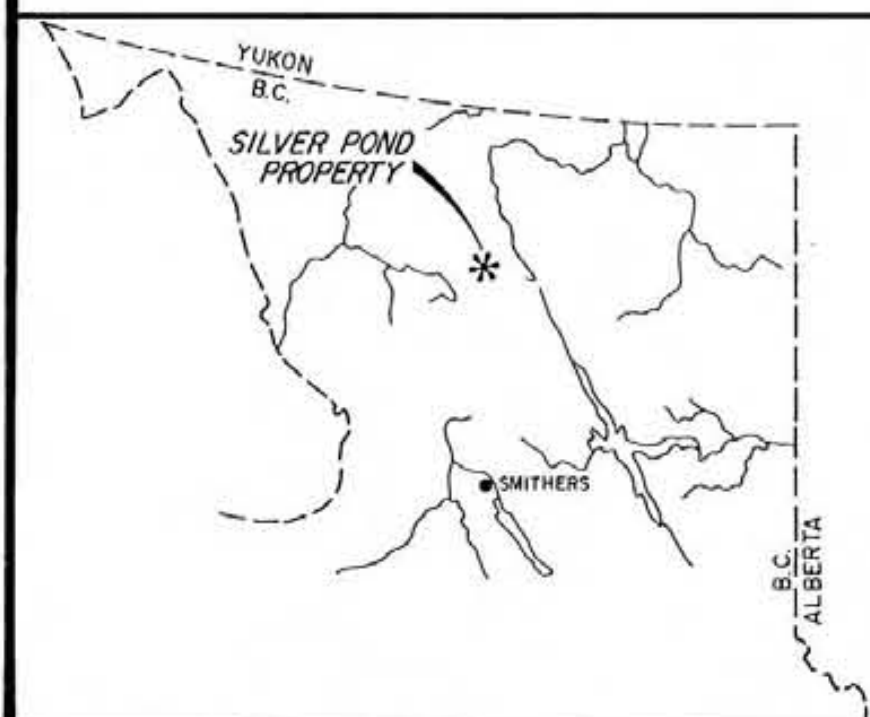

ST. JOE CANADA INC.  
SILVER POND PROPERTY  
WEST ZONE - SOUTH GRID  
TALUS PANEL SAMPLES  
Au in ppb



PLAN No:	DRAWN BY: A.W.	DATE: NOVEMBER, 1984	FIGURE No: 33
		NTS 94E/6E	



SEREM INC.  
ST. JOE CANADA INC.

L 10 N

L 9.5 N

L 9 N

L 8.5 N

L 8 N

L 7.5 N

L 7 N

L 6.5 N

L 6 N

L 5.5 N

L 5 N

TRENCH 3

TRENCH 1

TRENCH 5

TRENCH 2

BASE LINE



GEOLOGICAL BRANCH  
ASSESSMENT REPORT

12,911

PART 2 OF 2

ST. JOE CANADA INC.

SILVER POND PROPERTY  
CLIFF CREEK EXTENSION  
TRENCH SAMPLING  
SAMPLE LOCATIONS

SCALE 1:500  
Meters 0 5 10 20 30 40 50

PLAN No: \_\_\_\_\_ DRAWN BY: D.K. DATE: DECEMBER 1994 FIGURE No: \_\_\_\_\_  
NTS 94E / 6E 35

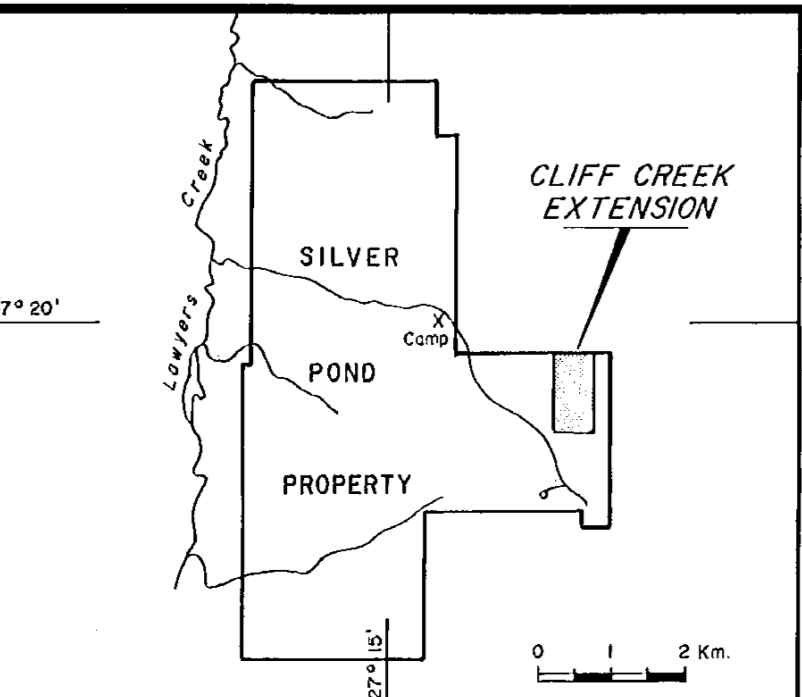
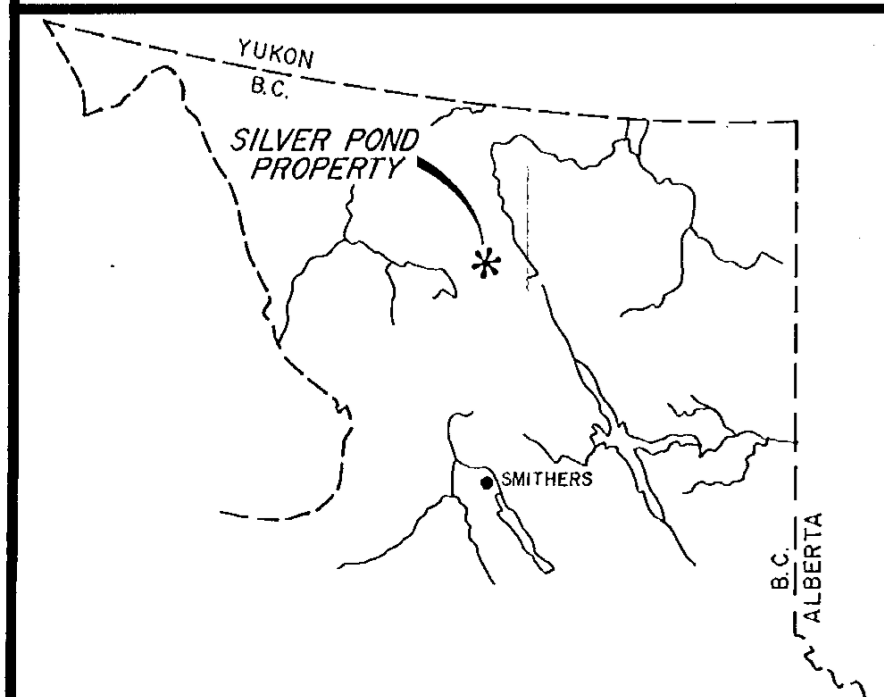

SEREM INC.  
ST. JOE CANADA INC.

L 10 N

L 9.5 N

L 9 N

L 8.5 N

L 8 N

L 7.5 N

L 7 N

L 6.5 N

L 6 N

L 5.5 N

L 5 N

TRENCH 3

TRENCH 1

TRENCH 5

TRENCH 2

BASE LINE

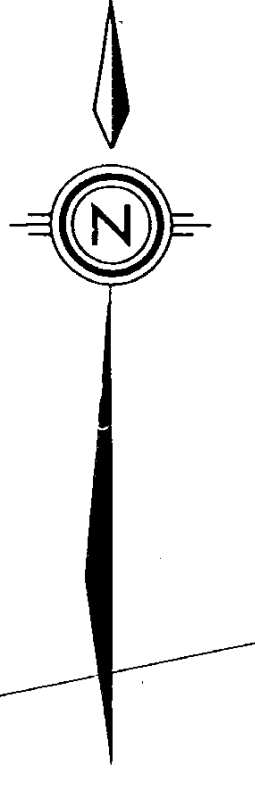

GEOLOGICAL BRANCH  
ASSESSMENT REPORT

**12,911**

PART 20P2

ST. JOE CANADA INC.

SILVER POND PROPERTY  
CLIFF CREEK EXTENSION  
TRENCH SAMPLING  
GOLD (g/tonne)

SCALE 1:500  
Metres 0 5 10 20 30 40 50

PLAN No:	DRAWN BY:	DATE:	FIGURE No:
	D. K.	DECEMBER 1994	36
		NTS 94E/6E	

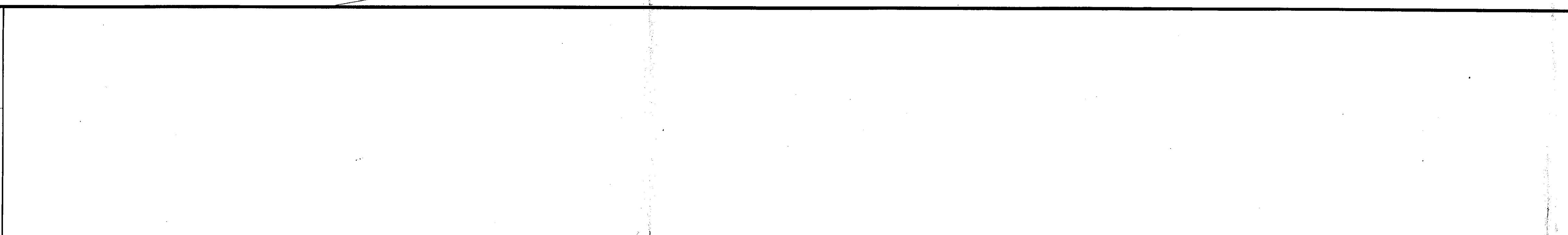
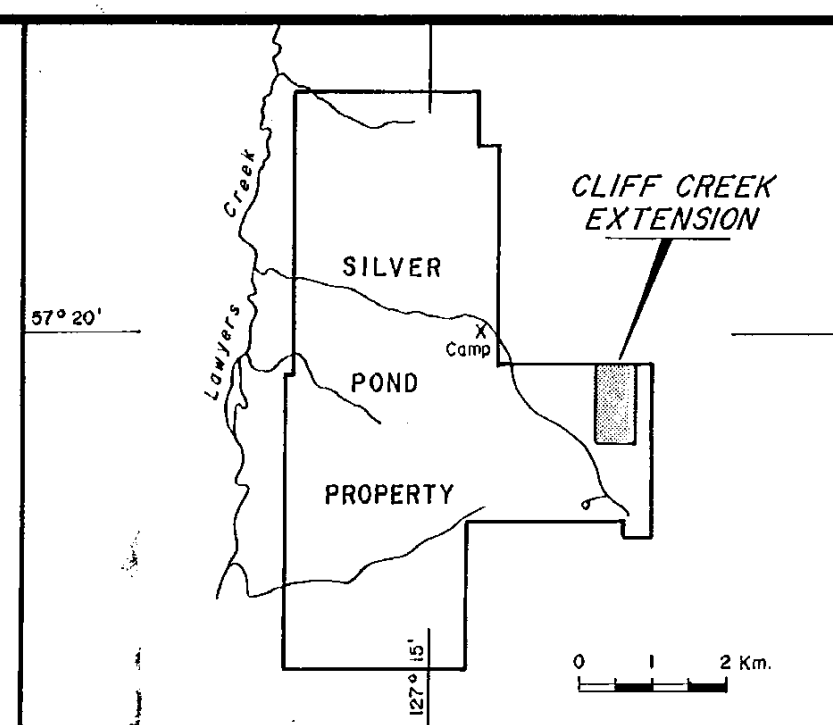
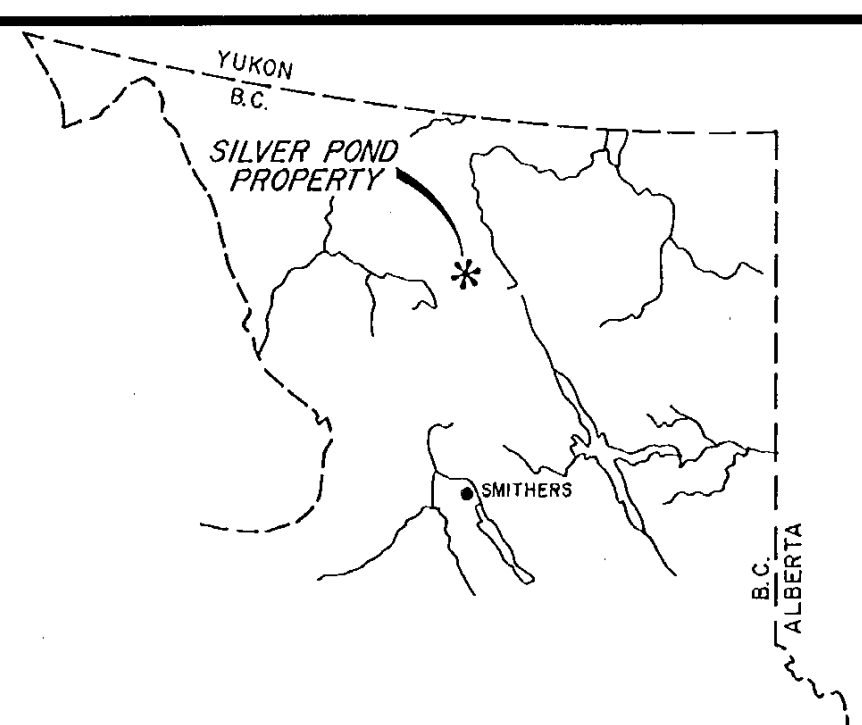



SEREM INC.  
ST. JOE CANADA INC.

L 10 N

L 9.5 N

L 9 N

L 8.5 N

L 8 N

L 7.5 N

L 7 N

L 6.5 N

L 6 N

L 5.5 N

L 5 N

TRENCH 3

TRENCH 1

TRENCH 5

TRENCH 2

BASE LINE

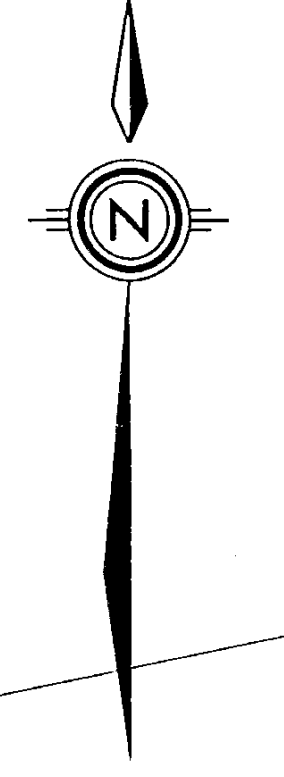

GEOLOGICAL BRANCH  
ASSESSMENT REPORT

12,911

PART 2 OF 2

ST. JOE CANADA INC.

SILVER POND PROPERTY  
CLIFF CREEK EXTENSION  
TRENCH SAMPLING  
SILVER (g/tonne)

SCALE 1:500  
Metres 0 10 20 30 40 50

PLAN No. ORGAN BY: D.K. DATE: DECEMBER 1994 FIGURE No. NTS 94E/6E 37

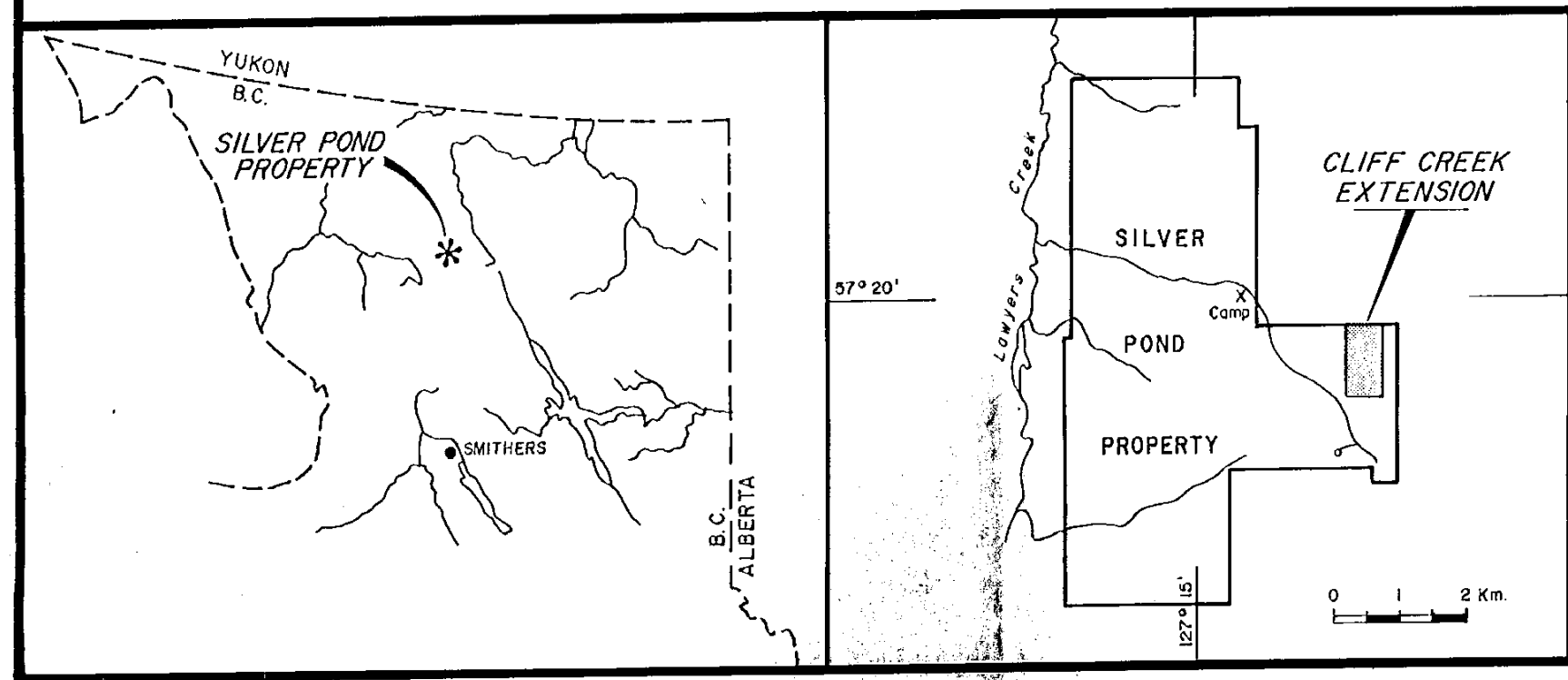

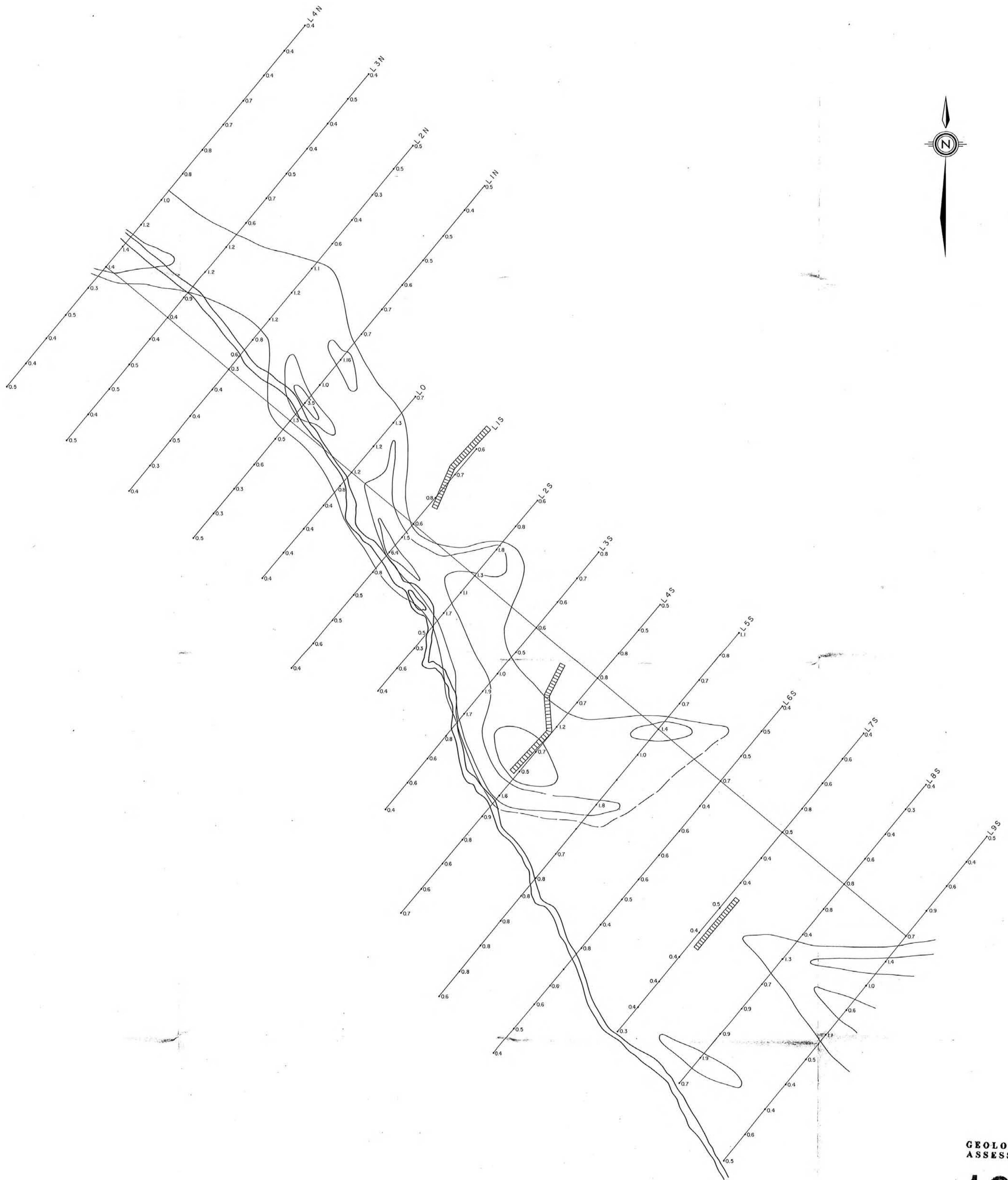

GEOLOGICAL BRANCH  
ASSESSMENT REPORT

12,911

PART 2 OF 2

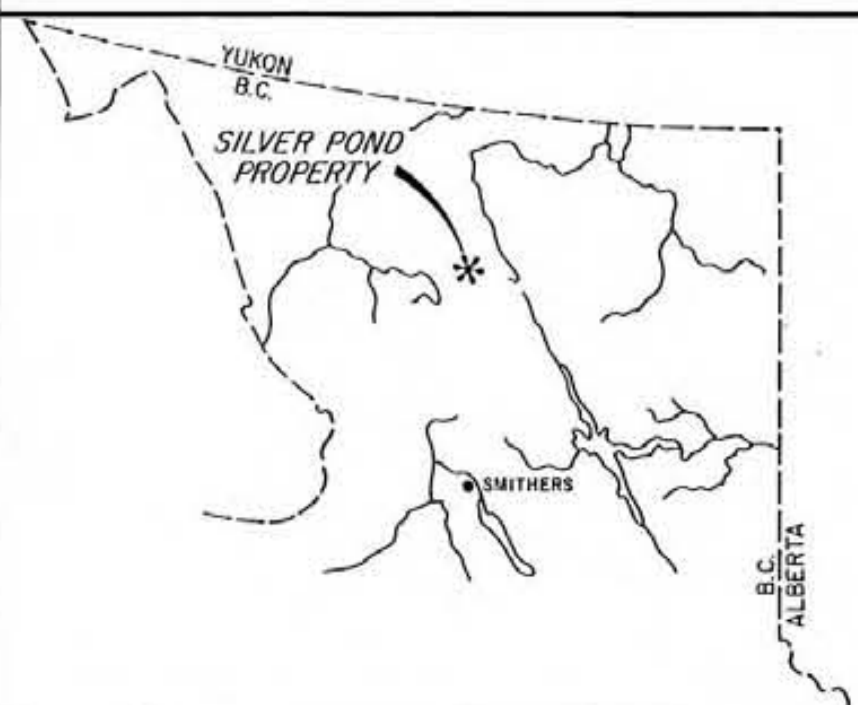

LEGEND

N = 189                       $\bar{X}$  = MEAN  
 CONTOUR LEVELS              S = STANDARD DEVIATION  
 1.00 =  $\bar{X} + S$   
 1.35 =  $\bar{X} + 2S$   
 2.1 =  $\bar{X} + 4S$

Note: Two Highest Values Were Not Used During Statistical Calculations

ST. JOE CANADA INC.

SILVER POND PROPERTY  
SILVER CREEK OCCURRENCE

SOIL GEOCHEMICAL SURVEY  
SILVER IN PPM

SCALE 1:500

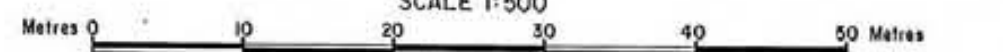

PLAN No:	DRAWN BY: MRW	DATE: NOVEMBER, 1984	FIGURE No:
		NTS	40
		94E/SE	







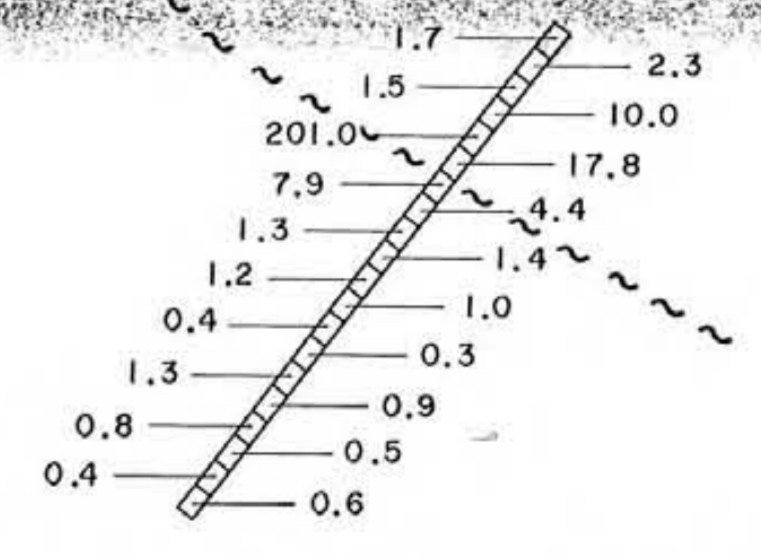
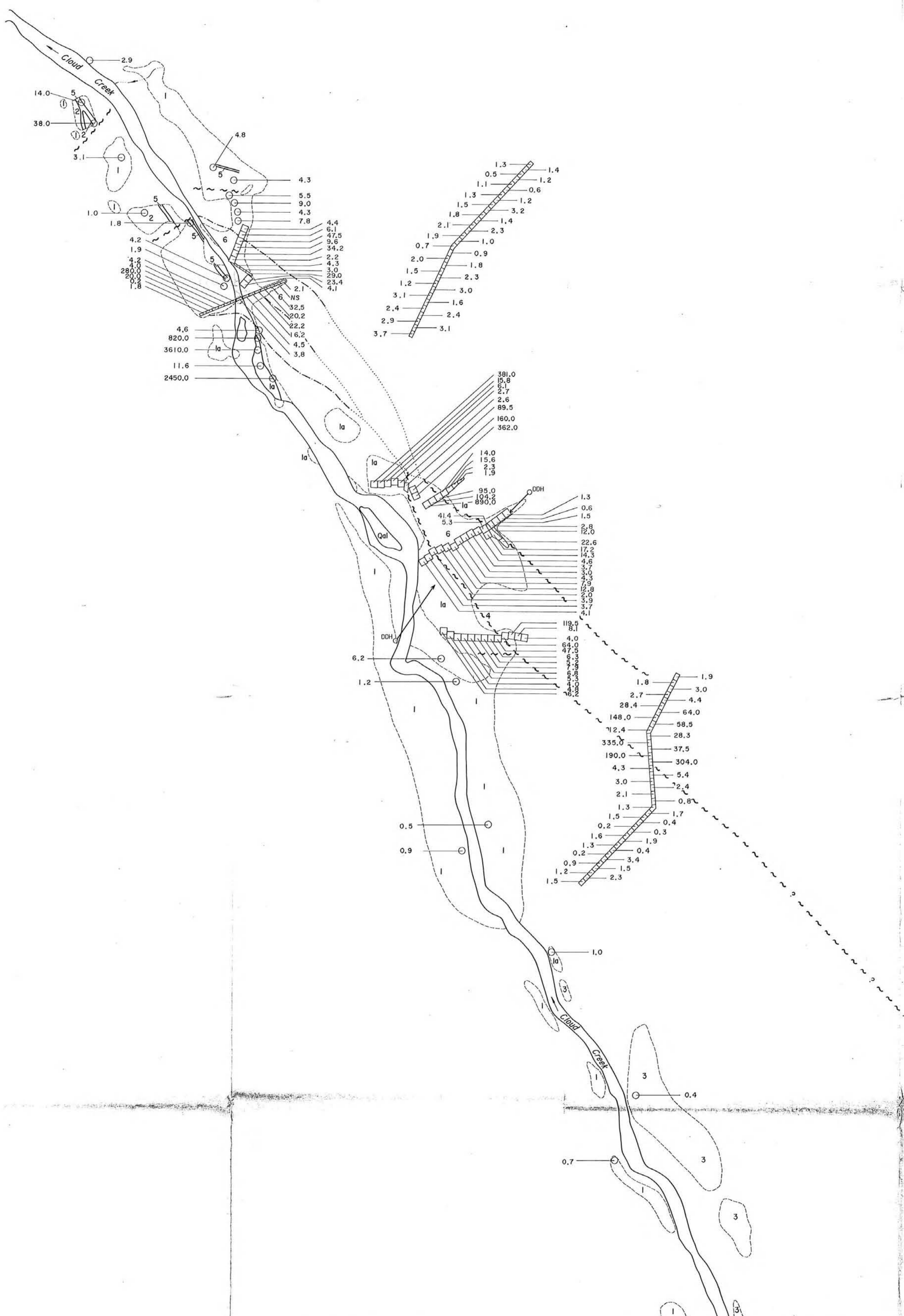

GEOLOGICAL BRANCH  
ASSESSMENT REPORT

**12,911**  
PART 2 OF 2

ST. JOE CANADA INC.

SILVER POND PROPERTY  
SILVER CREEK OCCURRENCE  
SILVER ASSAY VALUES(G/TONNE)

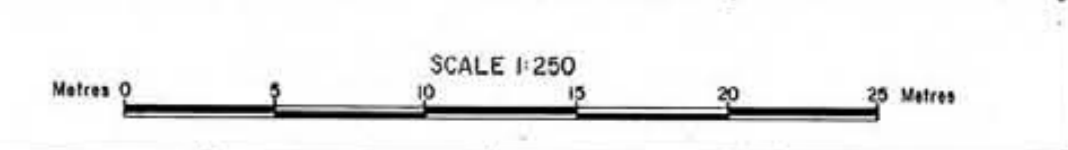

PLAN No:	DRAWN BY: MRW	DATE: NOVEMBER 1984	FIGURE No:
		NTS 94E/6E	42

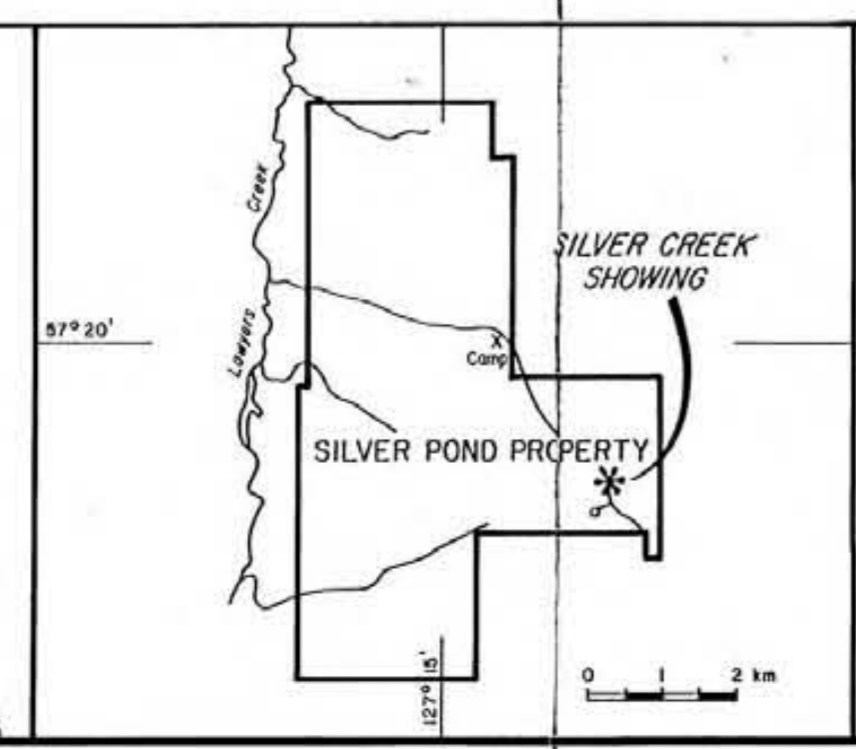
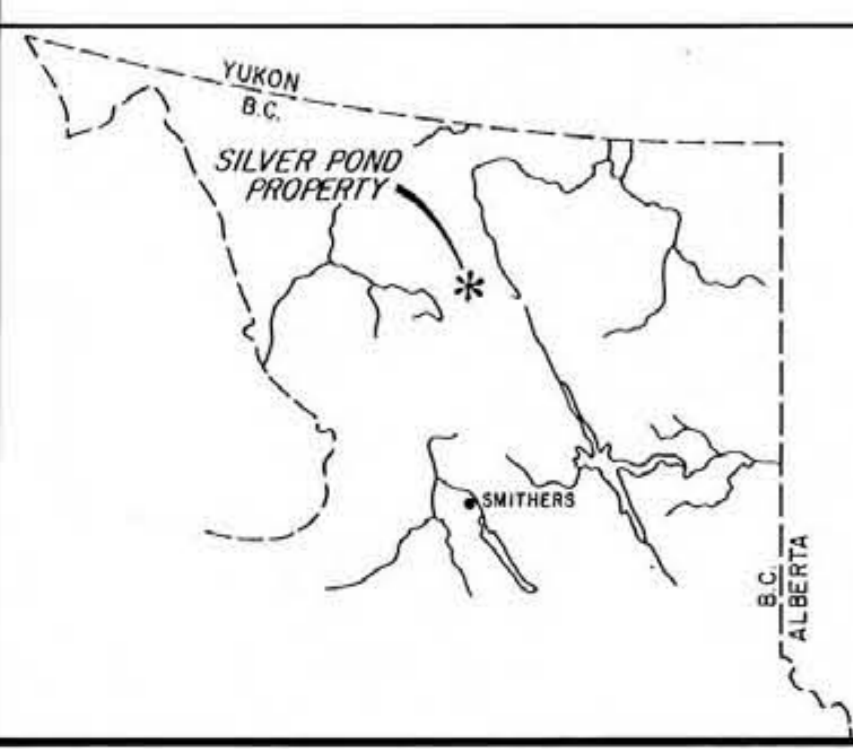

- 6 Pervasive Silicification +/- Brecciation +/- Quartz Veinlets
- 5 Less Intense Silicification
- 4 Gange Material
- 3 Maroon Tuff
- 2 Porphyritic Alkali Trachyle
- 1a Epidote Altered Andesite
- 1 Unaltered Andesite

- Geological Contacts - Observed, Assumed and Projected
- ~ ~ ~ Faults
- Outcrop
- ▭ Trenches
- ▭ Panels (Vertical, Horizontal)
- Grab Samples



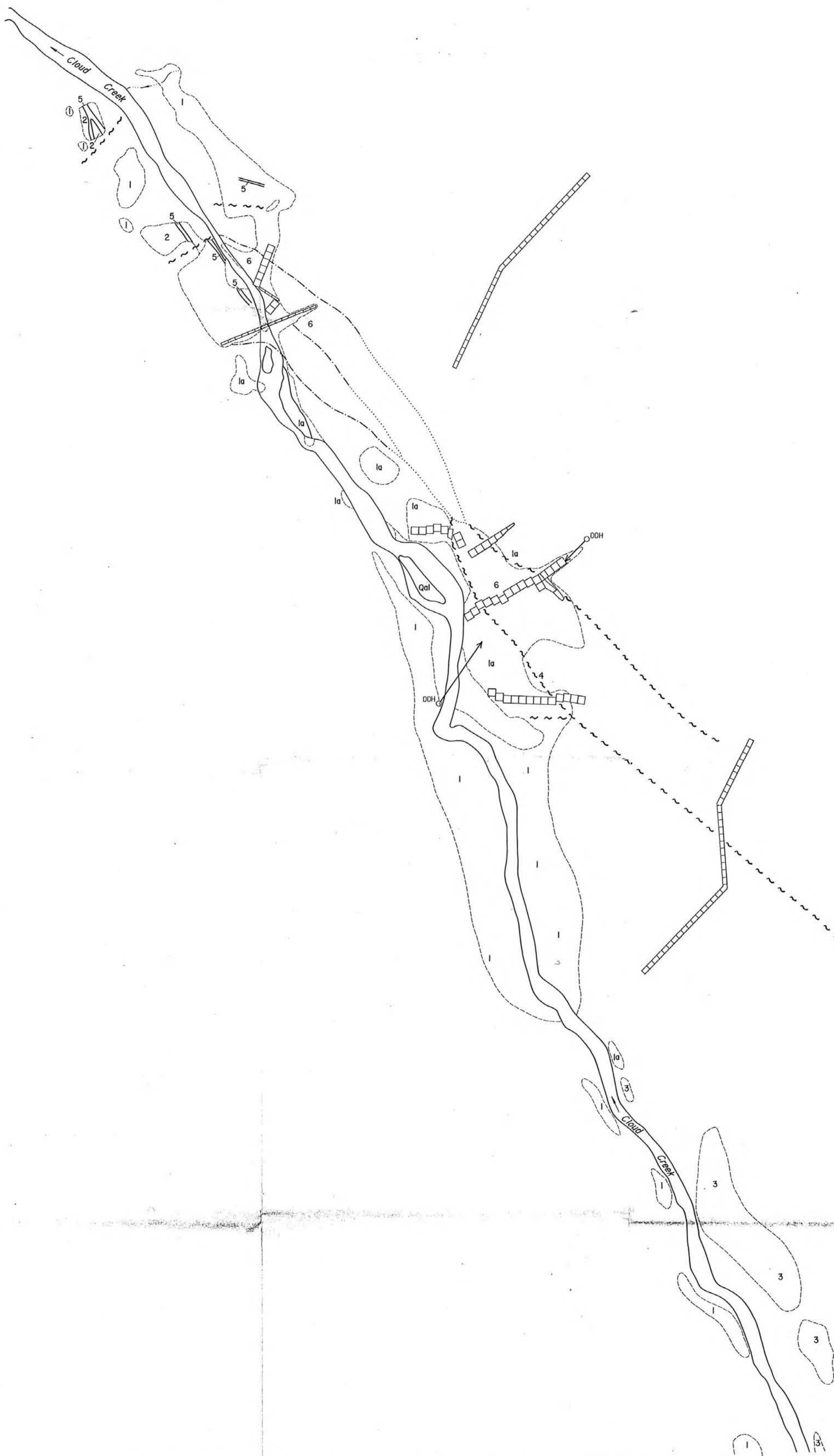

GEOLOGICAL BRANCH  
ASSESSMENT REPORT

12,911

PART 2 OF 2

ST. JOE CANADA INC.

SILVER POND PROPERTY  
SILVER CREEK SHOWING

GEOLOGY

SCALE 1:250

Metres 0 5 10 20 25

PLAN No:	DRAWN BY: MRW	DATE BY:	FIGURE No:
		NTS	43
		94E/6E	

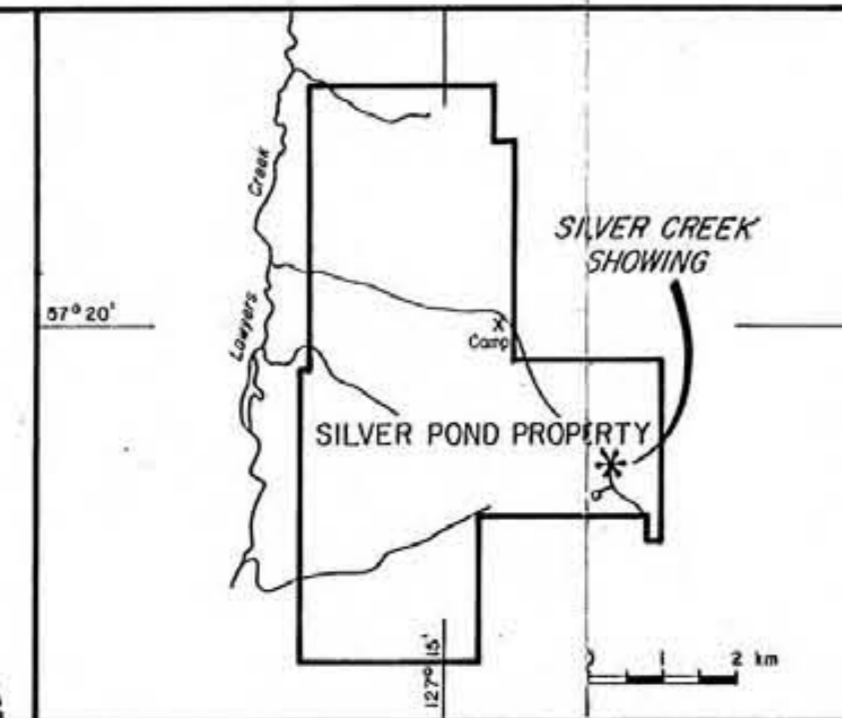
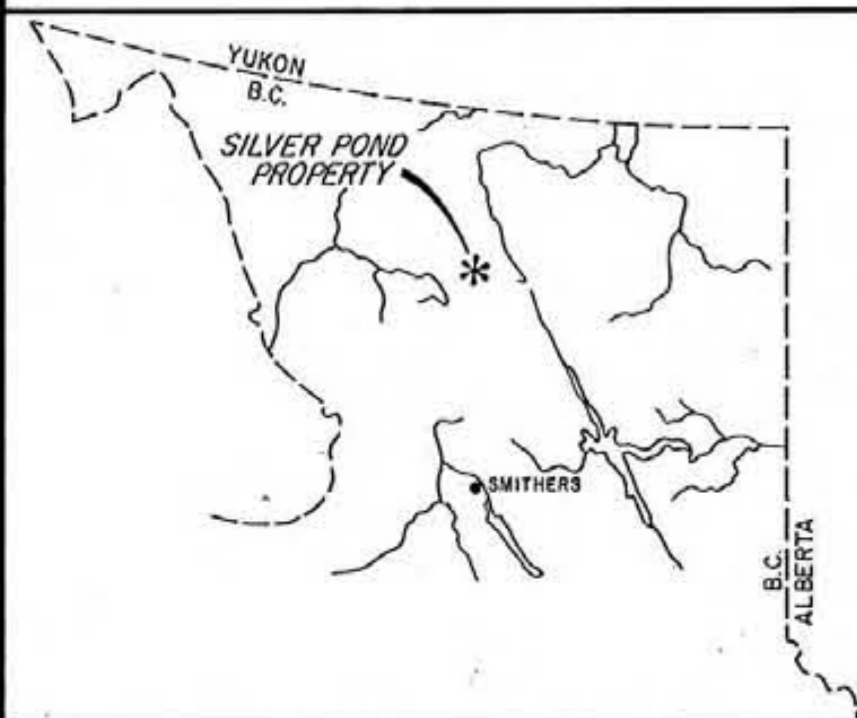

- 6 Pervasive Silicification +/- Brecciation +/- Quartz Veinlets
- 5 Less Intense Silicification
- 4 Gouge Material
- 3 Maroon Tuff
- 2 Porphyritic Alkali Trachyte
- Ia Epidote Altered Andesite
- I Unaltered Andesite

- Geological Contacts - Observed, Assumed and Projected
- ~ ~ ~ Faults
- Trenches/Panel/Grab Samples
- Outcrop



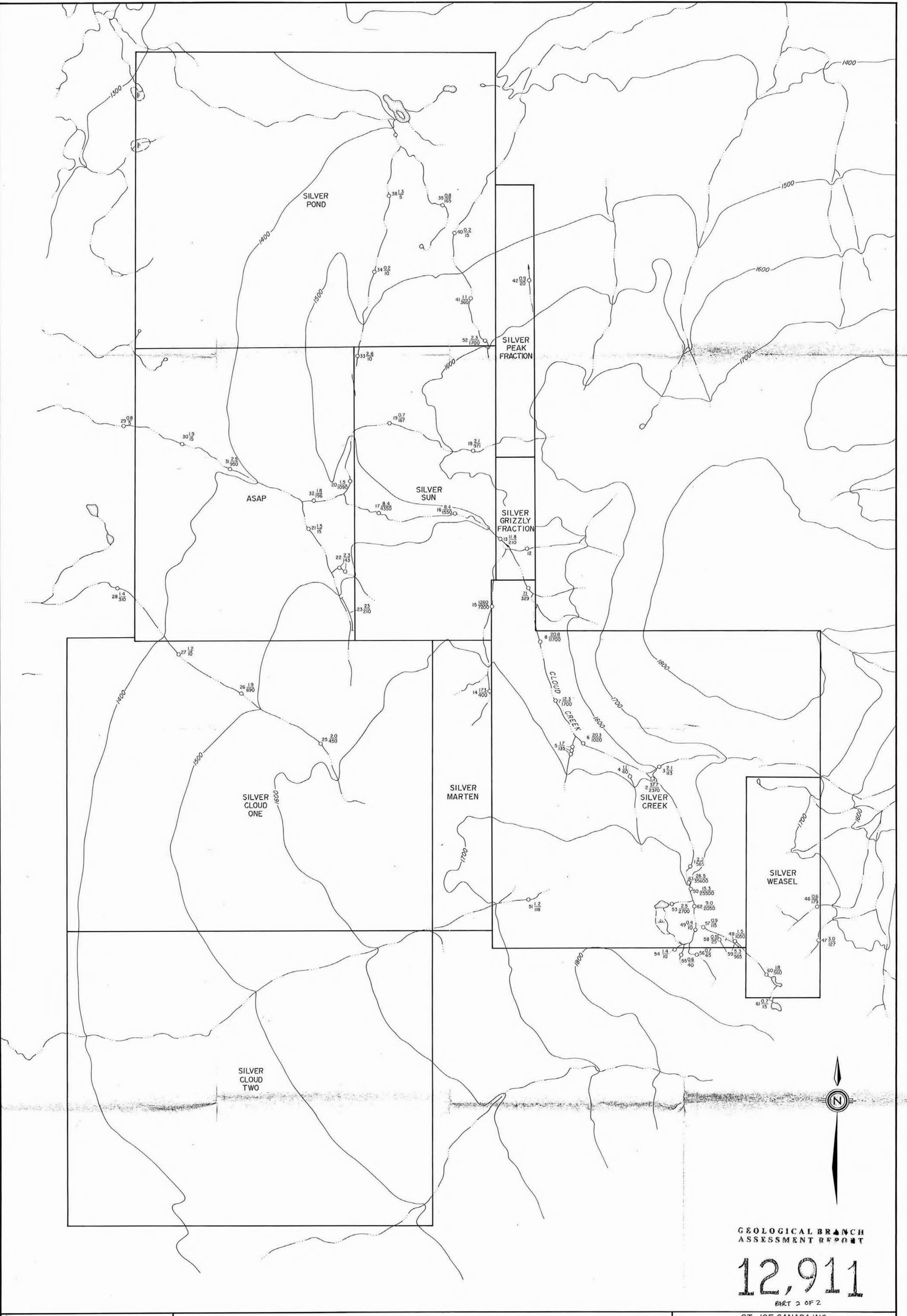

GEOLOGICAL BRANCH  
ASSESSMENT REPORT

**12,911**  
PART 2 OF 2

ST. JOE CANADA INC.

**SILVER POND PROPERTY**  
**HEAVY MINERAL STREAM**  
**SEDIMENT SAMPLES**  
**SAMPLE LOCATION AND GOLD**  
**AND SILVER VALUES**

SCALE 1:10000  
Metres 0 100 200 400 600 800 1000 Metres

PLAN No: 1	DRAWN BY: D.K.	DATE: NOVEMBER 1984	FIGURE No: 4.4
		NTS	

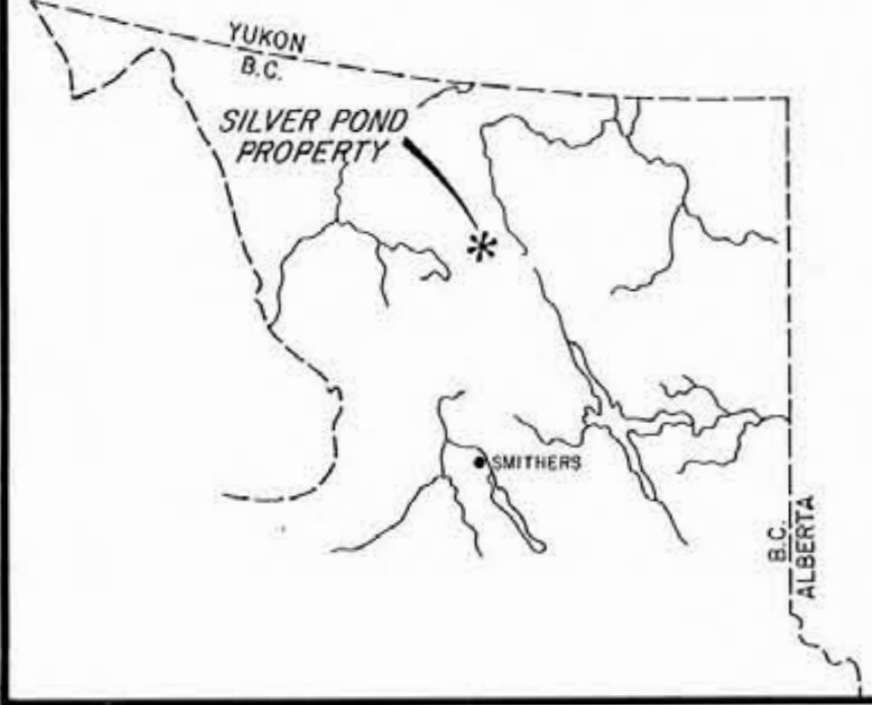

**LEGEND**

Sample Number — 21  $\frac{7.0}{167}$  Ag ppm  
Au ppb







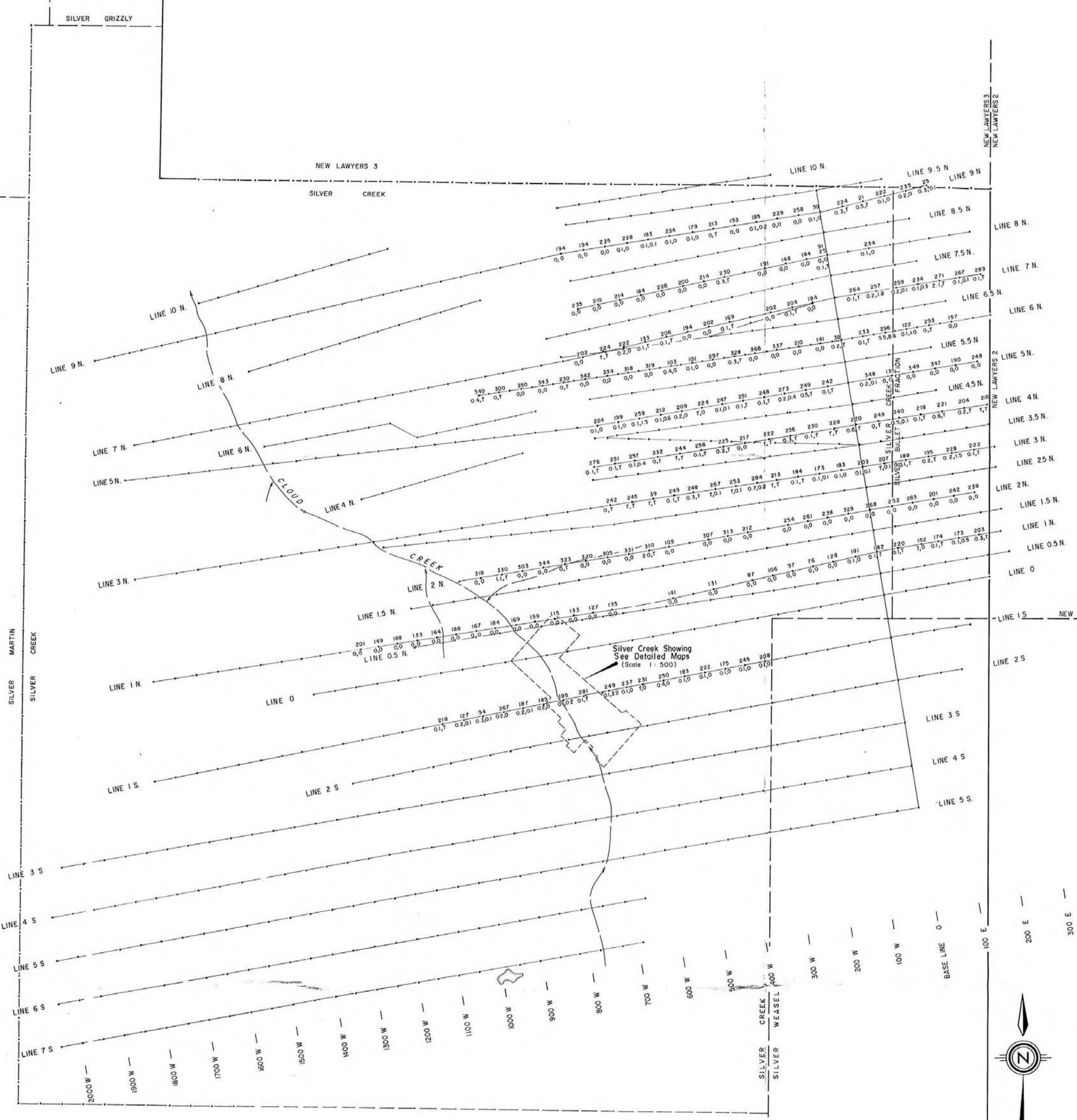

GEOLOGICAL BRANCH  
ASSESSMENT REPORT  
**12,911**  
PART 2 OF 2

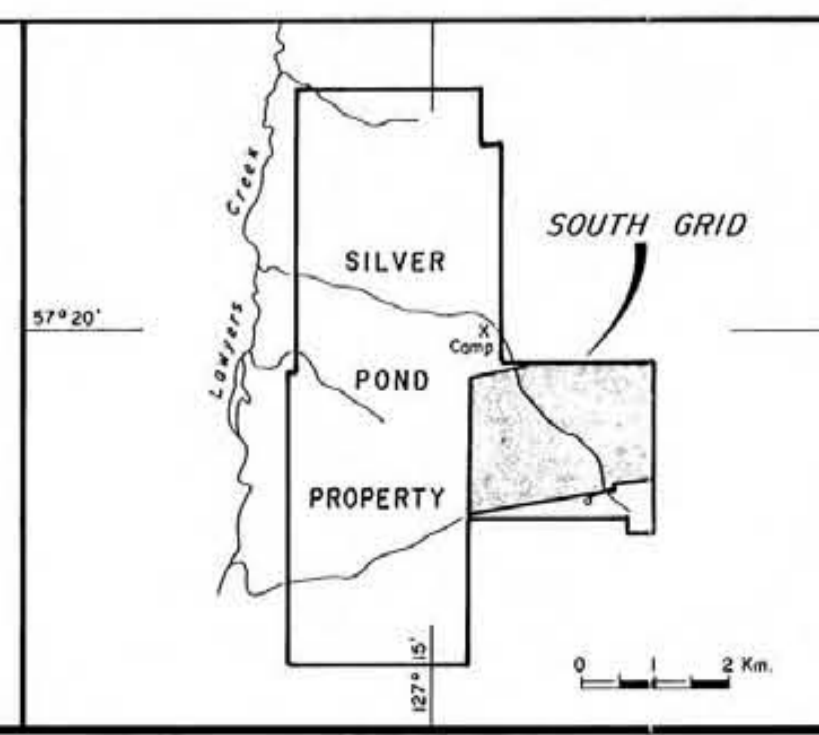
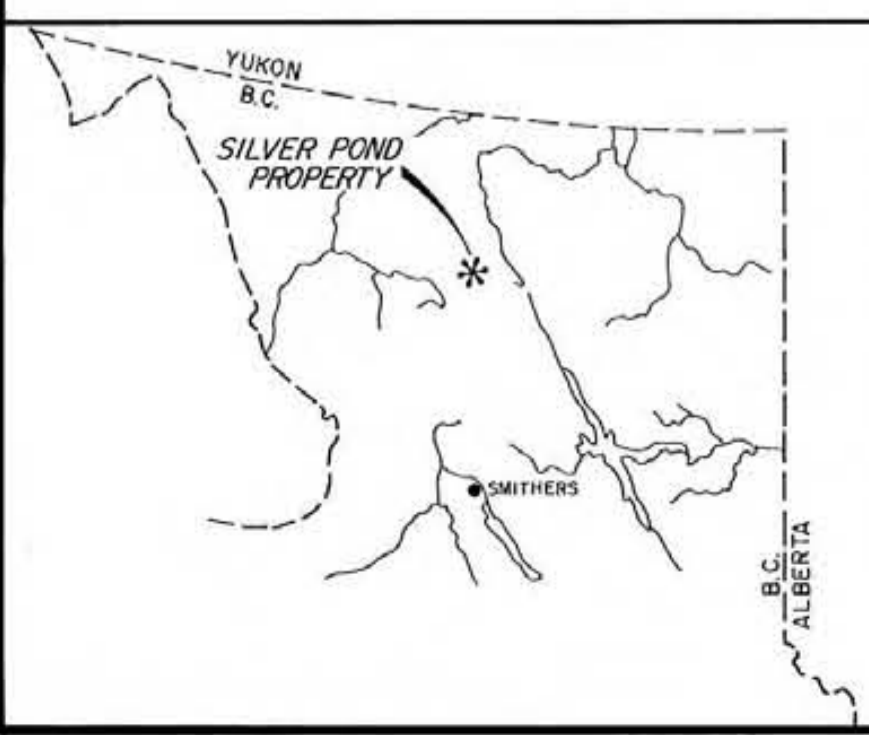

**LEGEND**  
 $CO_2$   
 $COS, CS_2$   
 T = Trace

ST. JOE CANADA INC.  
**SILVER POND PROPERTY**  
 SOUTH GRID  
**SOIL GAS GEOCHEMISTRY**

SCALE 1:5000  
 Metres 0 50 100 200 300 400 500

PLAN No:	DRAWN BY:	DATE BY:	FIGURE No:
		NTS 94E/6E	46



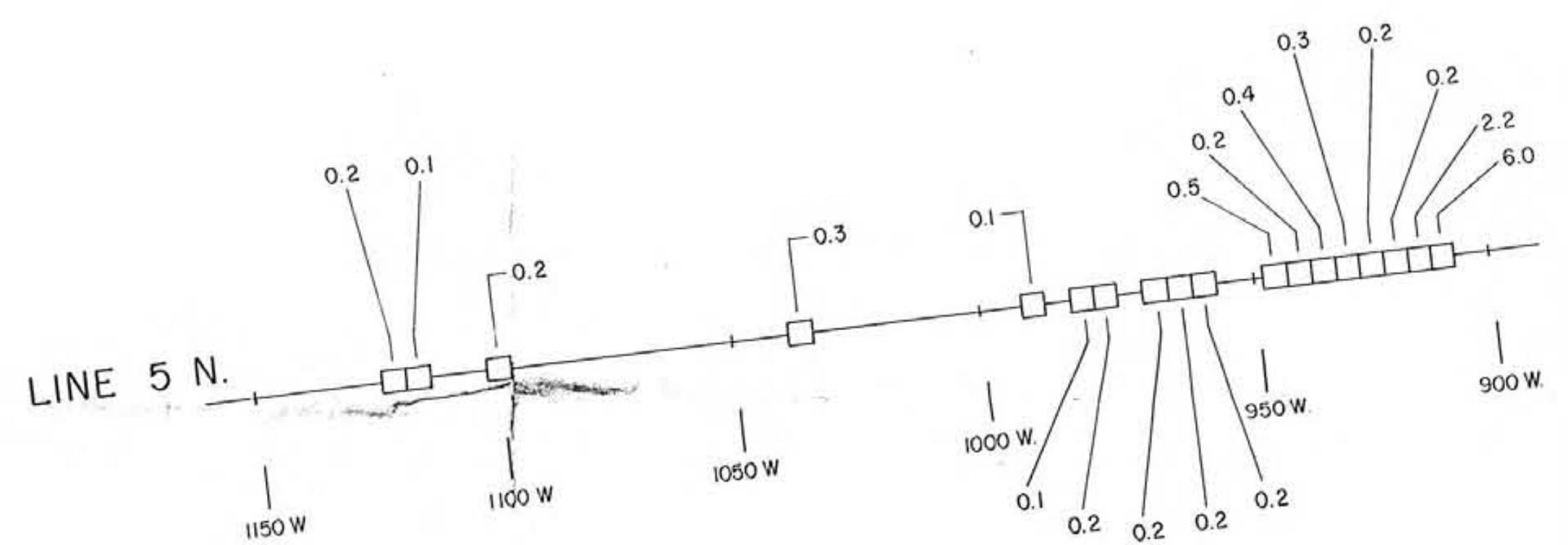
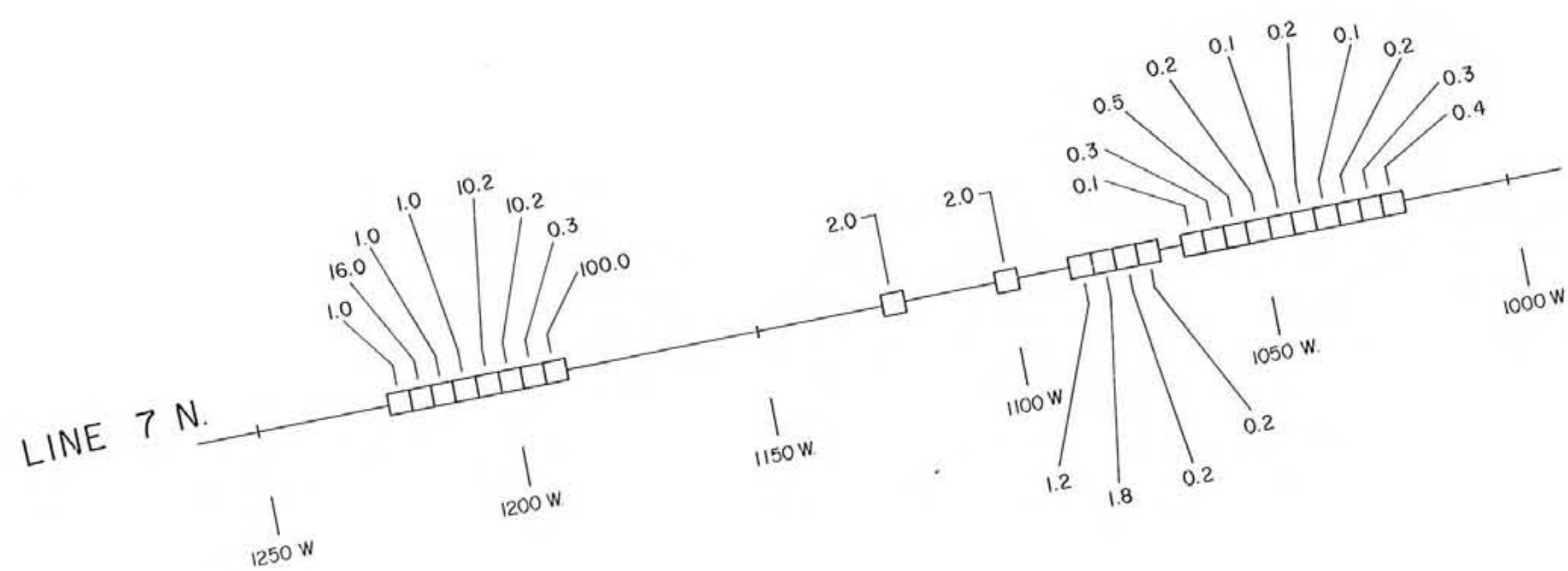
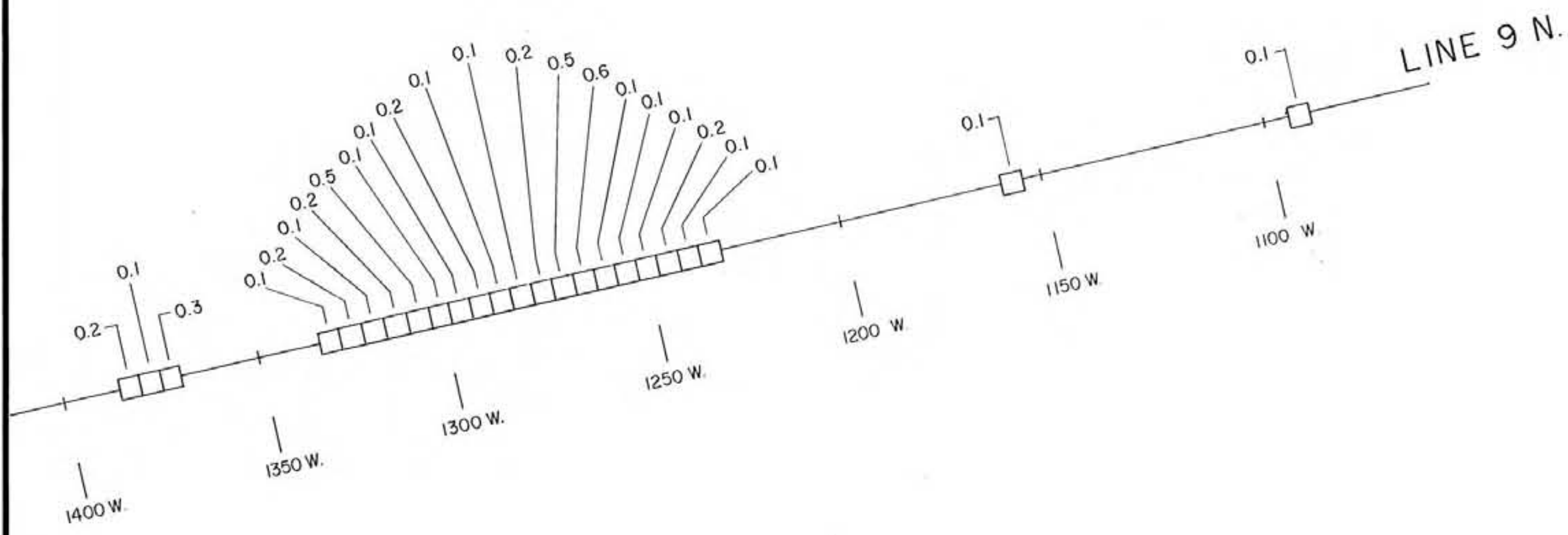

GEOLOGICAL BRANCH  
ASSESSMENT REPORT

**12,911**  
PART 2 OF 2

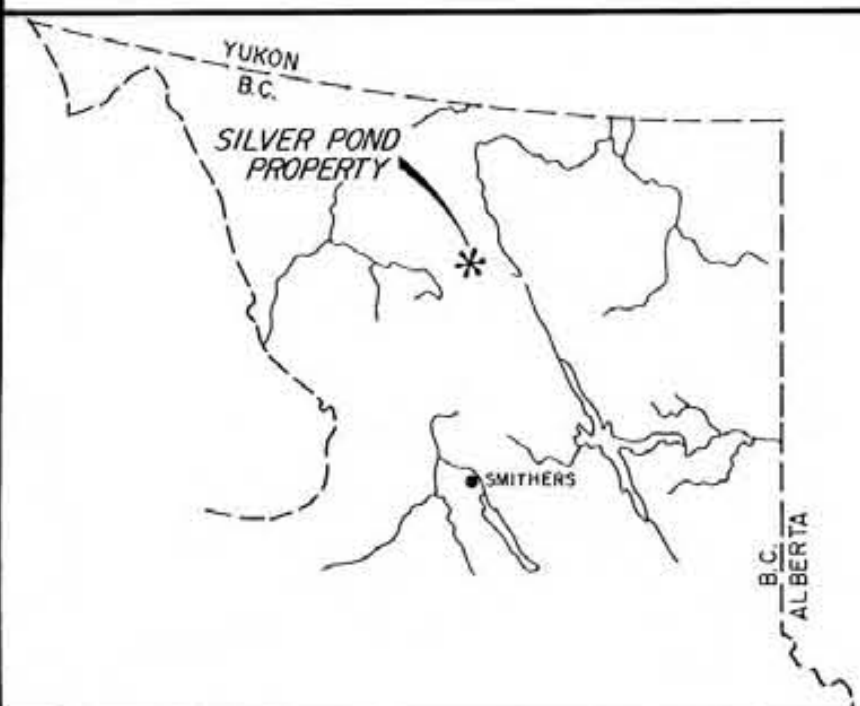

ST. JOE CANADA INC.			
SILVER POND PROPERTY			
WEST ZONE - SOUTH GRID			
TALUS PANEL SAMPLES			
Ag in ppm			
SCALE 1:1000			
Metres 0 10 20 40 60 80 100			
PLAN No:	DRAWN BY: A.W.	DATE: NOVEMBER, 1984	FIGURE No: 34
		NTS 94E/6E	



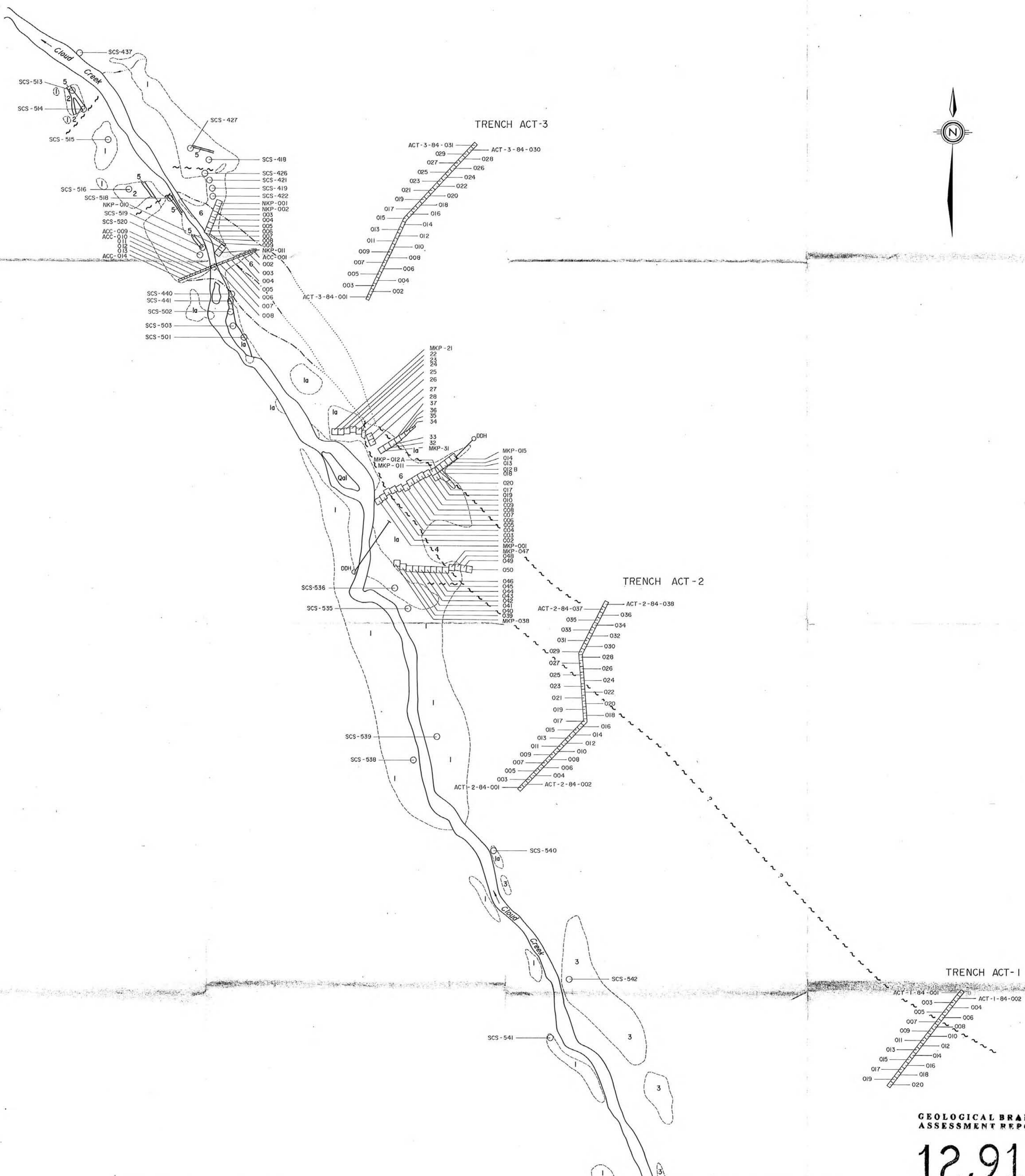

GEOLOGICAL BRANCH  
ASSESSMENT REPORT

12,911

PART 2 OF 2

ST. JOE CANADA INC.

SILVER POND PROPERTY  
SILVER CREEK SHOWING

SAMPLE LOCATIONS

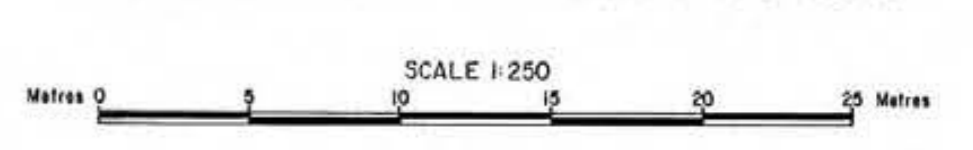

PLAN No:	DRAWN BY: MRW	DATE BY:	FIGURE No:
		NTS	38

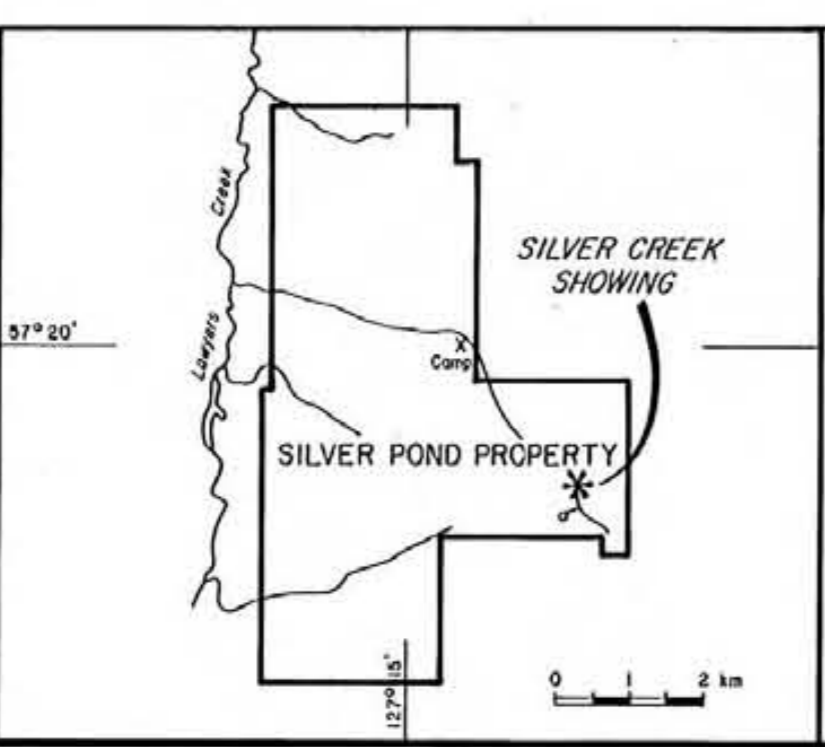
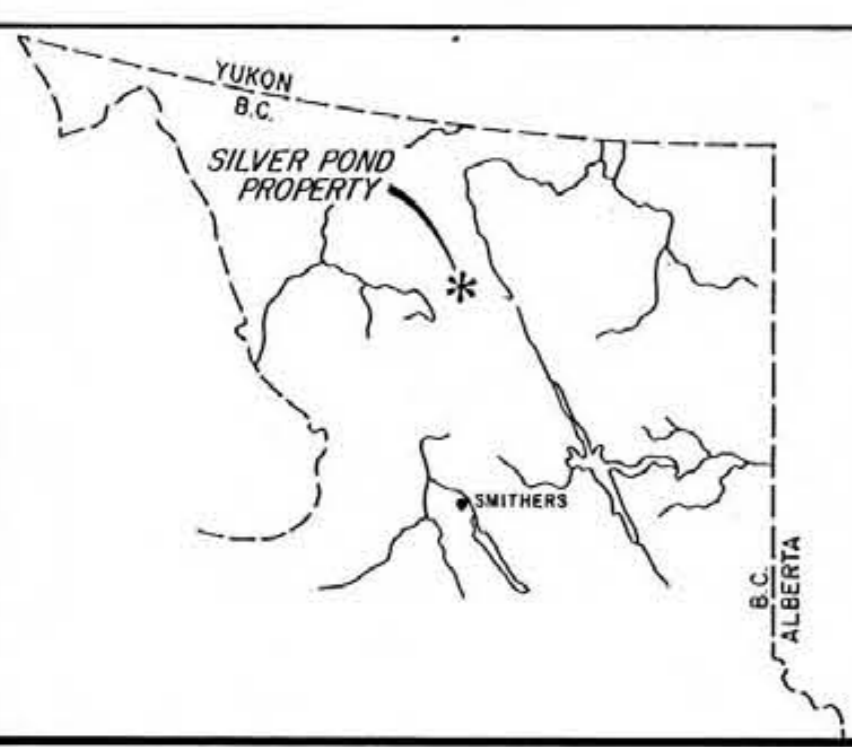

- 6 Pervasive Silicification +/- Brecciation +/- Quartz Veinlets
  - 5 Less Intense Silicification
  - 4 Gouge Material
  - 3 Maroon Tuff
  - 2 Porphyritic Alkali Trachyle
  - Ia Epidote Altered Andesite
  - I Unaltered Andesite
- Geological Contacts - Observed, Assumed and Projected
  - ~ ~ ~ Faults
  - Trenches/Panels/Grab Samples
  - Outcrop



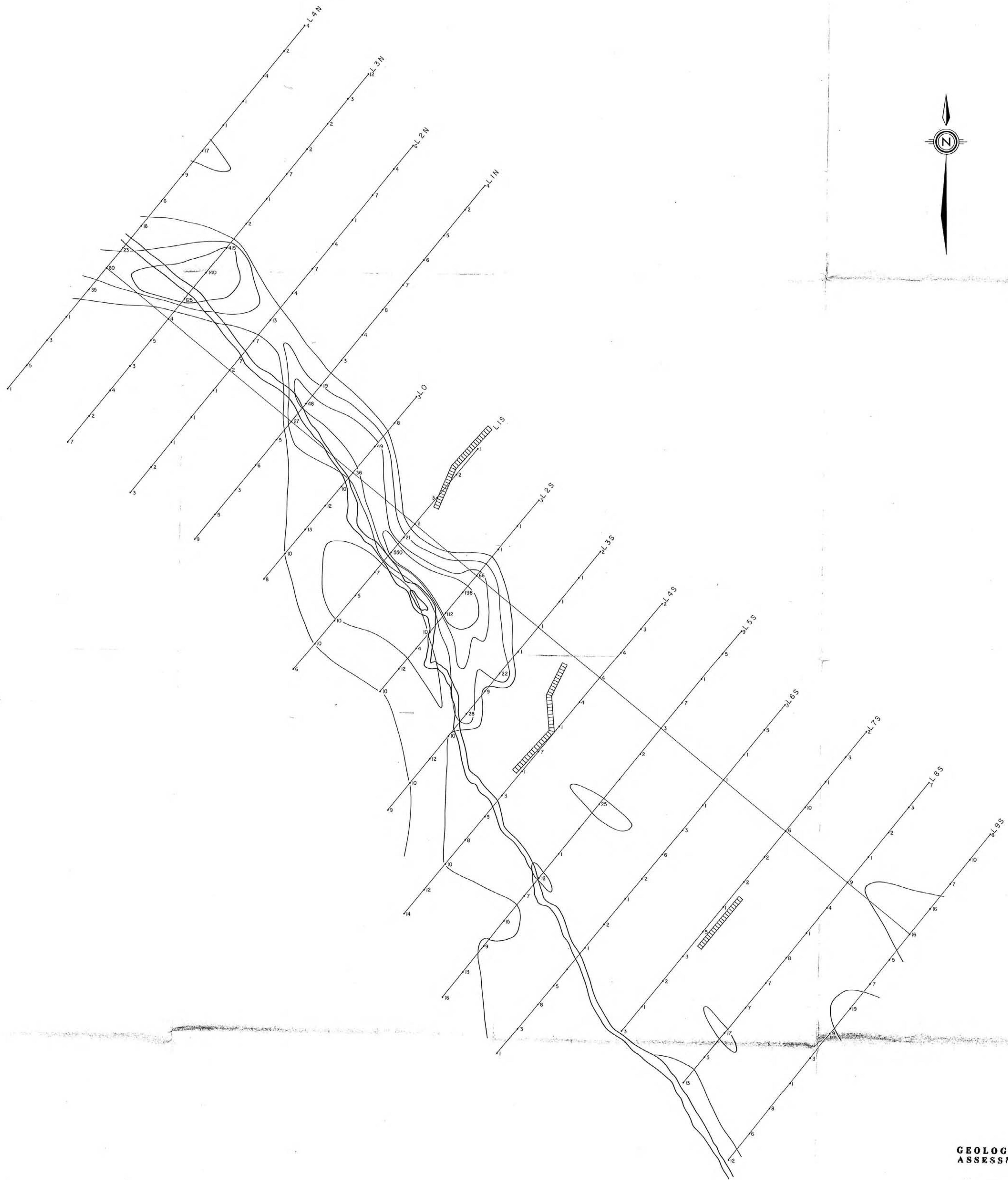

GEOLOGICAL BRANCH  
ASSESSMENT REPORT

12,911

PART 2 OF 2

ST. JOE CANADA INC.

SILVER POND PROPERTY  
SILVER CREEK OCCURRENCE  
SOIL GEOCHEMICAL SURVEY  
GOLD IN PPB

SCALE 1:500  
Metres 0 10 20 30 40 50

LEGEND

- N = 189
- CONTOUR LEVELS
- 10 ppb  $\bar{x}$   $\pm$  SB
- 20 ppb  $\bar{x}$   $\pm$  2(SB)
- 45 ppb  $\bar{x}$   $\pm$  3(A + B)
- 107 ppb  $\bar{x}$   $\pm$  5(A + B)
- $\bar{x}$  = MEAN
- S = STANDARD DEVIATION
- A = ANOMALOUS POPULATION
- B = BACKGROUND POPULATION

