



Ministry of Energy, Mines & Petroleum Resources
Mining & Minerals Division
BC Geological Survey

Assessment Report
Title Page and Summary

TYPE OF REPORT [type of survey(s)]: DC Resistivity

TOTAL COST: 18,800.00

AUTHOR(S): Walcott, A.

SIGNATURE(S): Digital

NOTICE OF WORK PERMIT NUMBER(S)/DATE(S): August 14th-19th,

YEAR OF WORK: 2019

STATEMENT OF WORK - CASH PAYMENTS EVENT NUMBER(S)/DATE(S): 5753225

PROPERTY NAME: Getty South

CLAIM NAME(S) (on which the work was done): 519232,526953

COMMODITIES SOUGHT: Copper, Molybdenum, Gold

MINERAL INVENTORY MINFILE NUMBER(S), IF KNOWN: 092INE052,117,135,111,005,011,030,029.053

MINING DIVISION: KAMLOOPS

NTS/BCGS: 92I/10&11

LATITUDE: 50 ° 33 ' 0 " **LONGITUDE:** 121 ° 02 ' 0 " (at centre of work)

OWNER(S):

1) Getty Copper Inc.

2) _____

MAILING ADDRESS:

1000 Austin Avenue, Coquitlam, B.C.

OPERATOR(S) [who paid for the work]:

1) _____

2) _____

MAILING ADDRESS:

PROPERTY GEOLOGY KEYWORDS (lithology, age, stratigraphy, structure, alteration, mineralization, size and attitude):

Copper, Molybdenum, Guichon, Kamloops, Highland Valley

REFERENCES TO PREVIOUS ASSESSMENT WORK AND ASSESSMENT REPORT NUMBERS: _____

TYPE OF WORK IN THIS REPORT	EXTENT OF WORK (IN METRIC UNITS)	ON WHICH CLAIMS	PROJECT COSTS APPORTIONED (incl. support)
GEOLOGICAL (scale, area)			
Ground, mapping	_____	_____	_____
Photo interpretation	_____	_____	_____
GEOPHYSICAL (line-kilometres)			
Ground			
Magnetic	_____	_____	_____
Electromagnetic	_____	_____	_____
Induced Polarization	_____	_____	_____
Radiometric	_____	_____	_____
Seismic	_____	_____	_____
Other	DC RESISTIVITY	519232,526953	18,800.00
Airborne		_____	_____
GEOCHEMICAL (number of samples analysed for...)			
Soil	_____	_____	_____
Silt	_____	_____	_____
Rock	_____	_____	_____
Other	_____	_____	_____
DRILLING (total metres; number of holes, size)			
Core	_____	_____	_____
Non-core	_____	_____	_____
RELATED TECHNICAL			
Sampling/assaying	_____	_____	_____
Petrographic	_____	_____	_____
Mineralographic	_____	_____	_____
Metallurgic	_____	_____	_____
PROSPECTING (scale, area)		_____	_____
PREPARATORY / PHYSICAL			
Line/grid (kilometres)	_____	_____	_____
Topographic/Photogrammetric (scale, area)	_____	_____	_____
Legal surveys (scale, area)	_____	_____	_____
Road, local access (kilometres)/trail	_____	_____	_____
Trench (metres)	_____	_____	_____
Underground dev. (metres)	_____	_____	_____
Other	_____	_____	_____
		TOTAL COST:	18,800.00

Mineral Titles Online Viewer

Exploration and Development Work / Expiry Date Change Event Detail

Event Number ID	5753225
Recorded Date	2019/aug/29
Work Type	Technical Work (T)
Technical Items	Geophysical (P), PAC Withdrawal (up to 30% of technical work required) (W3)
Work Start Date	2019/aug/14
Work Stop Date	2019/aug/19
Total Value of Work	\$ 15000.00
Mine Permit Number	

Summary of the work value:

Title Numbers	332395
Claim Name/Property	BRAM 2
Issue Date	1994/nov/08
Work Performed Index	N
Old Good To Date	2019/sep/06
New Good To Date	2019/oct/01
Numbers of Days Forward	25
Area in Ha	500.00
Applied Work Value	\$ 512.30
Submission Fee	\$ 0.00
Title Numbers	347448
Claim Name/Property	GETTY #95
Issue Date	1996/jun/16
Work Performed Index	N
Old Good To Date	2019/sep/06
New Good To Date	2019/oct/01
Numbers of Days Forward	25
Area in Ha	400.00
Applied Work Value	\$ 409.84
Submission Fee	\$ 0.00
Title Numbers	352941
Claim Name/Property	GETTY #113
Issue Date	1996/dec/04
Work Performed Index	N

Old Good To Date	2019/sep/06
New Good To Date	2019/oct/01
Numbers of Days Forward	25
Area in Ha	25.00
Applied Work Value	\$ 25.61
Submission Fee	\$ 0.00
Title Numbers	412799
Claim Name/Property	GETTY 2405
Issue Date	2004/jul/17
Work Performed Index	N
Old Good To Date	2019/sep/06
New Good To Date	2019/oct/01
Numbers of Days Forward	25
Area in Ha	25.00
Applied Work Value	\$ 25.61
Submission Fee	\$ 0.00
Title Numbers	412800
Claim Name/Property	GETTY 2406
Issue Date	2004/jul/17
Work Performed Index	N
Old Good To Date	2019/sep/06
New Good To Date	2019/oct/01
Numbers of Days Forward	25
Area in Ha	25.00
Applied Work Value	\$ 25.61
Submission Fee	\$ 0.00
Title Numbers	519232
Claim Name/Property	GETTY SOUTH1
Issue Date	2005/aug/22
Work Performed Index	Y
Old Good To Date	2019/sep/06
New Good To Date	2019/oct/01
Numbers of Days Forward	25
Area in Ha	123.22
Applied Work Value	\$ 126.25
Submission Fee	\$ 0.00
Title Numbers	519235
Claim Name/Property	GETTY SOUTH 2
Issue Date	2005/aug/22
Work Performed Index	N
Old Good To Date	2019/sep/06
New Good To Date	2019/oct/01
Numbers of Days Forward	25
Area in Ha	82.13
Applied Work Value	\$ 28.05
Submission Fee	\$ 0.00
Title Numbers	519237
Claim Name/Property	GETTY SOUTH 3
Issue Date	2005/aug/22

Work Performed Index	N
Old Good To Date	2019/sep/06
New Good To Date	2019/oct/01
Numbers of Days Forward	25
Area in Ha	164.31
Applied Work Value	\$ 112.24
Submission Fee	\$ 0.00

Title Numbers 526953

Claim Name/Property	GSOUTH 1
Issue Date	2006/feb/02
Work Performed Index	Y
Old Good To Date	2019/sep/06
New Good To Date	2019/oct/01
Numbers of Days Forward	25
Area in Ha	143.75
Applied Work Value	\$ 49.10
Submission Fee	\$ 0.00

Title Numbers 543766

Claim Name/Property	GETTY WEST
Issue Date	2006/oct/22
Work Performed Index	N
Old Good To Date	2019/sep/06
New Good To Date	2019/oct/01
Numbers of Days Forward	25
Area in Ha	307.93
Applied Work Value	\$ 210.33
Submission Fee	\$ 0.00

Title Numbers 759702

Claim Name/Property	
Issue Date	2010/apr/28
Work Performed Index	N
Old Good To Date	2019/sep/06
New Good To Date	2019/oct/01
Numbers of Days Forward	25
Area in Ha	164.38
Applied Work Value	\$ 168.42
Submission Fee	\$ 0.00

Title Numbers 759802

Claim Name/Property	
Issue Date	2010/apr/28
Work Performed Index	N
Old Good To Date	2019/sep/06
New Good To Date	2019/oct/01
Numbers of Days Forward	25
Area in Ha	20.54
Applied Work Value	\$ 21.04
Submission Fee	\$ 0.00

Title Numbers 1049939

Claim Name/Property	BLU
---------------------	-----

Issue Date 2017/feb/10
Work Performed Index N
Old Good To Date 2019/sep/06
New Good To Date 2019/oct/01
Numbers of Days Forward 25
Area in Ha 880.77
Applied Work Value \$ 603.27
Submission Fee \$ 0.00

Title Numbers 1049940

Claim Name/Property
Issue Date 2017/feb/10
Work Performed Index N
Old Good To Date 2019/sep/06
New Good To Date 2019/oct/01
Numbers of Days Forward 25
Area in Ha 717.21
Applied Work Value \$ 491.24
Submission Fee \$ 0.00

Title Numbers 1050025

Claim Name/Property
Issue Date 2017/feb/15
Work Performed Index N
Old Good To Date 2019/sep/06
New Good To Date 2019/oct/01
Numbers of Days Forward 25
Area in Ha 2031.17
Applied Work Value \$ 695.61
Submission Fee \$ 0.00

Title Numbers 1050026

Claim Name/Property
Issue Date 2017/feb/15
Work Performed Index N
Old Good To Date 2019/sep/06
New Good To Date 2019/oct/01
Numbers of Days Forward 25
Area in Ha 225.54
Applied Work Value \$ 77.24
Submission Fee \$ 0.00

Title Numbers 1050816

Claim Name/Property
Issue Date 2017/mar/17
Work Performed Index N
Old Good To Date 2019/sep/06
New Good To Date 2019/oct/01
Numbers of Days Forward 25
Area in Ha 1496.52
Applied Work Value \$ 1022.22
Submission Fee \$ 0.00

Title Numbers 1050818

Claim Name/Property
Issue Date 2017/mar/17
Work Performed Index N
Old Good To Date 2019/sep/06
New Good To Date 2019/oct/01
Numbers of Days Forward 25
Area in Ha 1559.46
Applied Work Value \$ 1065.20
Submission Fee \$ 0.00

Title Numbers 1050819

Claim Name/Property
Issue Date 2017/mar/17
Work Performed Index N
Old Good To Date 2019/sep/06
New Good To Date 2019/oct/01
Numbers of Days Forward 25
Area in Ha 738.55
Applied Work Value \$ 504.47
Submission Fee \$ 0.00

Title Numbers 1050820

Claim Name/Property
Issue Date 2017/mar/17
Work Performed Index N
Old Good To Date 2019/sep/06
New Good To Date 2019/oct/01
Numbers of Days Forward 25
Area in Ha 1619.83
Applied Work Value \$ 1106.44
Submission Fee \$ 0.00

Title Numbers 1050821

Claim Name/Property
Issue Date 2017/mar/17
Work Performed Index N
Old Good To Date 2019/sep/06
New Good To Date 2019/oct/01
Numbers of Days Forward 25
Area in Ha 2233.52
Applied Work Value \$ 1525.63
Submission Fee \$ 0.00

Title Numbers 1050822

Claim Name/Property
Issue Date 2017/mar/17
Work Performed Index N
Old Good To Date 2019/sep/06
New Good To Date 2019/oct/01
Numbers of Days Forward 25
Area in Ha 2687.14
Applied Work Value \$ 1835.48
Submission Fee \$ 0.00

Title Numbers	1050823
Claim Name/Property	
Issue Date	2017/mar/17
Work Performed Index	N
Old Good To Date	2019/sep/06
New Good To Date	2019/oct/01
Numbers of Days Forward	25
Area in Ha	1580.21
Applied Work Value	\$ 1079.38
Submission Fee	\$ 0.00
Title Numbers	1050824
Claim Name/Property	
Issue Date	2017/mar/17
Work Performed Index	N
Old Good To Date	2019/sep/06
New Good To Date	2019/oct/01
Numbers of Days Forward	25
Area in Ha	2213.96
Applied Work Value	\$ 1512.27
Submission Fee	\$ 0.00
Title Numbers	1050825
Claim Name/Property	
Issue Date	2017/mar/17
Work Performed Index	N
Old Good To Date	2019/sep/06
New Good To Date	2019/oct/01
Numbers of Days Forward	25
Area in Ha	1312.54
Applied Work Value	\$ 896.54
Submission Fee	\$ 0.00
Title Numbers	1050826
Claim Name/Property	
Issue Date	2017/mar/17
Work Performed Index	N
Old Good To Date	2019/sep/06
New Good To Date	2019/oct/01
Numbers of Days Forward	25
Area in Ha	1929.75
Applied Work Value	\$ 1318.13
Submission Fee	\$ 0.00
Title Numbers	1050827
Claim Name/Property	
Issue Date	2017/mar/17
Work Performed Index	N
Old Good To Date	2019/sep/06
New Good To Date	2019/oct/01
Numbers of Days Forward	25
Area in Ha	2500.33
Applied Work Value	\$ 1707.87

Submission Fee	\$ 0.00
Title Numbers	1050828
Claim Name/Property	
Issue Date	2017/mar/17
Work Performed Index	N
Old Good To Date	2019/sep/06
New Good To Date	2019/oct/01
Numbers of Days Forward	25
Area in Ha	656.58
Applied Work Value	\$ 448.48
Submission Fee	\$ 0.00

Title Numbers	1050829
Claim Name/Property	
Issue Date	2017/mar/17
Work Performed Index	N
Old Good To Date	2019/sep/06
New Good To Date	2019/oct/01
Numbers of Days Forward	25
Area in Ha	450.93
Applied Work Value	\$ 308.01
Submission Fee	\$ 0.00

Title Numbers	1050830
Claim Name/Property	
Issue Date	2017/mar/17
Work Performed Index	N
Old Good To Date	2019/sep/06
New Good To Date	2019/oct/01
Numbers of Days Forward	25
Area in Ha	1149.13
Applied Work Value	\$ 784.93
Submission Fee	\$ 0.00

Title Numbers	1050831
Claim Name/Property	
Issue Date	2017/mar/17
Work Performed Index	N
Old Good To Date	2019/sep/06
New Good To Date	2019/oct/01
Numbers of Days Forward	25
Area in Ha	1149.72
Applied Work Value	\$ 785.33
Submission Fee	\$ 0.00

Financial Summary:

Total Applied Work Value:	\$ 19482.14
PAC name	Getty Copper
Debited PAC amount	\$ 4482.14
Credited PAC amount	\$

Total Submission Fees	\$ 0.00
Total Paid	\$ 0.00

Related Summary:

Existing Work Program
Event Numbers

Click [here](#) to go back to the previous page
Click [here](#) to go back to the titles search page.

**EVENT #5753225
AN ASSESSMENT REPORT**

ON

DC RESISTIVITY SURVEYING

**GETTY PROPERTY
LOGAN LAKE AREA, BRITISH COLUMBIA**

**KAMLOOPS M.D.
50° 33'N, 121° 02'W
NTS 92I/ 10 & 11**

Claims:519232,526953

Work Dates: August 14th-19th, 2019

FOR

**GETTY COPPER INC.
COQUITLAM, BRITISH COLUMBIA**

BY

ALEXANDER WALCOTT, B.Sc

**PETER E. WALCOTT & ASSOCIATES LIMITED
Coquitlam, British Columbia**

DECEMBER 2019

TABLE OF CONTENTS

	<u>Page</u>
INTRODUCTION.....	4
PROPERTY, LOCATION AND ACCESS.....	5
PREVIOUS WORK.....	8
REGIONAL GEOLOGY.....	10
PROPERTY GEOLOGY.....	17
PURPOSE.....	25
GEOPHYSICAL SURVEY SPECIFICATIONS.....	26
DISCUSSION OF RESULTS.....	28
SUMMARY, CONCLUSIONS & RECOMMENDATIONS.....	30

APPENDIX I

Cost of Project
 Personnel Employed On Project
 Certification
 References

TABLE OF CONTENTS cont'd**ACCOMPANYING MAPS**

Claim and Line Location Map	Scale 1:30,000
Detailed Claim and Line Location Map	Scale 1: 1,000
DC Resistivity Pseudosections Line 120S, 160S, 200S, 240S	Scale 1: 1,000
3D Modelled Sections Line 120S, 160S, 200S, 240S	Scale 1: 1,000
Historic Drill Hole Plan with 3D Modelled Slice @ 1600M	Scale 1: 2,000

INTRODUCTION.

Between August 14-19th, 2019, Peter E. Walcott & Associates Limited, undertook detailed DC Resistivity surveying for Getty Copper Inc. on their Getty Property.

The survey was designed to expand on the 2018 DC Resistivity survey which identified several features of interest proximal to the Getty South.

PROPERTY LOCATION AND ACCESS

The Getty property is located some 20 kilometres northwest of the community of Logan Lake, British Columbia.

Access to the core of the property is obtained from Logan Lake, via highway 97C, and then utilizing a series of resources roads throughout the property.

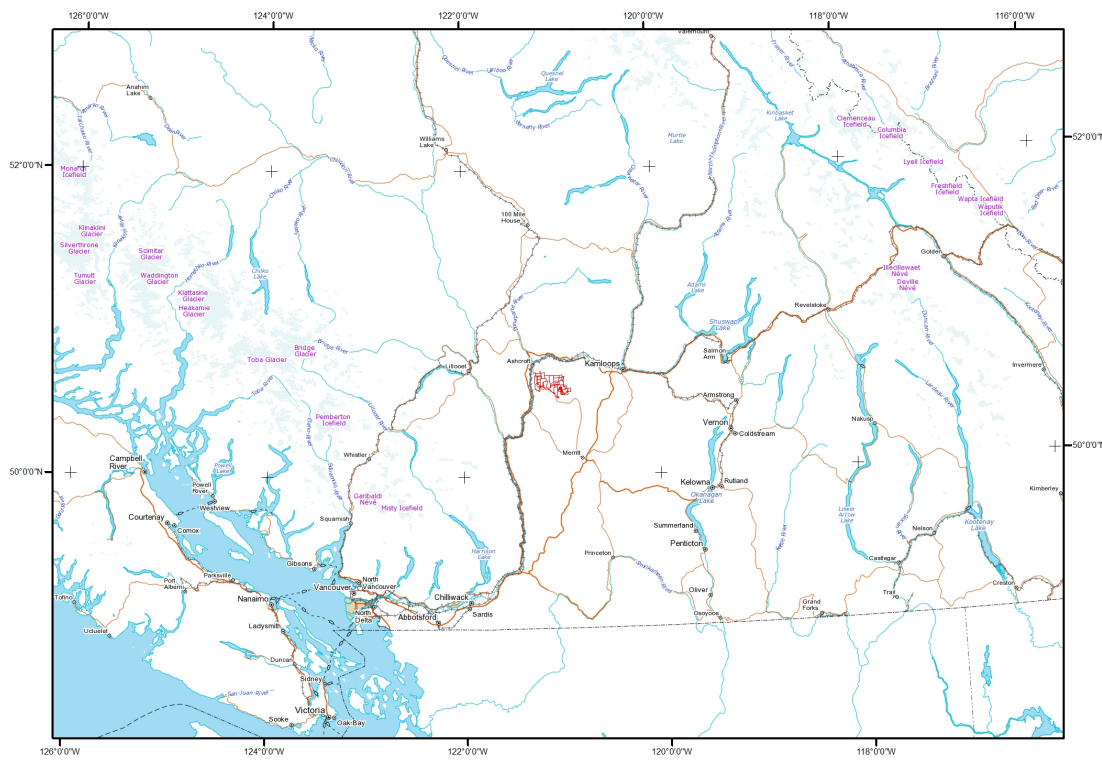

Property Location Map

PROPERTY LOCATION AND ACCESS con't

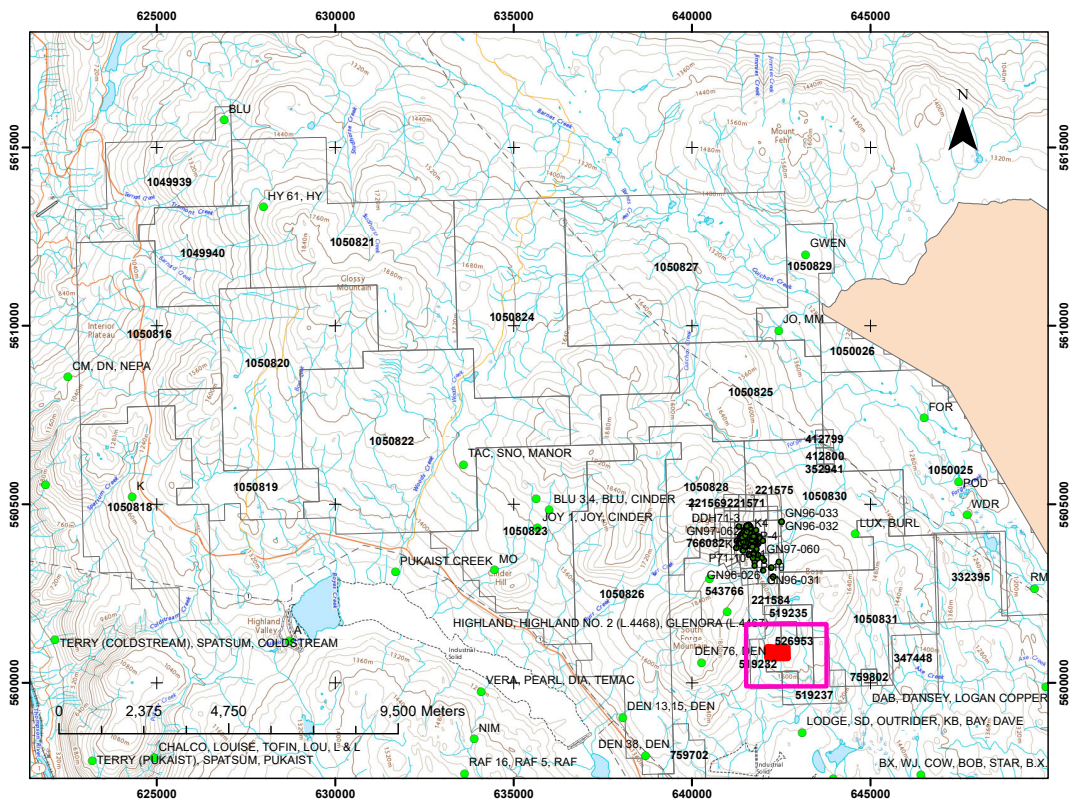

Grid and Claim Location Map

PROPERTY LOCATION AND ACCESS con't

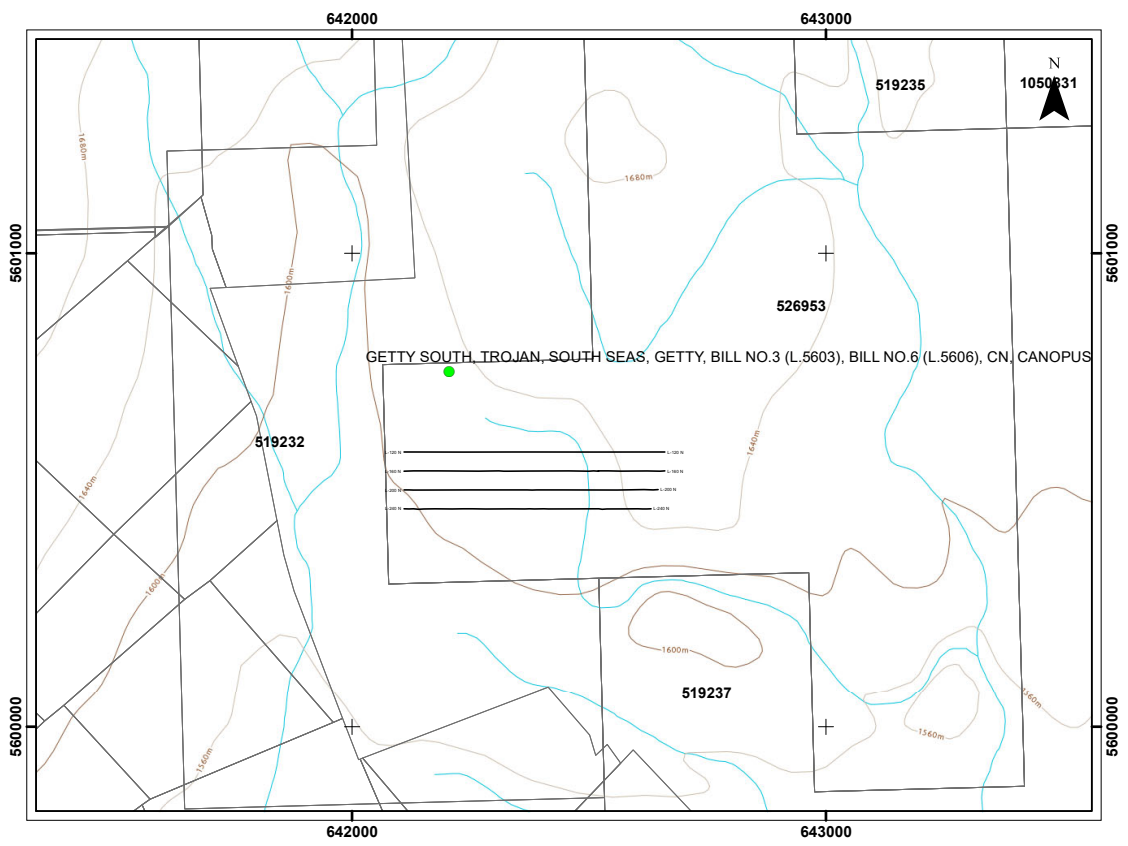

Detailed Grid and Claim Location Map

PREVIOUS WORK.

Early exploration in the Highland Valley area was sparked in the 1890's by discovery of the Alwin deposit and the original showings at the Bethlehem deposit. Efforts were aimed at exploiting high-grade bornite-chalcopyrite veins through the 1920s at past-producing deposits that include Berthsaida, Alwin, Snowstorm and Aberdeen. Significant exploration for low-grade porphyry deposits did not begin until the mid-1950s with an increase in the price of copper. Bethlehem Copper Corporation, in conjunction with American Smelting and Refining Company (ASARCO), conducted extensive exploration which led to the first open pit copper production from the Bethlehem deposit, between 1962 and 1982. Subsequent exploration throughout the 1960s-1980s led to the discovery of additional producers, Lornex, Highmont and Valley, as well as the smaller JA, Minex and Ann Number 1 deposits and, on the Getty property, the Getty North and Getty South deposits. Production commenced during the 1970s and 1980s at Lornex (1972), Highmont (1980) and Valley (1983) and culminated in the amalgamation of the founding companies to form the Highland Valley Copper Partnership in 1985.

Exploration on the Getty property has been focused on the Getty North and Getty South deposits and has defined sizeable resources in each area, as described in the Mineral Occurrences section. The nearby Getty West zone has also received significant work. Initial exploration circa 1905 included short adits and shafts. Work undertaken to outline the resources began in about 1955 and over a period of more than 50 years included soil sampling, trenching, magnetometer and induced polarization surveys, extension of underground workings and a number of programs of diamond and percussion drilling. Several assessment reports are available documenting the results of these programs.

Exploration on the remainder of the property has seen some detailed work undertaken on the Glossie and Highland prospects, which included short adits and shafts circa 1905 and, later, a few diamond drill holes. At Glossie in 1915 a 1.5 m wide vein was excavated in several pits and 20 tonnes of hand-sorted material was shipped to a smelter. More widespread coverage on the property has comprised geochemical and geophysical programs, geological mapping and a few exploration drill holes that have tested targets at a number of sites throughout the property: Hy 61 - Minfile 092INW013 (percussion holes in 1977), Tac - Minfile 092INW005 (3 diamond drill holes in 1968), Mo - Minfile 092INW053 (1 diamond drill hole in 1973), Joy 1 and Blu 3 - Minfile 092INW029-030 (2 diamond drill holes, 10 percussion holes in 1973), Lux - Minfile 092INE151 (8 diamond drill holes in 1965, 2 holes in 1984), Gwen - Minfile 092INE084 (3 diamond drill holes in 1994).

PREVIOUS WORK con't.

More recent work has primarily utilized geophysical and geochemical techniques over large parts of the property to attempt to identify new targets at depth or beneath overburden cover. In 2004 Teck Cominco Limited undertook high powered IP surveying within the central and western parts of the property. Selected IP chargeability targets were geologically evaluated and 19 diamond drill holes tested several of them. Typically the chargeability anomalies were found to be caused by Tertiary volcanic rocks containing pyrite or Nicola volcanic rocks that have been locally hornfelsed, with disseminated pyrite and pyrrhotite. Several holes passed through the cap of Tertiary rocks and into underlying Guichon granodiorite, cut locally by dykes of the Bethlehem phase, however, the results were generally disappointing, with only minor copper mineralization near dykes.

In 2010 a Titan-24 DC/IP and MT survey was conducted in the areas of the Getty North, South and West deposits. The instrumentation is capable of measuring resistivity and conductivity up to 750 m depth. The known mineral deposits were well defined by the survey and in total thirty-nine geophysical anomalies were identified, of which twelve are classified as high priority drill targets for possible deposit extensions.

In 2015 an airborne magnetic survey totaling 1825 line-km was flown over the entire Getty property. Magnetic features of interest were identified and were to be correlated with geological and geochemical targets in a compilation of property-wide data. Also in 2015, a 16 line-km, deep-penetrating IP survey was undertaken near Getty West to better define a target identified by the 2010 Titan survey. A moderate chargeability high was defined beneath drill hole 96GL-08 that had returned 0.26% Cu over 42 metres.

In early 2017, detailed airborne magnetics were carried out over the Glossie and Pod areas.

In 2018, Geophysical work proximal to the Getty North, West and South and Glossie were undertaken. This consisted of detailed ground magnetics, gravity, DC Resistivity and 3D inversion of historic MT data.

The author would refer the reader to the BC Ministry of Energy and Mines – Assessment Report Indexing System (ARIS) <http://www.empr.gov.bc.ca/mining/geoscience/aris> for the historic public reports.

REGIONAL GEOLOGY

The regional geology surrounding the Getty property is dominated by the Guichon Creek batholith, which is intrusive into and, in the earliest phase, possibly comagmatic with the Late Triassic Nicola Group. The Nicola Group is primarily comprised of submarine volcanic rocks of island-arc affinity and associated sedimentary rocks within the southern portion of the Quesnel Trough which is a 30-km to 60-km wide northwest-trending belt extending from southern B.C. into the southern Yukon. Prominent high-angle, north-trending faults can be traced along the length of the Nicola Group and are likely basement structures that provided magmatic conduits and focused the construction of the volcanic centers (Preto et al., 1979).

The Nicola Group has been subdivided into three distinct, north-south-trending belts in the southern Quesnel terrane that are often separated by high-angle Triassic and Tertiary faults (Preto, 1979; Monger, 1985). The western belt of the Nicola Group is comprised predominantly of basalt and rhyolite flows and volcanoclastic rocks interbedded with subordinate limestones, whereas the central and eastern belts are dominated by subaerial and submarine augite-phyric basalt and andesite flows, breccias and lahars with interbedded limestones, with an increasing proportion of sedimentary rocks to the east (Mortimer, 1987). The Guichon Creek batholith has intruded the western and central belts of Nicola Group rocks. To the northwest of the batholith, fault bounded slices of Cache Creek Complex flank the Nicola Group. These slices include units of limestone and calcareous sedimentary rocks, as well as serpentinized ultramafic rocks.

Two younger volcanic-dominated successions are important in the area. First, along the southwest flank of the batholith, a northwest trending belt of Cretaceous continental volcanic and sedimentary rocks of the Spences Bridge Group unconformably overlie Nicola Group and older country rocks and possibly a small part of the batholith. The rock types are primarily amygdaloidal andesite, lesser amounts of dense andesite, mafic volcanic breccia and epiclastic rocks.

REGIONAL GEOLOGY cont'd.

Secondly, to the north of, and partially overlying the north end of the batholith, are continental volcanic and sedimentary rocks of the Eocene Kamloops Group. These include basalt, andesite, dacite, trachyte and rhyolite, with related tuffs and breccias and minor amounts of mudstone, shale, sandstone and conglomerate. These rocks are also found as isolated fault-bounded outliers and local possible intrusive centers south of the Highland Valley.

The Guichon Creek batholith is a Late Triassic, north-northwest trending, composite intrusion measuring approximately 60 km long by 25 km wide, consisting of four major phases that form roughly concentric rings, ranging inward from oldest to youngest. The batholith evolved over a period of 7 million years and the sizeable Highland Valley mineral deposits are found within the two latest intrusive phases, which may have been formed from distinct magma batches derived from different source compositions than the earlier phases (Whalen, Davis & Anderson, 2017).

The batholith phases were emplaced by a combination of sidewall and roof stoping, forceful intrusion and assimilation of older rock. Therefore, there are a variety of contacts between phases, including sharp intrusive contacts, contacts defined by dyke-like bodies and brecciated contacts. Contacts between two phases, although generally intrusive, may be gradational in some parts of the batholith (Northcote, 1968). The oldest phase shows contamination by assimilation of wallrocks, resulting in a wide range of textures and compositions. Where intruded into Nicola Group rocks there is a 0.2-0.8 km wide albite-epidote to hornblende hornfels facies metamorphic aureole. Inner uncontaminated phases have orderly compositional and textural variations and are generally coarser grained.

The four phases are described by McMillan (1976) as follows:

- 1). The oldest outer Border, or Hybrid, Phase is well foliated tonalite and minor hornblende, mafic diorite, quartz-diorite and quartz-monzodiorite, and carries country rock inclusions in its outer sections and as a consequence of contamination, ranges from amphibolite to monzonite in composition;

REGIONAL GEOLOGY cont'd.

2). The Highland Valley Phase, which comprises the Guichon variety, primarily in the north, (quartz diorite to granodiorite which normally contains 15% mafic minerals, mainly hornblende and biotite which are present in equal amounts, but distributed as clusters) and the Chataway variety (normally a granodiorite, with 12% evenly distributed mafics, which are predominantly hornblende and minor biotite). The two varieties have intercalated, gradational contacts which are not intrusive;

3). The Bethlehem Phase, which is also a granodiorite, is characterized by 8% mafic minerals, with several percent of coarse grained hornblende in a matrix containing evenly distributed, fine to medium mafic crystals. The Skeena Variety is also a granodiorite with a similar composition, occurring in the south of the main Bethlehem Phase;

4). The Bethsaida Phase, which varies from quartz monzonite to granodiorite and has a gradational boundary with the Bethlehem Phase. This forms the innermost, youngest and most leucocratic core and is unfoliated and porphyritic.

The batholiths of the Guichon Suite are elongated in a north-northwest direction, suggesting structural control by pre- or syn-plutonic faults. Important faults in the batholith trend north (e.g., Lornex and Guichon Creek faults) or northwest (e.g., Barnes Creek, Highland Valley and Skuhun Creek faults). The Valley and Lornex deposits exhibit many similarities and may have been structurally controlled and (or) later offset by up to 6 km of dextral movement along Lornex and Highland Valley faults (McMillan, 1976).

The Highmont orebody is located along the Highmont fault, which continues to the north where it apparently is associated with the JA, Bethlehem, Getty South and Getty North deposits in turn. The Highland Valley fault; and the interpreted Dupuis Creek fault which joins it at of the widest part of the Highland valley, represent a major northwest structural zone close to the center of the Highland Valley mining district. The JA copper deposit is elongated parallel to this zone beneath a thick cover of surficial material. The former Alwin mine is located adjacent to a north-south fault located west of the Highland Valley copper deposits.

REGIONAL GEOLOGY cont'd.

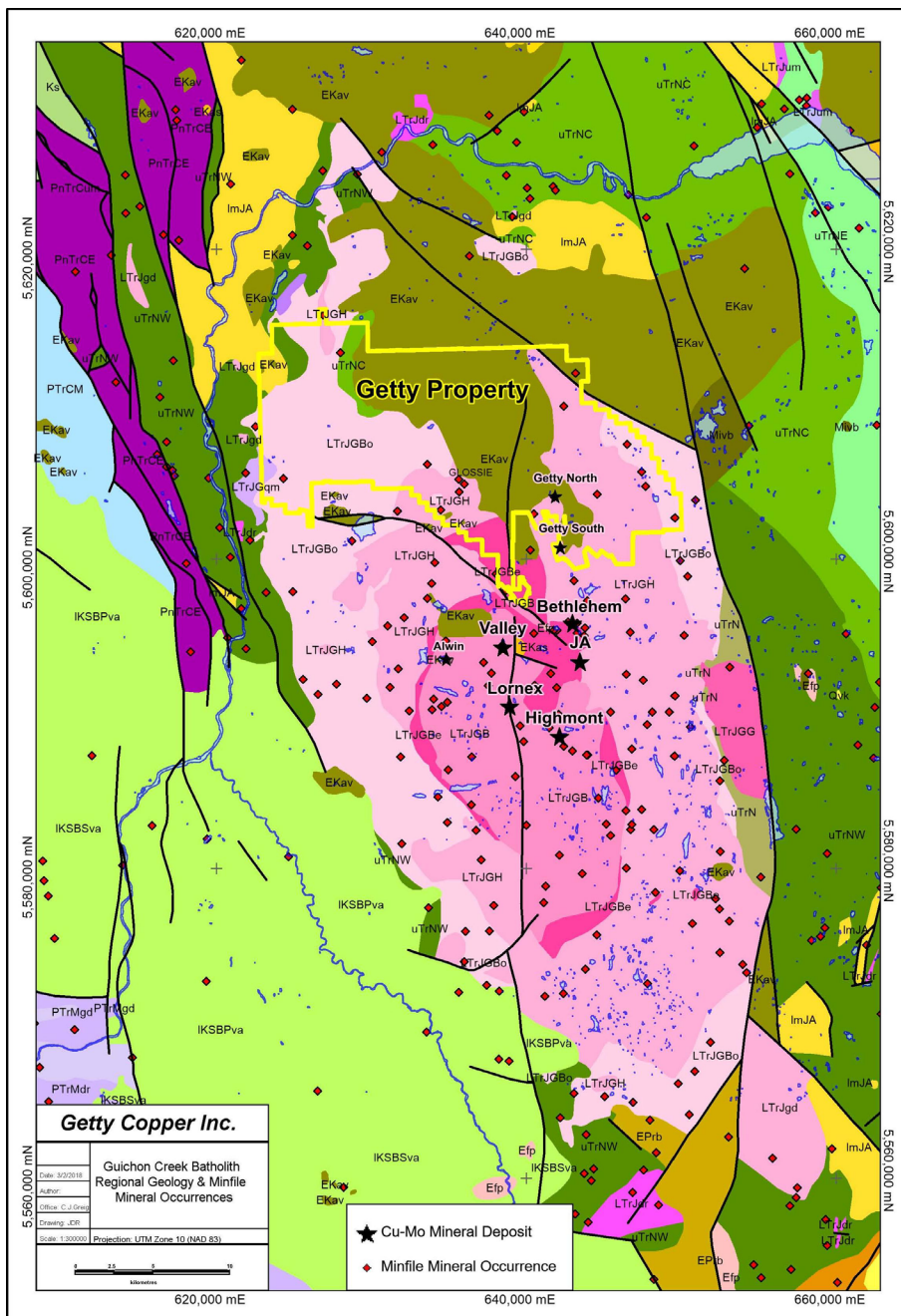

Getty property regional geology with Minfile mineral occurrences and Cu-Mo deposits (see fig. x for geologic legend) (source Massey et al., 2005)

REGIONAL GEOLOGY cont'd.

Guichon Creek Batholith Area Geologic Legend

	LTrJGB - Mesozoic - Guichon Creek Batholith - Bethsaida Phase quartz monzonitic intrusive rocks
	LTrJGBe - Mesozoic - Guichon Creek Batholith - Bethlehem Phase granodioritic intrusive rocks
	LTrJGH - Mesozoic - Guichon Creek Batholith - Highland Valley Phase granodioritic intrusive rocks
	LTrJGBo - Mesozoic - Guichon Creek Batholith - Border Phase quartz dioritic intrusive rocks
	LTrJGqm - Mesozoic - Guichon Creek Batholith quartz monzonitic intrusive rocks
	LTrJdr - Mesozoic - Unnamed dioritic intrusive rocks
	PnTrCE - Paleozoic to Mesozoic - Cache Creek Complex - Eastern Belt serpentinite ultramafic rocks
	PTrMgd - Paleozoic to Mesozoic - Mount Lytton Complex granodioritic intrusive rocks
	Qvk - Cenozoic - Unnamed alkaline volcanic rocks
	Mivb - Cenozoic - Unnamed basaltic volcanic rocks
	EKav - Cenozoic - Kamloops Group undivided volcanic rocks
	EPr - Cenozoic - Princeton Group undivided sedimentary rocks
	EPrb - Cenozoic - Princeton Group andesitic volcanic rocks
	Ks - Mesozoic - Unnamed undivided sedimentary rocks
	IKSBPva - Mesozoic - Spences Bridge Group - Pimainus Formation andesitic volcanic rocks
	ImJA - Mesozoic - Ashcroft Formation mudstone, siltstone, shale fine clastic sedimentary rocks
	uTrN - Mesozoic - Nicola Group undivided volcanic rocks
	uTrNE - Mesozoic - Nicola Group - Eastern Volcanic Facies basaltic volcanic rocks
	uTrNC - Mesozoic - Nicola Group - Central Volcanic Facies andesitic volcanic rocks
	uTrNW - Mesozoic - Nicola Group - Western Volcanic Facies undivided volcanic rocks
	PTrCM - Paleozoic to Mesozoic - Cache Creek Complex - Marble Canyon Formation limestone, marble, calcareous sedimentary rocks

Geologic legend

REGIONAL GEOLOGY cont'd.

Almost all of the mineralization in the district occurs along fractures, and fracture density is considered to be the most important factor influencing ore grade (Casselmann et al, 1995). North-south and east-west fracturing appear to be dominant.

The Guichon Creek batholith is interpreted from gravity features to be a funnel-shaped body extending to depths of about 10 km (Roy and Clowes, 2000). Except for the Valley-Lornex deposits which are off-set to the west of the gravity-low stem by approximately 5 km, the Highland Valley mineral deposits are located in the center of the structure above the stem of the batholith and near the intersection of major brittle structures.

The Highland Valley District, the largest porphyry camp in Canada, has produced as of 2013, approximately 6.5 Mt of Cu, with remaining proven and probable ore reserves of 546.6 Mt averaging 0.29% Cu and 0.008% Mo (<http://www.teck.com/media/2017-AIF.pdf>).

Copper and copper-molybdenum showings are dispersed through the batholith, but the important deposits are associated with late dyke swarms to the north of Highland Valley, or occur in or near the contact of the Bethsaida (youngest) phase and related dykes. According to McMillan (1985), there were two porphyry deposit-forming events within the Guichon Creek batholith, an earlier pre-Bethsaida event that produced the predominantly Cu, with negligible Mo, Bethlehem ore bodies, as well as the smaller Getty North and Getty South deposits, and a second more significant post-Bethsaida event, during which the Cu-Mo bearing Valley, Lornex, and Highmont deposits formed.

The mines of the Highland Valley copper district, which lie between 3 and 9 kilometres south of the Getty property, are obvious target models for exploration on the property. These are the largest producers of copper in Canada, and they generate a substantial tonnage of molybdenum as well. The Highland Valley mines are classified as porphyry copper-molybdenum deposits of the calc-alkaline type. These large orebodies (150 million- to more than one billion-tonnes) appear to be spatially associated with regional faults, but that are not obviously aligned along faults.

REGIONAL GEOLOGY cont'd.

The copper minerals are bornite and chalcopyrite and pyrite is present, although not abundant in the ore. The total sulphide content of an orebody may be less than 2% and the mineralized zones are not enriched in magnetite. The average ore grade depends to some extent on copper price but generally falls within the range of 0.40 to 0.45%. Intrusive rocks of the Bethlehem phase, and to a lesser extent adjacent rocks of the Highland Valley phase, which are present on the southern and eastern parts of the Getty property, are the preferential target areas for exploration.

PROPERTY GEOLOGY

The east and west parts of the Getty property are underlain primarily by intrusive rocks of the Guichon Creek batholith, whereas the central part is covered by a capping of Eocene volcanic rocks that are most likely underlain by Guichon Creek rocks at indeterminate depths (fig. x). In the northwest corner of the property northerly trending strips of Upper Triassic Nicola Group rocks flank the batholith and also form inliers and pendants within the intrusions. The Nicola Group rocks are divided into western and central belts. The western belt is comprised predominantly of basalt and rhyolite flows and volcanoclastic rocks interbedded with subordinate limestones, whereas the central belt contains subaerial and submarine basalt and andesite flows, breccias and lahars with interbedded limestones. Elsewhere in the region, copper mineralization is found within Nicola Group rocks and, although there is one minor occurrence on the property (Hy 61) located at the Nicola contact, areas underlain by these rocks are not known to provide any significant exploration targets at Getty.

Geological mapping was undertaken by Oliver (2001) within the Glossie area, in the west-central part of the property, and this mapping has been merged with the BCMEM digital map (Massey et al., 2005) on Figure x. Oliver (2001) defined various intrusive rock types, some of which belong to the Border phase and some of which are likely Highland Valley phase (Guichon variety). He also identified an area of quartz-feldspar porphyry dykes that may correspond to Bethlehem phase intrusions. The Getty North and South deposits, located 5 to 10 km to the southeast are hosted in similar environments, where mineralization is associated with felsic porphyry dykes cutting Highland Valley phase quartz diorite. Outside of the Getty North / South deposits area, this west-central area (Glossie), as well as the south-central tip of the property, appear to have the highest potential for discovery of new copper deposits because of the presence of Bethlehem phase batholith and felsic dykes of possible Bethlehem affinity cutting Highland phase intrusions.

Oliver (2001) noted that his unit QD/GD (fig. x), comprised of oxide enhanced quartz diorites and granodiorites, contains many magnetite rich inclusions and locally hosts stockwork veinlets and veins, sometimes stained with copper oxides. Four Minfile mineral occurrences are located within this unit.

A large percentage of the Getty property is covered by glacial till ranging in thickness from less than a metre to more than 10 metres in places. Oliver (2001) noted that low level soil anomalies in the Glossie area may reflect the nature of surficial geological relationships, more than the strength and quality of the bedrock anomaly, therefore, areas of broad lower order anomalies should be investigated.

PROPERTY GEOLOGY cont'd.

Faulting has been noted in several areas of the property. The major Lornex fault appears to continue from the Lornex and Valley mines north through the Getty property, although it is mainly cutting Eocene volcanic rocks, having apparently been re-activated post-Eocene. Airborne magnetic results (this report) define northwesterly and north-northeasterly structures in the Glossie area that show correlation with copper-in-soil anomalies. Oliver (2001) mapped sizeable faults in the Glossie area that have orientations of 100° and 130°, which he noted are similar in style and form to the Highland Valley Fault system and would run approximately sub-parallel to this fault system, but about 2 km's to the north.

The south-central tip of the property also appears to be a very prospective area for mineralization; however, overburden is extensive making detection difficult. The area is mapped as favourable Bethlehem phase quartz diorites, which are cut by the prominent Lornex fault. There are two Minfile mineral occurrences mapped just west of the property boundary in this area. Den 13, 15 (Minfile 092INW032) and Den 38 (Minfile 092INW014) are both described as underlain by Bethlehem phase and Guichon variety (Highland Valley phase) quartz diorite that is locally faulted and sheared and contains small aplite and/or quartz porphyry dikes. Weakly disseminated bornite, chalcopyrite and malachite occur in and along northeast joints in quartz diorite host rocks.

Mineral Occurrences

The **Getty North** (also called Krain) deposit (Minfile 092INE038) has been described in detail by others (Niessen & Gower, 1996) (Parkinson & Fayram, 2009) and the reader is referred to those reports for more comprehensive descriptions.

The Getty North deposit lies on the southern boundary of an extensive area covered by post-mineral Eocene Kamloops Group volcanic and sedimentary rocks. Mineralization occurs within quartz diorites of the Highland Valley phase (Guichon variety) of the batholith, and within younger anastomosing dikes and small stocks that resemble quartz diorites of the Bethlehem phase. The Kamloops Group rocks cover the northern half of the mineralized zone, protecting an oxidized cap as much as 100 metres thick.

The mineralized porphyry system occurs within a broad northwest-trending zone characterized by numerous sub-parallel, northwest-trending porphyry dikes, as well as by prominent chlorite-epidote- chalcopyrite ±pyrite ±bornite hydrothermal veins and fracture selvages. Smaller zones of pervasive chlorite-clay alteration, some containing strong chalcopyrite mineralization, occur frequently at the margins of porphyry dikes.

PROPERTY GEOLOGY cont'd.

Mineralization and alteration are closely associated with an elongate, 1000 x 200 metre, dyke-like stock at the center of the deposit that resembles Bethlehem phase rocks. Fracturing, brecciation, alteration and mineralization are most strongly developed in and around the core and along the upper surface of the stock.

Within the core and near the contacts of the stock, chalcopyrite-bornite assemblages are found associated with molybdenite-bearing quartz veinlets. Peripheral to this mineralization, chalcopyrite-pyrite assemblages occur in fracture stockwork fillings in which pyrite becomes more abundant outward, both within the wall rocks and the stock. Maximum total sulphide content is approximately 5%. The deposit measures 400 metres long by 300 metres wide and extends to 450 metres depth. The zone appears to be cut off by a fault to the northwest; the northeast and south boundaries are near vertical.

Fractures and faults are prominent. The areas of highest fracture density, which are adjacent to the stock, are also the zones of best mineralization. Sets of steeply dipping north and northeast-trending faults are dominantly post-mineralization.

Alteration varies outward from sericite-clay-chlorite assemblages in the core, through clay-chlorite and chlorite assemblages in the chalcopyrite zone, to chlorite-epidote assemblages in the pyrite zone. Disseminated calcite forms as much as 5% of the more highly altered and better mineralized rocks.

From 1955 to 1997 several programs of drilling, totalling 302 holes, produced a systematic drill grid over the deposit on northeast-oriented sections, 30 metres apart. In 2010 a 43-101 compliant resource calculation determined an estimate of 87.4 million drill indicated and inferred tonnes grading 0.35% Cu and 0.005% Mo, which included both oxide and sulphide ores.

The **Getty South** (also called South Seas or Trojan) deposit (Minfile 092INE043) lies on the southern boundary of an extensive area covered by post-mineral Eocene Kamloops Group volcanic and sedimentary rocks. The deposit occurs along a broad northwest trend, which hosts a number of mineralized systems, including the Getty North deposit, 3 km to the north, and the Bethlehem deposit, about 5 km south. Typically, mineralization occurs within quartz diorites of the Highland Valley phase (Guichon variety) of the Guichon Creek batholith, and within younger anastomosing dykes and small stocks that resemble quartz diorites of the Bethlehem phase. The Kamloops Group rocks cover the northern half of the mineralized zone, which includes an oxidized cap as much as 100 metres thick.

PROPERTY GEOLOGY cont'd.

The Getty South deposit occurs within a breccia zone just east of a major, north-striking regional fault, called the Bethlehem Fault. The breccia-hosted deposit is elliptical in shape and measures 575 x 550 metres. It is thought to be a multi-stage breccia that consists of fragments of quartz diorite and feldspar porphyry set in a matrix of finely broken rock, specular hematite, tourmaline, brown biotite, quartz and calcite. Closely associated with breccia zones are a series of closely spaced (10-50 m separation) felsic dykes. Chalcopyrite occurs as stringers and coarse blebs in the breccia matrix. Bornite, native copper, malachite, chrysocolla, azurite and tenorite have also been reported. Alteration assemblages are similar to those described above for the Getty North deposit.

Northerly, northwesterly and northeasterly striking faults and fractures dominate the structural fabric of the region. The faults developed prior to mineralization and have been periodically reactivated. They apparently channeled hydrothermal fluids into faulted, fractured and brecciated sites where they deposited metallic minerals. Both the Getty South and Getty North deposits appear to share the same structural controls and appear to be similarly mineralized.

Over the last 60 years exploration at Getty South has included 19,003 meters of surface diamond drilling (at least 118 holes), 1158 meters of underground diamond drilling, 1719 meters of underground drifting and a two-compartment shaft with a total depth of 49 meters. All underground development has been confined to the 49-meter level ("150 Level").

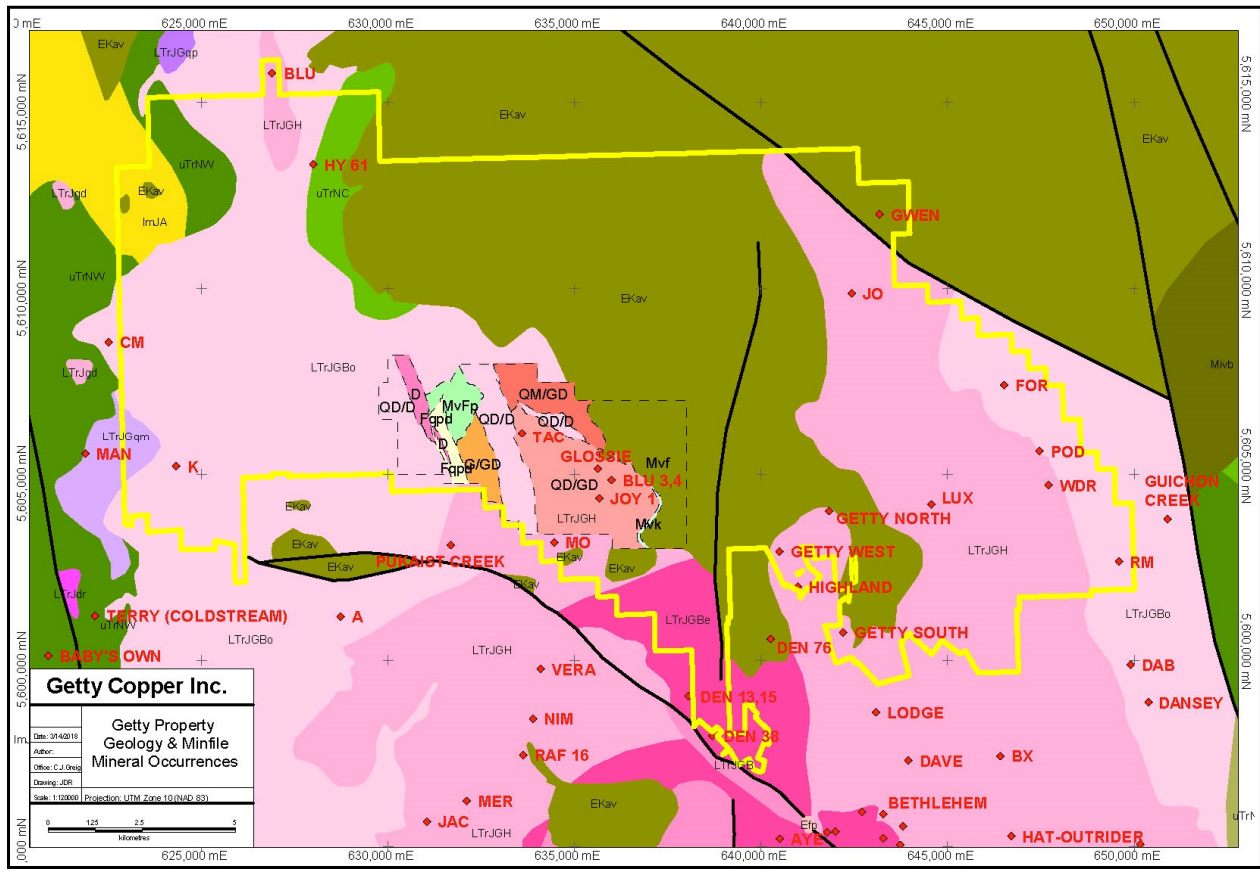

In 2010 a 43-101 compliant resource calculation for the Getty South deposit determined an estimate of 68.74 million drill indicated and inferred tonnes grading 0.34% Cu and undetermined Mo, which included both oxide and sulphide ores.

PROPERTY GEOLOGY cont'd.









Getty property geology and Minfile mineral occurrences
(sources Massey et al., 2005, Oliver, 2001)

PROPERTY GEOLOGY cont'd.**Glossie Area Geology Legend*****EOCENE***

- Mvf  **Basaltic -Andesitic Flows**
Maroon to grey, fine grained, weakly vesicular sub-areal flows.
Locally well developed flow laminations.
- Mvk  **Debris Flows**
Yellow green to maroon, poorly sorted heterolithic
debris flows; un-stratified.

TRIASSIC INTRUSIVE ROCKS

- FgPd  **Felsic Dykes**
Fine grained quartz +/- plagioclase porphyritic dykes,
with heavy secondary matrix silica.
Pyrite disseminated at low levels, <2%.
Probable Bethlehem phase correlate.
- G/GD  **Granites/Granodiorites**
Very potassium feldspar rich (>10%) granites to
granodiorites. Biotite greater than hornblende,
quartz greater than 10%.
- QM/GD  **Quartz Monzonites and Granodiorites**
Intrusive rocks containing mafic phases, biotite > hornblende
to 15%, quartz 5-10% and modest, < 5-8% potassium feldspar.
- QD/GD  **Oxide Enhanced Quartz Diorites and Granodiorites**
Rocks varying in composition from granodiorites to quartz diorites.
Oxide, magnetite content, often slightly elevated. Probable correlate
with transitional members, Highland Vallley to Guichon phases.
- QD/D  **Quartz Diorite to Diorites**
Mafic rich, hornblende > biotite to 20%, intermediate intrusions.
Quartz < 5%, plagioclase > 70%.
- D  **Diorites**
Mafic rich , > 30% hornblende > biotite, mafic intrusions,
with crowded glomerular plagioclase. No free quartz.
Epidote - chlorite veins common.
- Mv/Fp  **Hornfelsed Mafic Volcanics**
Hornfelsed strongly altered mafic volcanic rocks with
lesser feldspar porphyritic dykes. Secondary amphibole,
garnet, biotite, magnetite and pyrite common (Mv).
Hornfelsed plagioclase porphyritic phases (Fp).

Geology legend

PROPERTY GEOLOGY cont'd.

Three Minfile occurrences on the property are classed as prospects. Two are located between Getty North and Getty South and have received moderate exploration activity. **Getty West** (also called Transvaal) (Minfile 092INW040) is 1.7 km southwest of Getty North.

The **Getty West** zone is underlain by Highland Valley phase (Guichon variety) quartz diorite, which has been intruded by Bethlehem phase quartz diorite porphyry dikes and stocks. Numerous intensely altered, well-mineralized granitic crush zones are exposed at the surface and one of the zones has been traced in a north-south direction for 91 metres.

Veins, occurring in fractures and joint planes, consist of black, sooty tourmaline, quartz and fractured wallrock mineralized with minor amounts of azurite, malachite, chrysocolla, chalcopryrite, chalcocite, hematite and magnetite. The veins range in width from 0.5 cm to 1 m, but are generally less than 30 cm, and the length of any one continuous section of a vein is not more than 6 metres.

Drilling in 1997 at Getty West intersected significant oxide and sulphide copper mineralization, indicating that both types of mineralization are more widespread than previously indicated by surface and underground showings. For instance, one 42 metre intersection returned 0.26% copper and 0.02% molybdenum.

The **Highland** prospect (Minfile 092INW041) is located 2.2 km southwest of Getty North. The geologic setting is very similar to that at Getty West with fine veins in fractured Guichon variety quartz diorite and Bethlehem phase dykes. Short underground workings and several drill holes have tested the mineralized zone.

The third Minfile prospect is the **Glossie** showing (Minfile 092INW011) that is located 6.3 km west-northwest from Getty North. It is also underlain by Highland Valley phase quartz diorite, cut by a small plug of quartz feldspar porphyry. Fracture controlled mineralization found in veins and as fracture coatings consists of bornite, chalcopryrite, chalcocite, azurite, malachite, chrysocolla, tetrahedrite, melanterite, pyrite and specular hematite. Predominant gangue minerals are quartz, tourmaline and calcite. Thin section study of veins shows several stages of fracturing and vein formation.

Alteration zones 1 to 30 centimetres wide, surrounding veins, consist of sericite, carbonate and pink K-feldspar. A grab sample from the dump at the eastern shaft returned 3.9% copper, 15.45 g/t silver and 0.62 g/t gold (Geology, Exploration and Mining in British Columbia 1974). The underground workings were developed to follow a 1.5 m wide vein that strikes 110°, dipping 70° north.

PROPERTY GEOLOGY cont'd.

Fourteen additional minor Minfile showings are located on the property, primarily near the Glossie prospect and along the east side of the property. They are hosted by either the Border phase or Highland Valley phase quartz diorite or granodiorite. At the showings, sparse sporadic copper mineralization occurs in fine veins within fracture zones that have locally associated chlorite, sericite and K-feldspar alteration. Some have been tested by geochemical and geophysical surveys and limited drilling.

PURPOSE.

The purpose of the 2019 DC resistivity survey to expand on the 2018 survey tracking several features potentially associated with mineralized structures identified during the 2018 DC Resistivity program.

.

.

SURVEY SPECIFICATIONS

The DC Resistivity Survey.

The DC Resistivity Survey was conducted using a pulse type system, the principal components of which were manufactured by Advanced Geosciences Inv. of Austin, Texas.

The system consists of a single unit which incorporates the transmitter, receiver and automated switching box. The transmitter, which provides a maximum of 800 w D.C. to the ground, and obtains its power from a 1 kw 60 Hz Honda generator. The cycling rate of the transmitter is 2 seconds “current-on” and 2 seconds “current-off” with the pulses reversing continuously in polarity. The data recorded in the field consists of careful measurements of the current (I) in amperes flowing through the current electrodes C₁ and C₂, the primary voltages (V) appearing between any two potential electrodes, P₁ through P₅, during the “current-on” part of the cycle.

The apparent resistivity (ρ_a) in ohm metres is proportional to the ratio of the primary voltage and the measured current, the proportionality factor depending on the geometry of the array used. The resistivity is called apparent as they are values which that portion of the earth sampled would have if it were homogeneous. As the earth sampled is usually inhomogeneous the calculated apparent resistivity are functions of the actual chargeability and resistivity of the rocks.

The surveying was carried out using the “dipole-dipole” method of survey utilizing a pre-laid receiver array remaining stationary, the current C₁ and C₂ are moved along the survey lines at a spacing of “a” (the dipole) apart.

The survey measuring the 1st to 12th separations. Additional separations were also recorded when feasible.

SURVEY SPECIFICATIONS cont'd.

The distance, “na” between C₂ and the nearest potential electrode generally controls the depth to be explored by the particular separation, “n”, traverse. On this survey a 10 metre dipole separation was utilized.

On this survey a total of some 2.2 kilometres of survey traverses were completed.

Horizontal and Vertical control.

The horizontal and vertical positions of the stations were established using a Hemisphere S320 GNSS RTK System capable of providing centimetre accuracy in both horizontal and vertical component.

The system uses a fixed GNSS base station and radio link to provide correction information to the rover.

Data Presentation.

The data are presented as individual pseudo section plots of apparent resistivity and apparent chargeability at a scale of 1:1,000 generated using Geosoft Oasis Montaj. In addition, data was subjected to both 2D and 3D inversion and presented as model sections at a scale of 1: 1,000.

DISCUSSION OF RESULTS.

The 2019 DC Resistivity survey carried out over portions of the Getty South prospect met with limited success. To determine if the features carried further south, survey lines started in the south working north. A gap was unfortunately left between the 2018 and 2019 survey due to fiscal constrains

Features identified in the 2019 survey were not as prevalent as the 2018 survey. In the western portion of the grid, a moderate west dipping conductive zone can be observed.

A large resistivity high can be observed in the central portion of the grid, truncated in the east by a north-south trending fault structure, which can also be readily observed in the 2018 data.

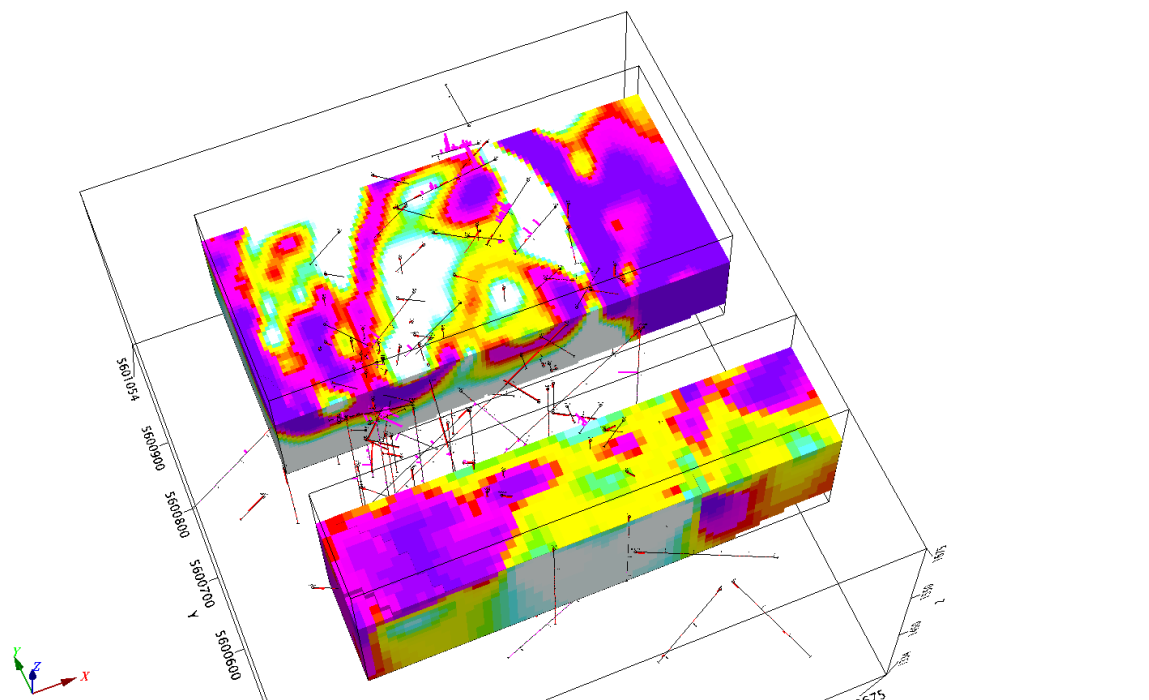

3D Model of Resistivity
1600 m Elevation

DISCUSSION OF RESULTS cont'd.

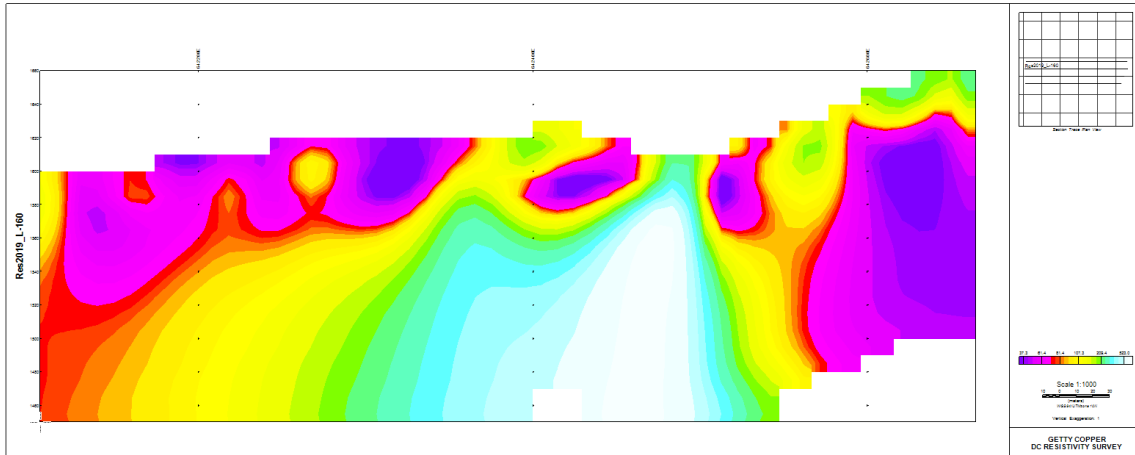

3D Modelled Resistivity – Line 160S

SUMMARY, CONCLUSIONS & RECOMMENDATIONS.

Between August 14th and 19th, 2019, Peter E. Walcott & Associates Limited a small geophysical program over parts of the Getty Property.

The geophysical program consisted of detailed DC Resistivity, carried out on 4 east westerly orientated lines to the south of the 2018

The surveys were designed to aid in developing exploration targets outside of known drilling and evaluate the use of detailed resistivity to identify structures of potential importance.

The surveys identified several structures and features of interest; however several infill lines through the center portion of the survey area need to be completed in order to track a NW trending structure observed in the 2018 data.

Respectfully submitted,

PETER E. WALCOTT & ASSOCIATES LIMITED

**Alexander Walcott, B.Sc.
Geophysicist**

Coquitlam, B.C.

December 2019

APPENDIX I

COST OF PROJECT.

Peter E. Walcott & Associates Limited undertook the DC Resistivity surveying on a daily rate, for a cost of \$12,800.00. A mobilization cost of \$4,000.00, accommodation and fuel charges of \$1,500.00, and reporting for \$500.00 thus bringing the total cost of the project to \$18,800.00.

PERSONNEL EMPLOYED OF PROJECT

Name	Occupation	Address	Dates
A. Walcott	Geophysicist	Unit 111-17 Fawcett Rd. Coquitlam, B.C. V3K 6V2	
J. Cornock	“	“	August 14 th -19 th , 2019
W. Kennedy	Geophysical Operator	“	“
F. Cavallin	“	“	“

CERTIFICATION.

I, Alexander Walcott, of 38-181 Ravine Dr., Port Moody, British Columbia, hereby certify that:

1. I am a graduate of the University of Alberta with a B.Sc. Earth Sciences Major, with a Physics Minor.
2. I have been active in mineral exploration for the past 20 years.
3. I hold no interest, direct or indirect, in the property, nor do I expect to receive any.

Alexander Walcott

**Coquitlam, B.C.
December 2019**

REFERENCES.

- Bergey, W.R.. 2009, Geological Report on the Highland Valley Property, Prepared for Gary Brown, ARIS Report 31016.
- Casselman, M.J., McMillan, W.J., and Newman, K.M., 1995. Highland Valley porphyry copper deposits near Kamloops, British Columbia: A review and update with emphasis on the Valley deposit: Porphyry Deposits of the Northwestern Cordillera of North America: The Canadian Institute of Mining and Metallurgy, Paper 8, p.161 191.
- McMillan, W.J., 1976, Geology and genesis of the Highland Valley ore deposits and the Guichon Creek Batholith, Canada, in Sutherland Brown, A., ed., Porphyry deposits of the Canadian Cordillera, Canadian Institute of Mining and Metallurgy, Special Volume 15, p.85-104.
- McMillan, W.J., 1985, Geology and ore deposits of the Highland Valley Camp: Geological Association of Canada, Mineral Deposits Division, Field Guide and Reference Manual Series, Number 1, 121 p.
- Massey, N.W.D., MacIntyre, D.G., Desjardins, P.J. and Cooney, R.T., 2005. Digital Geology Map of British Columbia: Whole Province. British Columbia Ministry of Energy and Mines, British Columbia Geological Survey Geofile 2005-1, 1:250,000 scale.
- Monger, J.W.H., 1985. Structural evolution of the southwestern Intermontane belt, Ashcroft and Hope map areas, British Columbia. In Current research, part A. Geological Survey of Canada, Paper 85-1A, pp. 349-358.
- Mortimer, N., 1987 The Nicola Group: Late Triassic and Early Jurassic subduction-related volcanism in British Columbia. In Canadian Journal of Earth Sciences, 1987, 24(12): 2521-2536, <https://doi.org/10.1139/e87-236>
- Niessen, V. and Gower, S., 1996. Report on Diamond Drilling on the Getty North Property, Prepared for Getty Copper Corp., ARIS Report 24371.
- Northcote, K.E., 1968. Geology and Geochronology of the Guichon Creek Batholith, B.C., A Thesis Submitted in Partial Fulfilment of the Requirements for the Degree of Doctor of Philosophy, The University of British Columbia.

REFERENCES cont'd.

Oliver, J. 2001. Report on the Geology of the North Valley and Glossie Mineral Occurrences, Prepared for Getty Copper Corporation, ARIS Report 26763.

Parkinson, C.L. and Fayram, T.S., 2009. Preliminary Feasibility Study Technical Report of the Getty Copper Project, Prepared for Getty Copper Inc., ARIS Report 31541.

Preto, V.A., 1979. Geology of the Nicola Group Between Merritt and Princeton; B.C. Ministry of Energy, Mines and Petroleum Resources, Bulletin 69, 90 pages.

Preto, V.A., Osatenko, M.J., McMillan, W.J. and Armstrong, R.L., 1979. Isotopic Dates and Strontium Isotopic Ratios for Plutonic and Volcanic Rocks in the Quesnel Trough and Nicola Belt, South-central British Columbia; Canadian Journal of Earth Sciences, Volume 16, pages 1658-1672.

Roy, Baishali & Clowes, Ron, 2000. Seismic and potential-field imaging of the Guichon Creek batholith, British Columbia, Canada, to delineate structures hosting porphyry copper deposits. Geophysics. 65. 10.1190/1.1444831.

Whalen, J.B., Davis, W.J. and Anderson, R.A., 2017. Temporal and geochemical evolution of the Guichon Creek Batholith and Highland Valley porphyry copper district, British Columbia: Implications for generation and tectonic setting of porphyry systems; Geological Survey of Canada, Open File 8334.

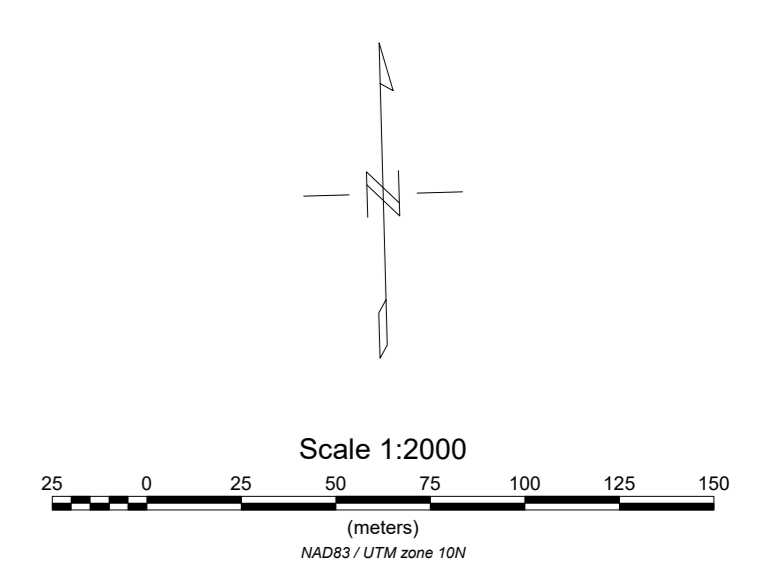
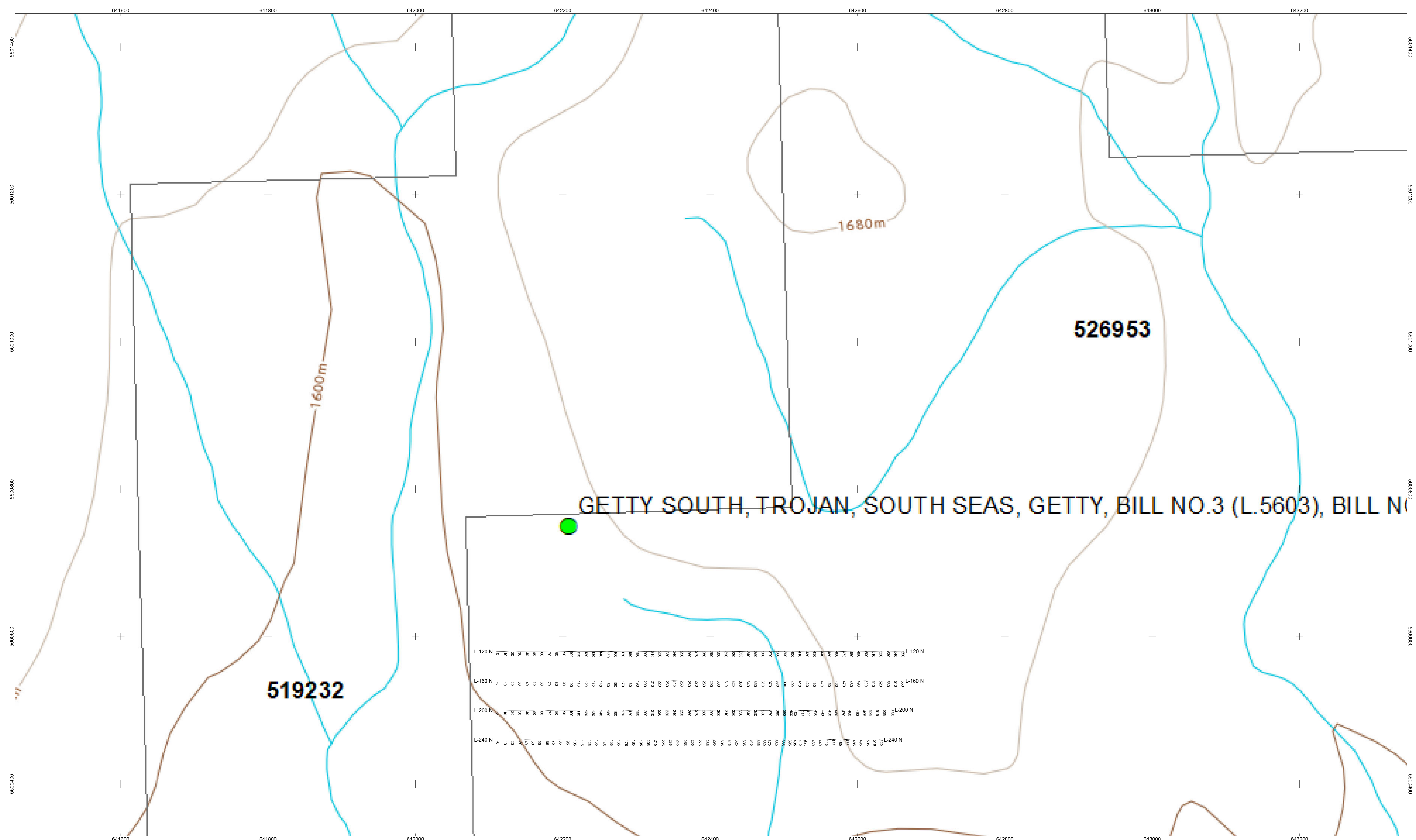

GETTY COPPER INC.
 DC RESISTIVITY SURVEY
 CLAIM AND LINE LOCATION MAP
 GETTY PROPERTY,
 LOGAN LAKE AREA,
 B.C.
 DECEMBER 2019
 PETER E. WALCOTT & ASSOCIATES LIMITED

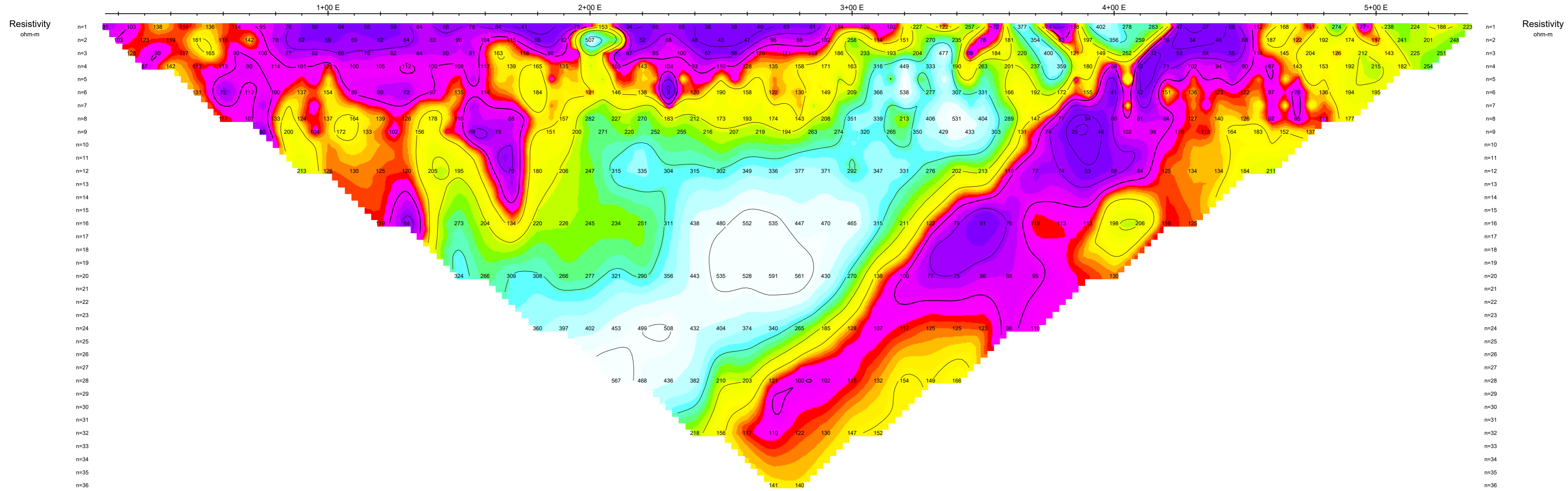

**Pseudo Section Plot
1+20 S**

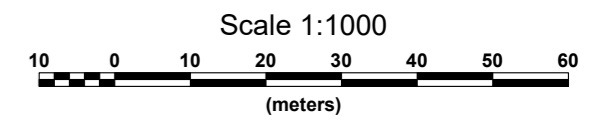
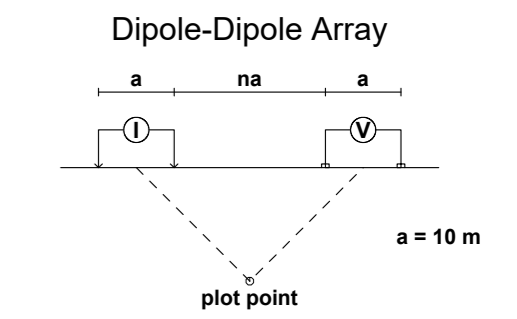

GETTY COPPER
DC RESISTIVITY SURVEY
GETTY SOUTH PROPERTY
LOGAN LAKE, B.C.

Interpretation:
PETER E. WALCOTT & ASSOCIATES LIMITED

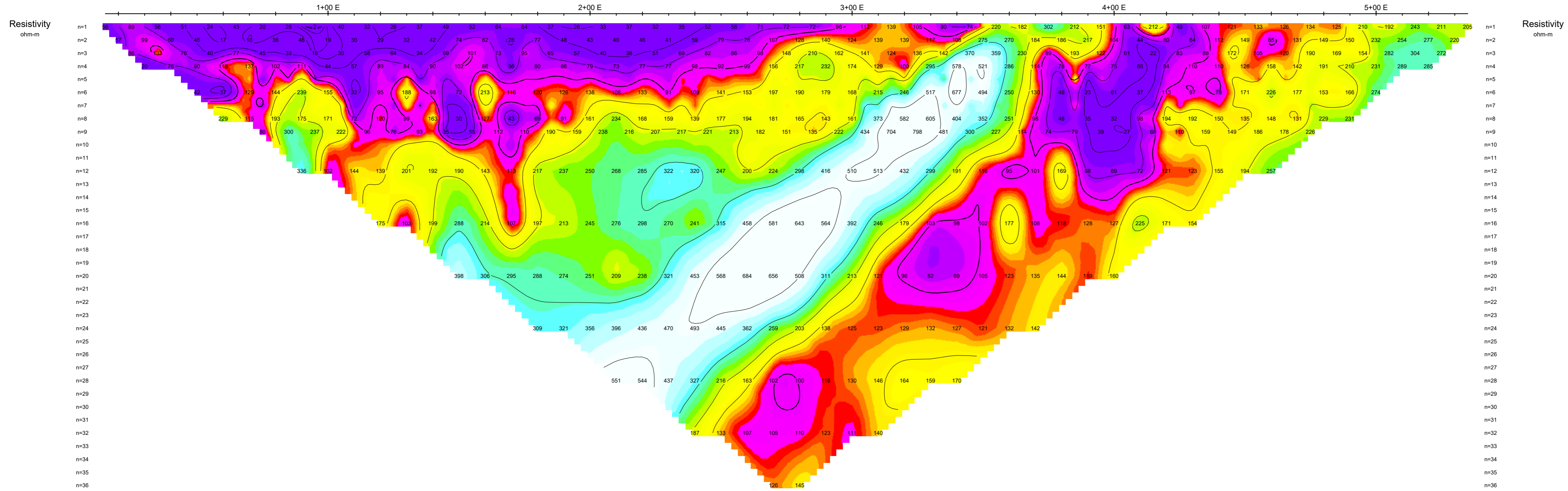

**Pseudo Section Plot
1+60 S**

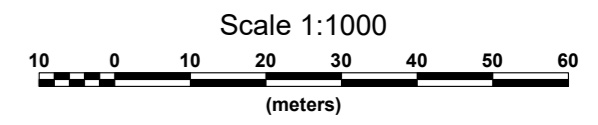
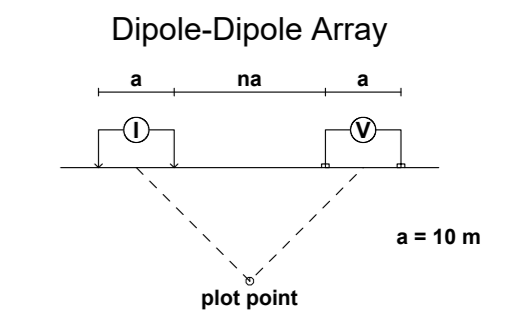

GETTY COPPER
DC RESISTIVITY SURVEY
GETTY SOUTH PROPERTY
LOGAN LAKE, B.C.

Interpretation:
PETER E. WALCOTT & ASSOCIATES LIMITED

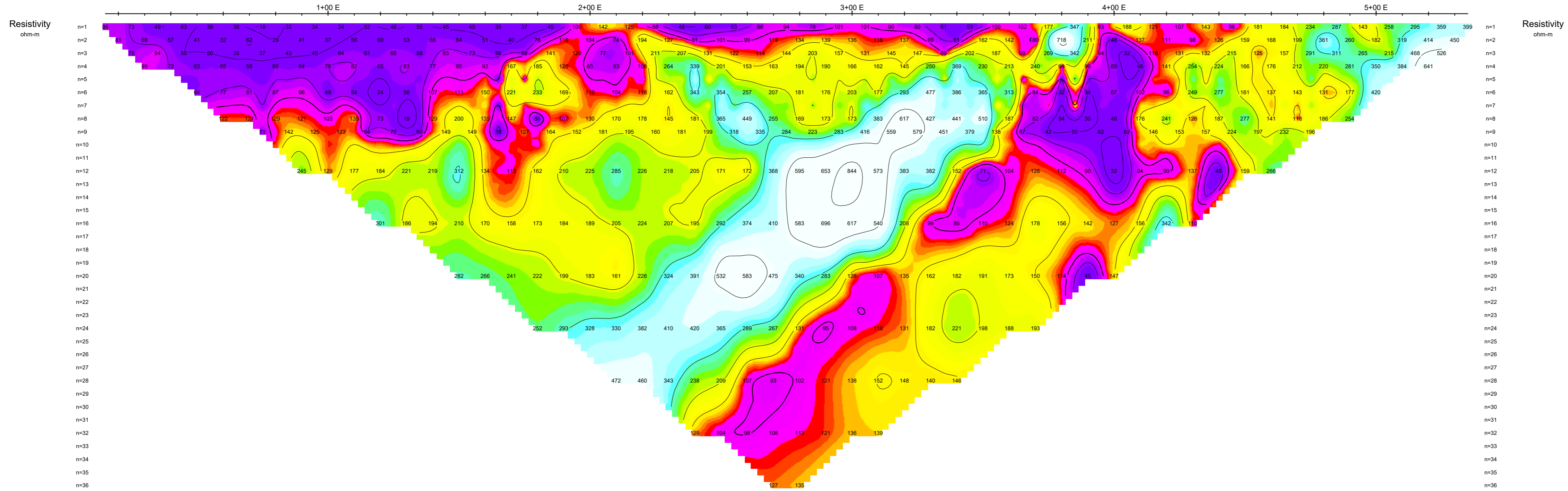

**Pseudo Section Plot
2+00 S**

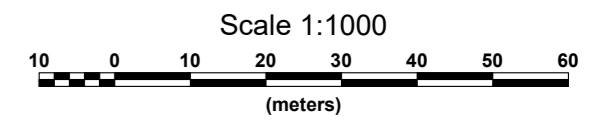
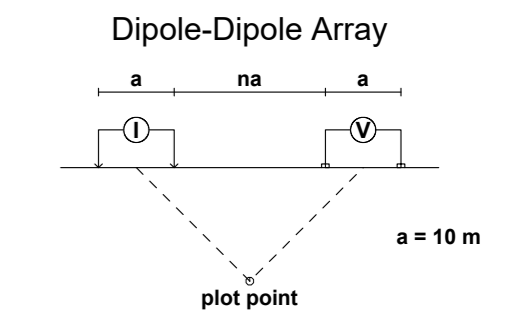

GETTY COPPER
DC RESISTIVITY SURVEY
GETTY SOUTH PROPERTY
LOGAN LAKE, B.C.

Interpretation:
PETER E. WALCOTT & ASSOCIATES LIMITED

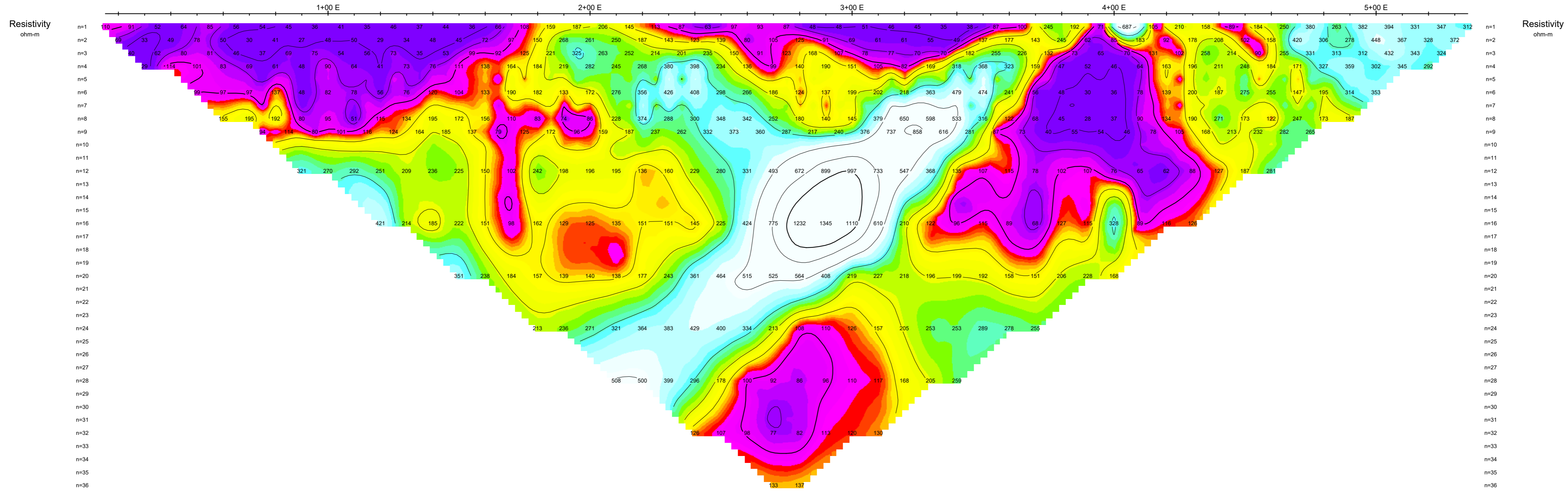

**Pseudo Section Plot
2+40 S**

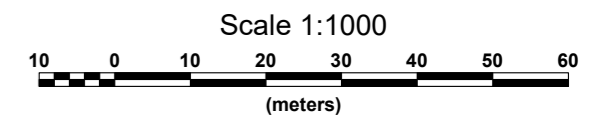
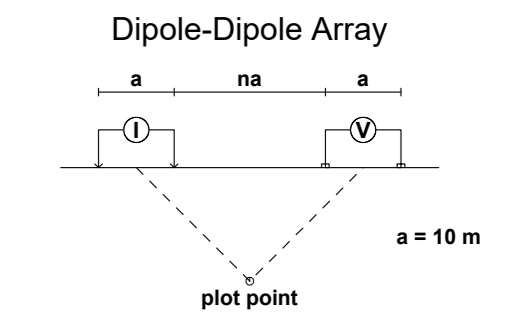

GETTY COPPER
DC RESISTIVITY SURVEY
GETTY SOUTH PROPERTY
LOGAN LAKE, B.C.

Interpretation:
PETER E. WALCOTT & ASSOCIATES LIMITED

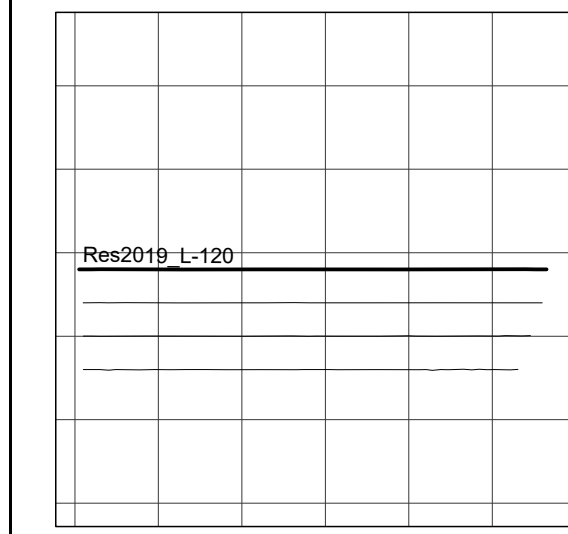
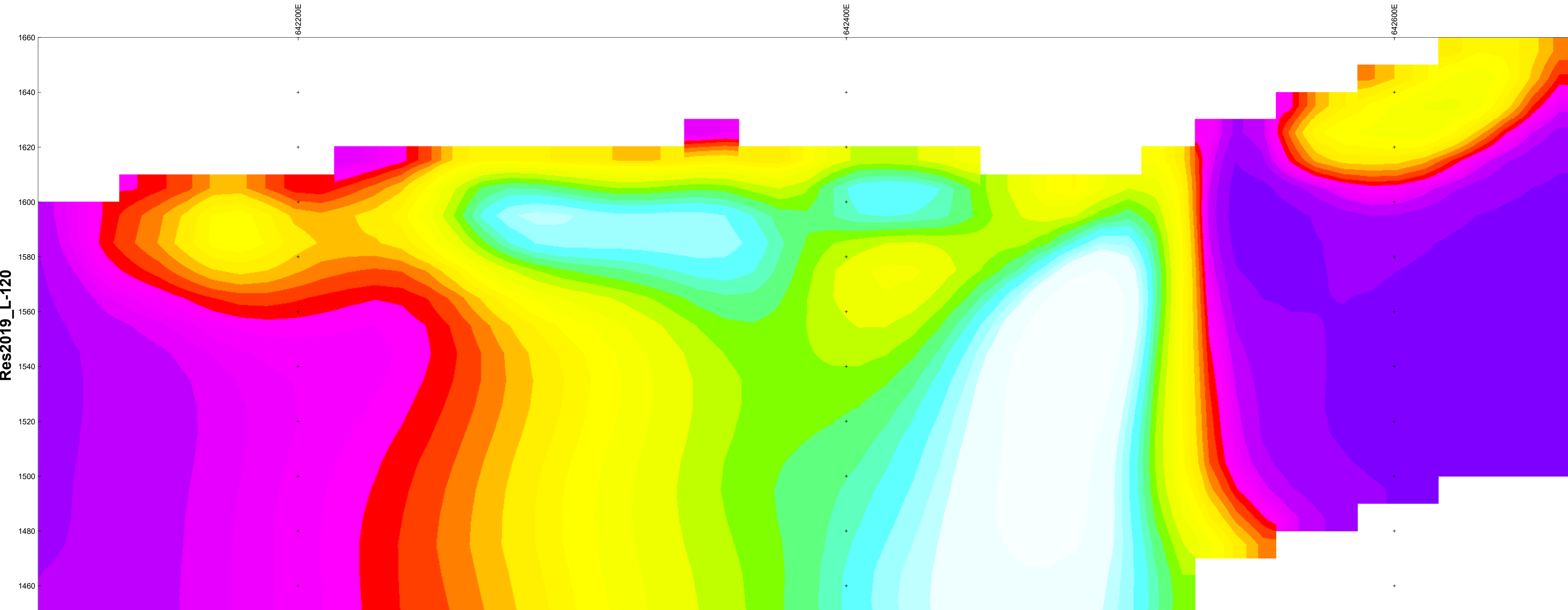

Section Trace Plan View

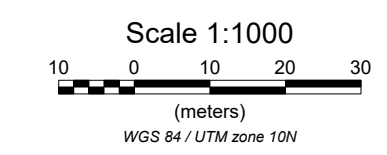
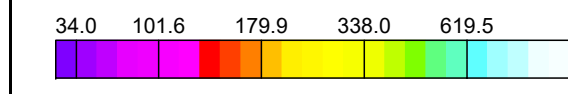

Vertical Exaggeration: 1

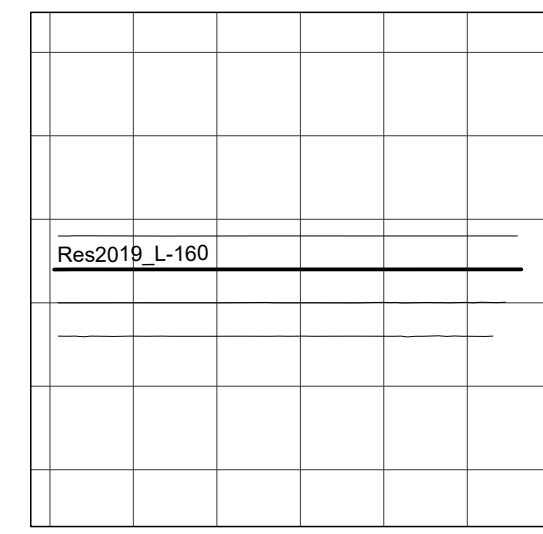
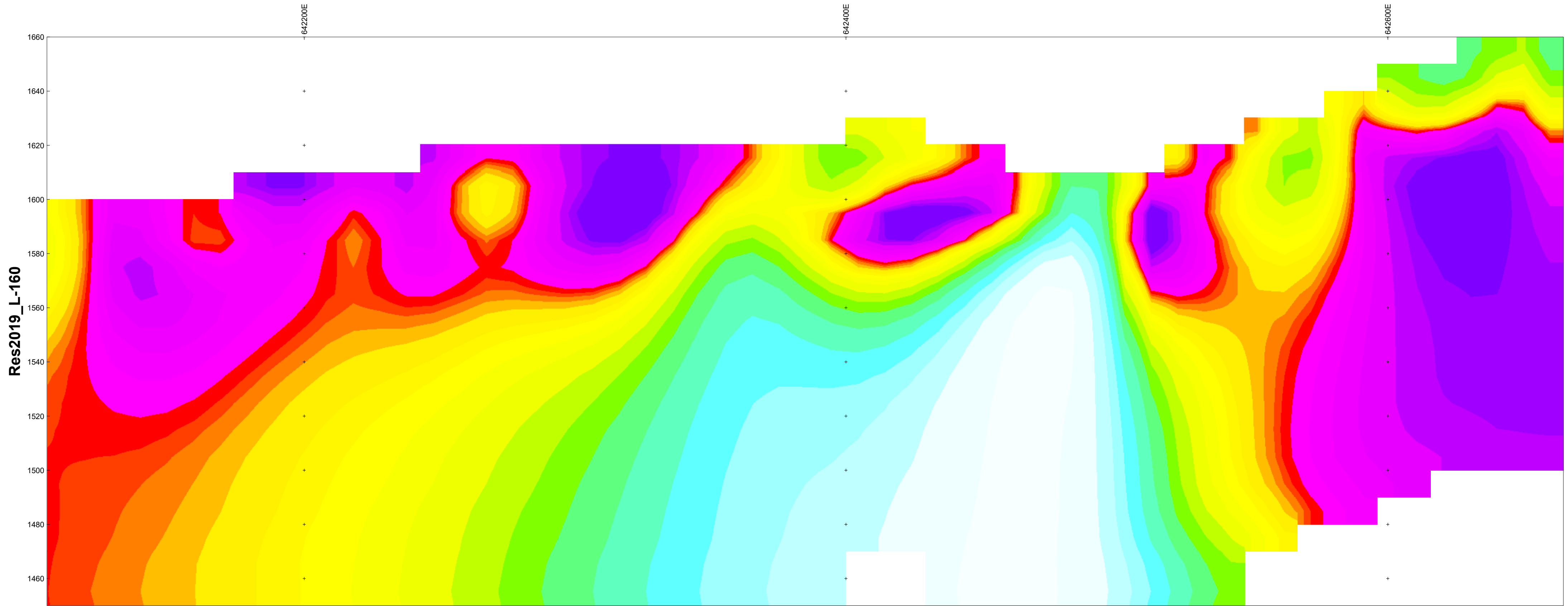

Section Trace Plan View

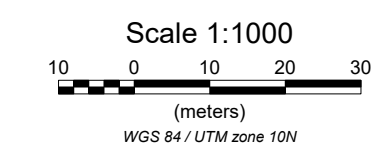
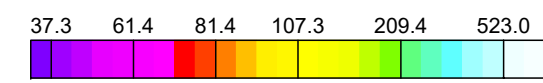

Vertical Exaggeration: 1

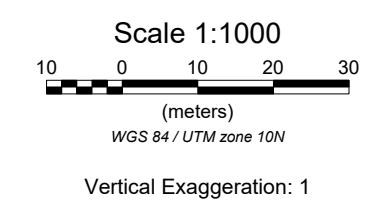
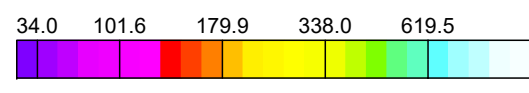
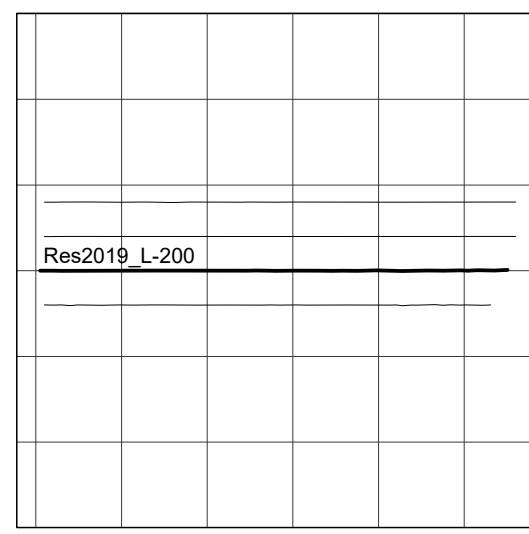
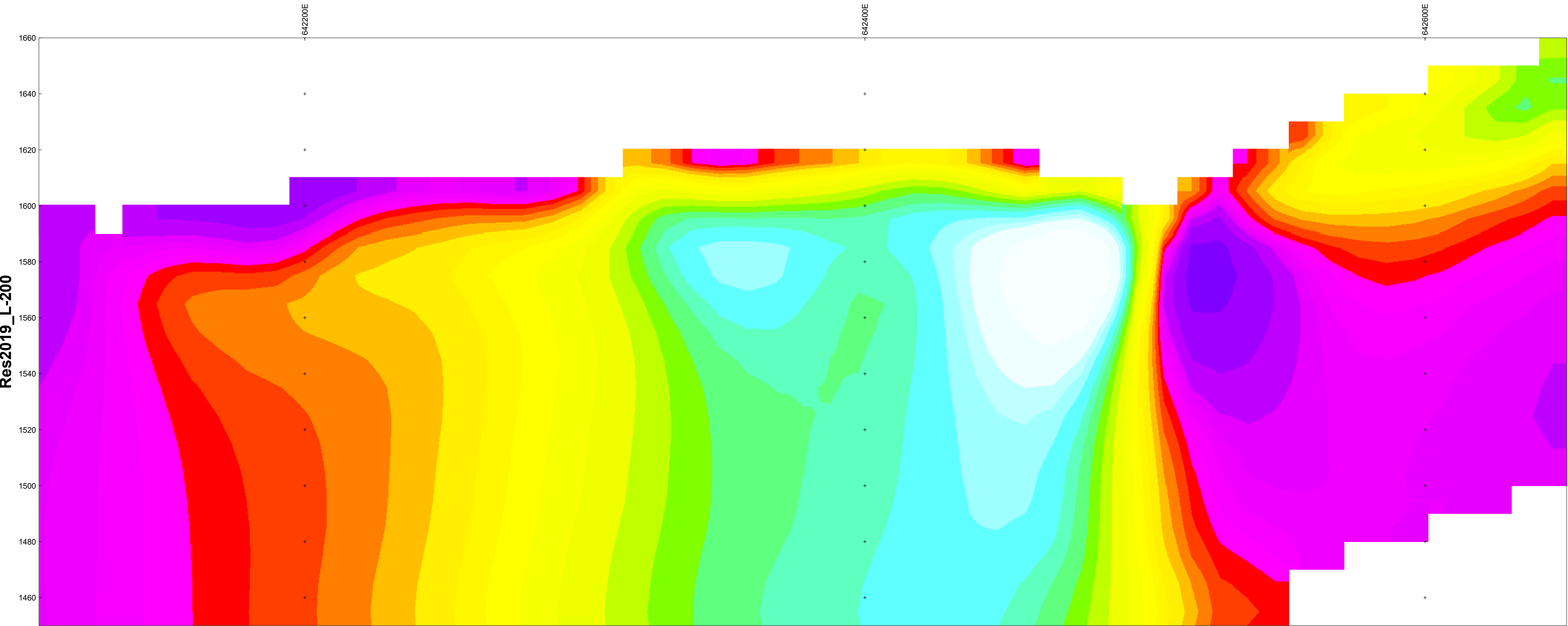

**GETTY COPPER
DC RESISTIVITY SURVEY**

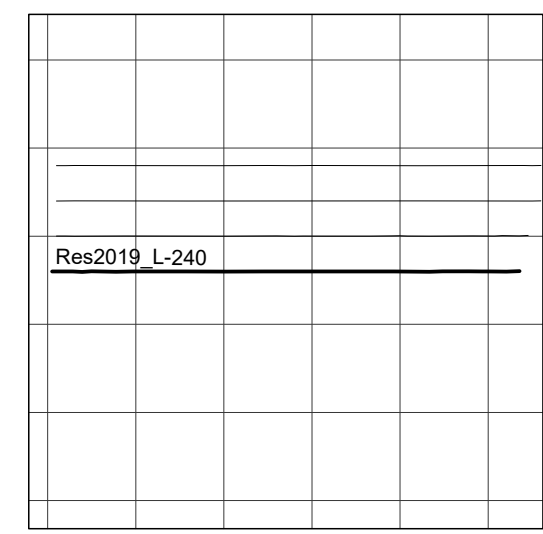
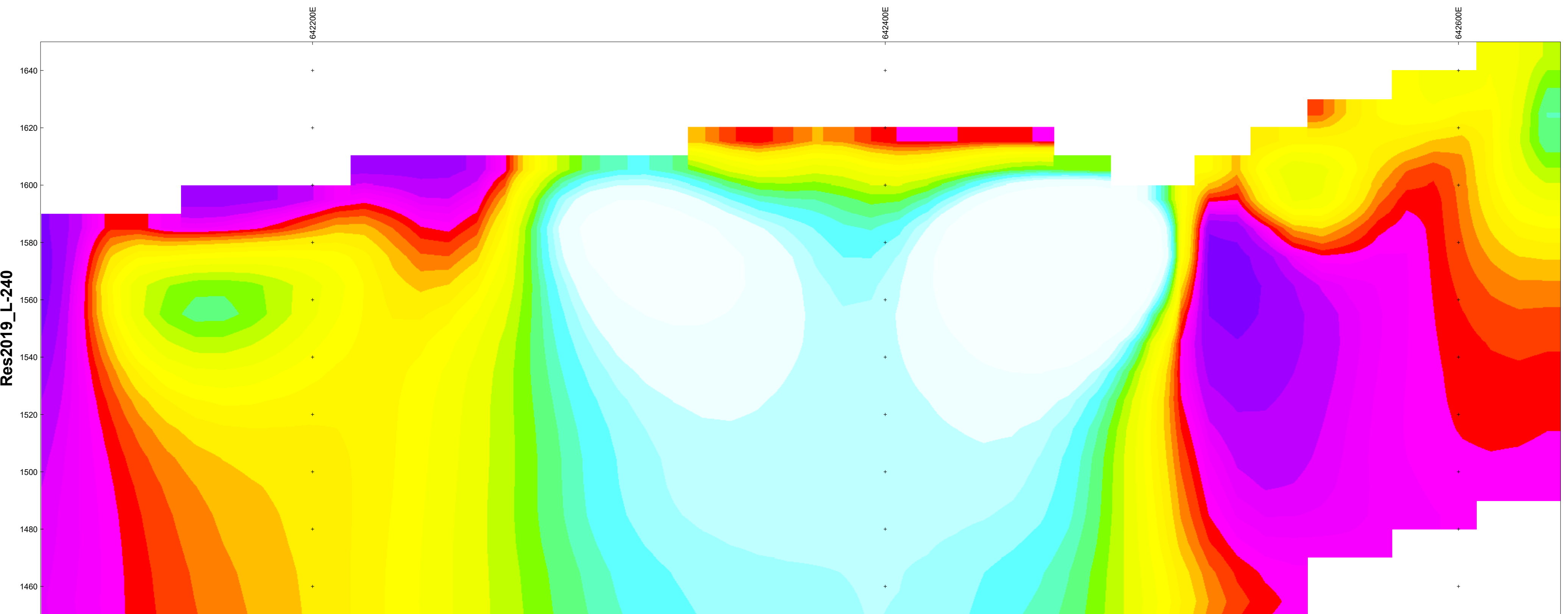

Section Trace Plan View

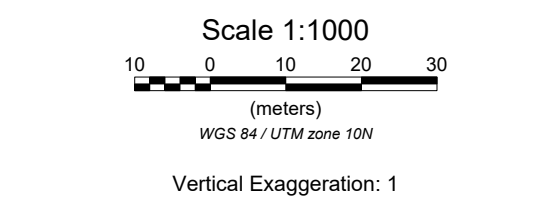
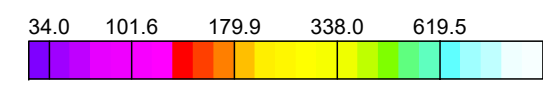

**GETTY COPPER
DC RESISTIVITY SURVEY**

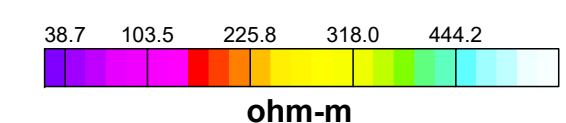
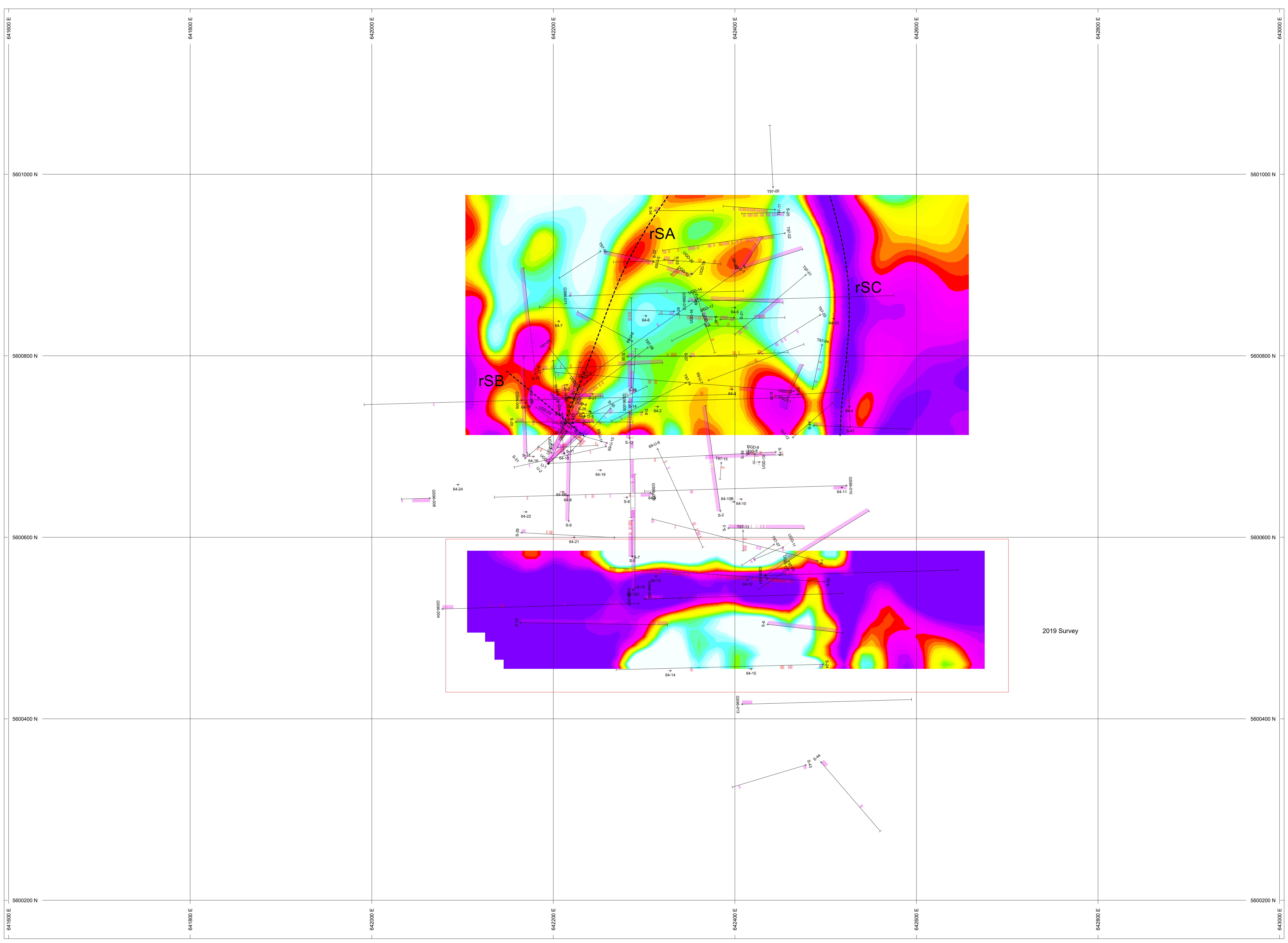

NUMBER BANDS	L/R	PATTERN	RANGE
Cu_per	R		0.5 to 1 1 to 9999

PLAN SPECS:
 REF. PT. E, N 642300 m 5601000 m
 EXTENTS 1410 m 1025 m

